

Мал. 2.98

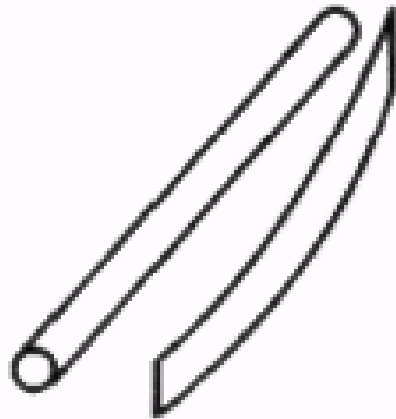

Мал. 2.99

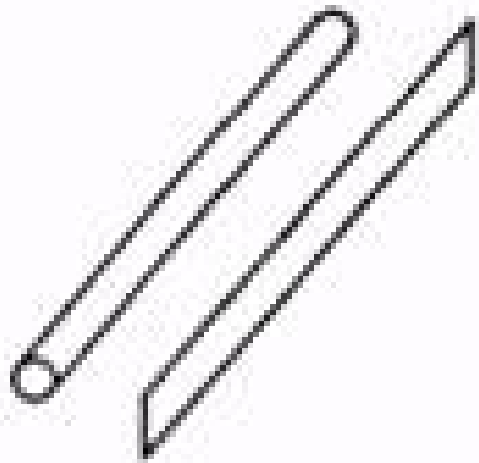

Мал. 2.98

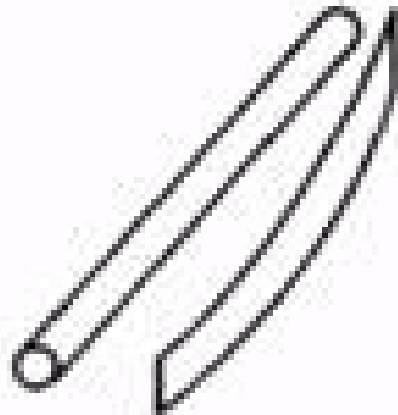

Мал. 2.99

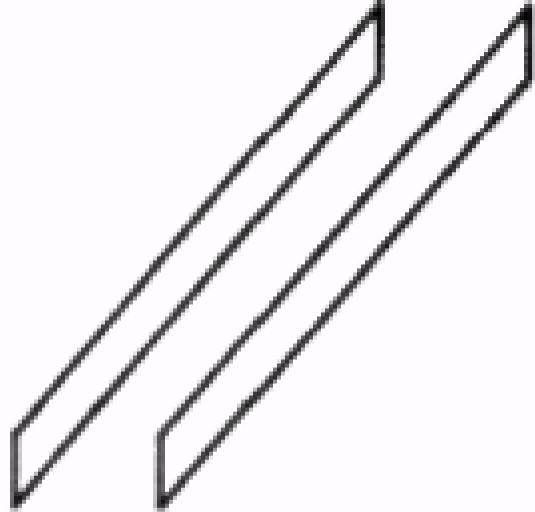

Мал. 2.100

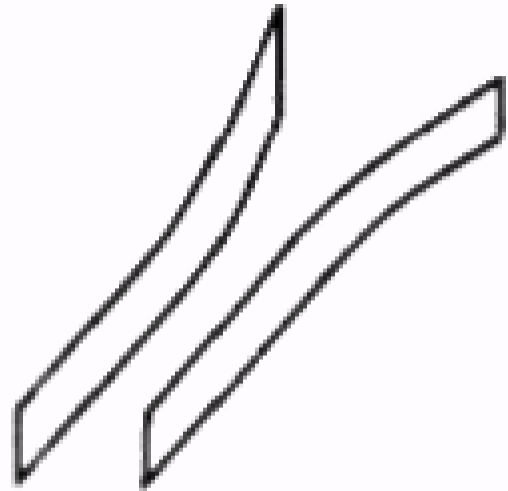

Мал. 2.101

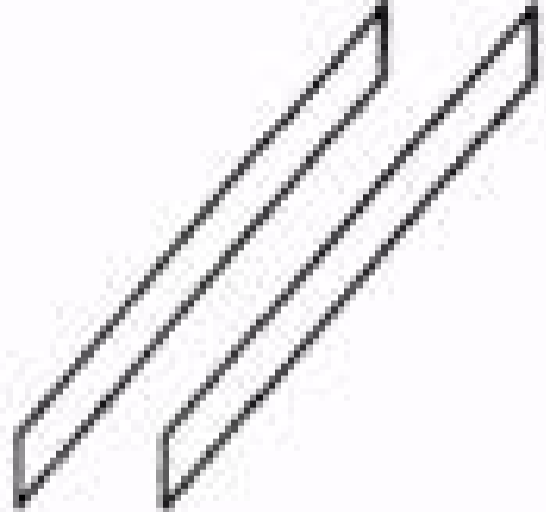

Мал. 2.100

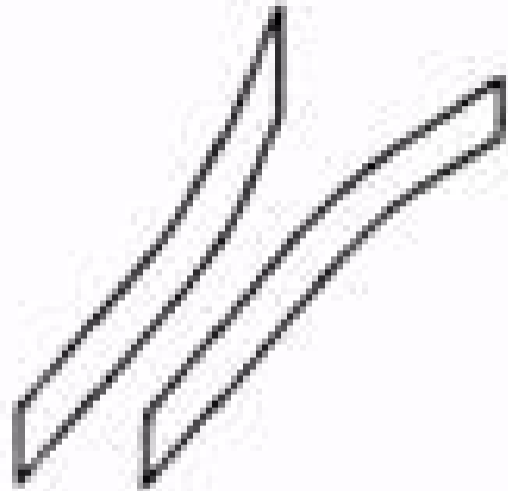

Мал. 2.101

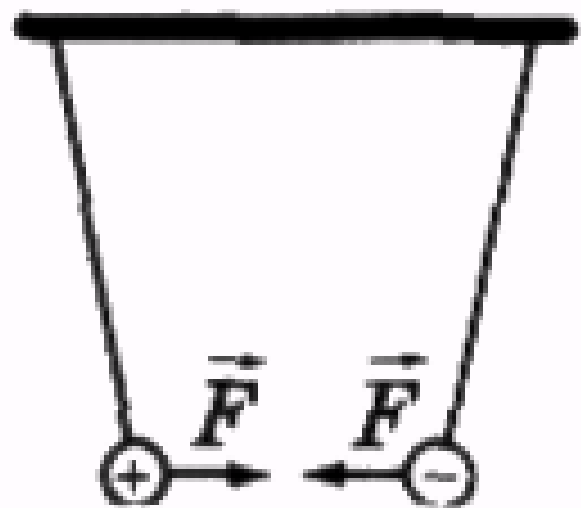
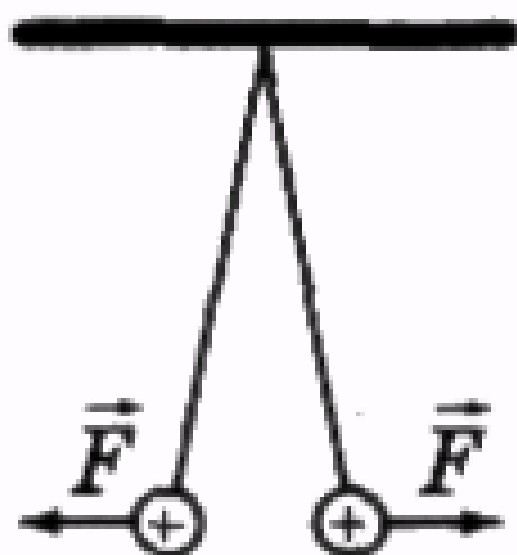
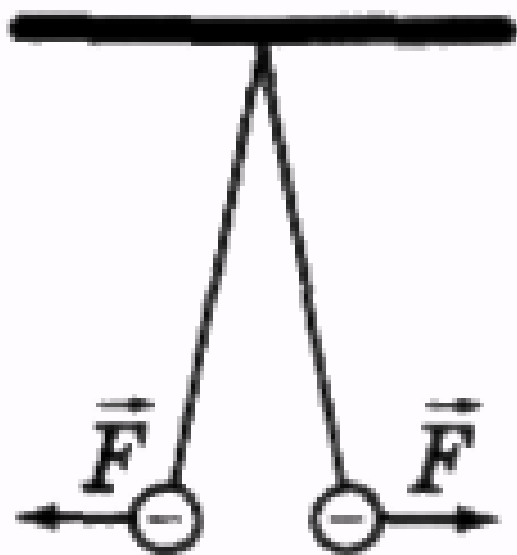

Мал. 2.102

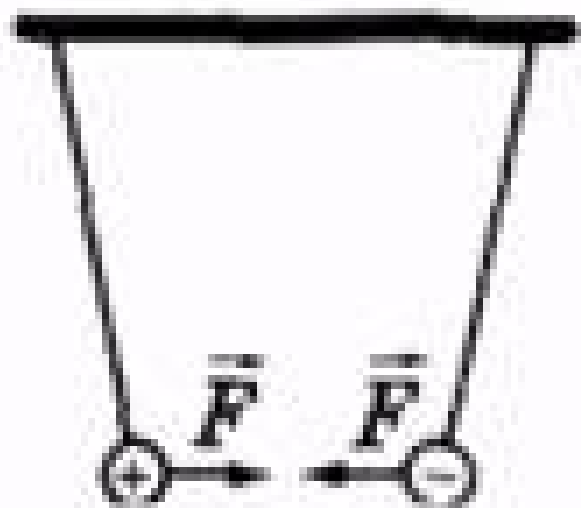
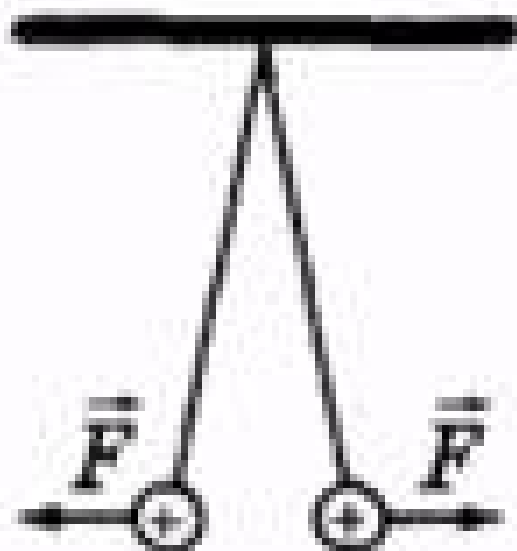
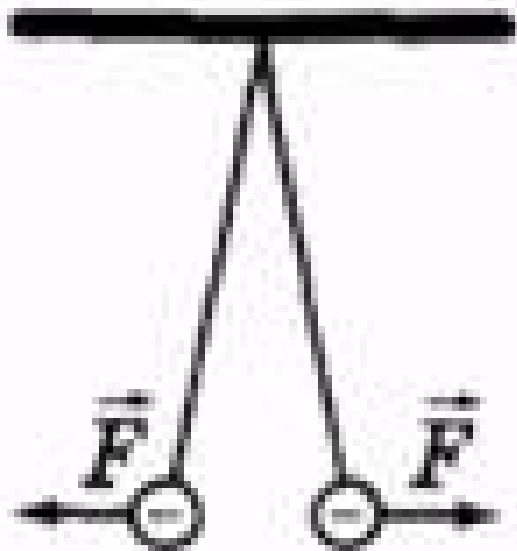

Мал. 2.102

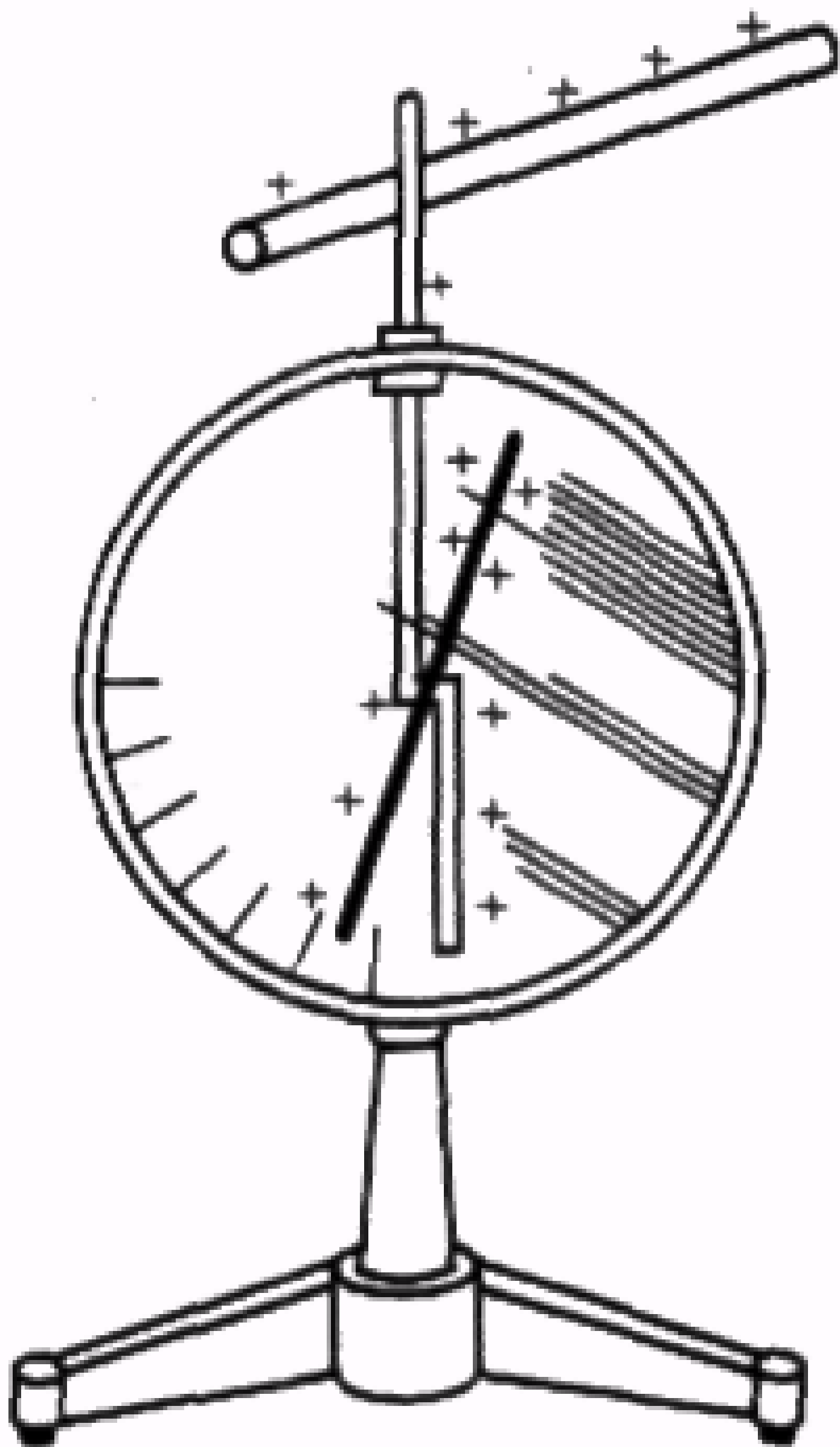

Мал. 2.103

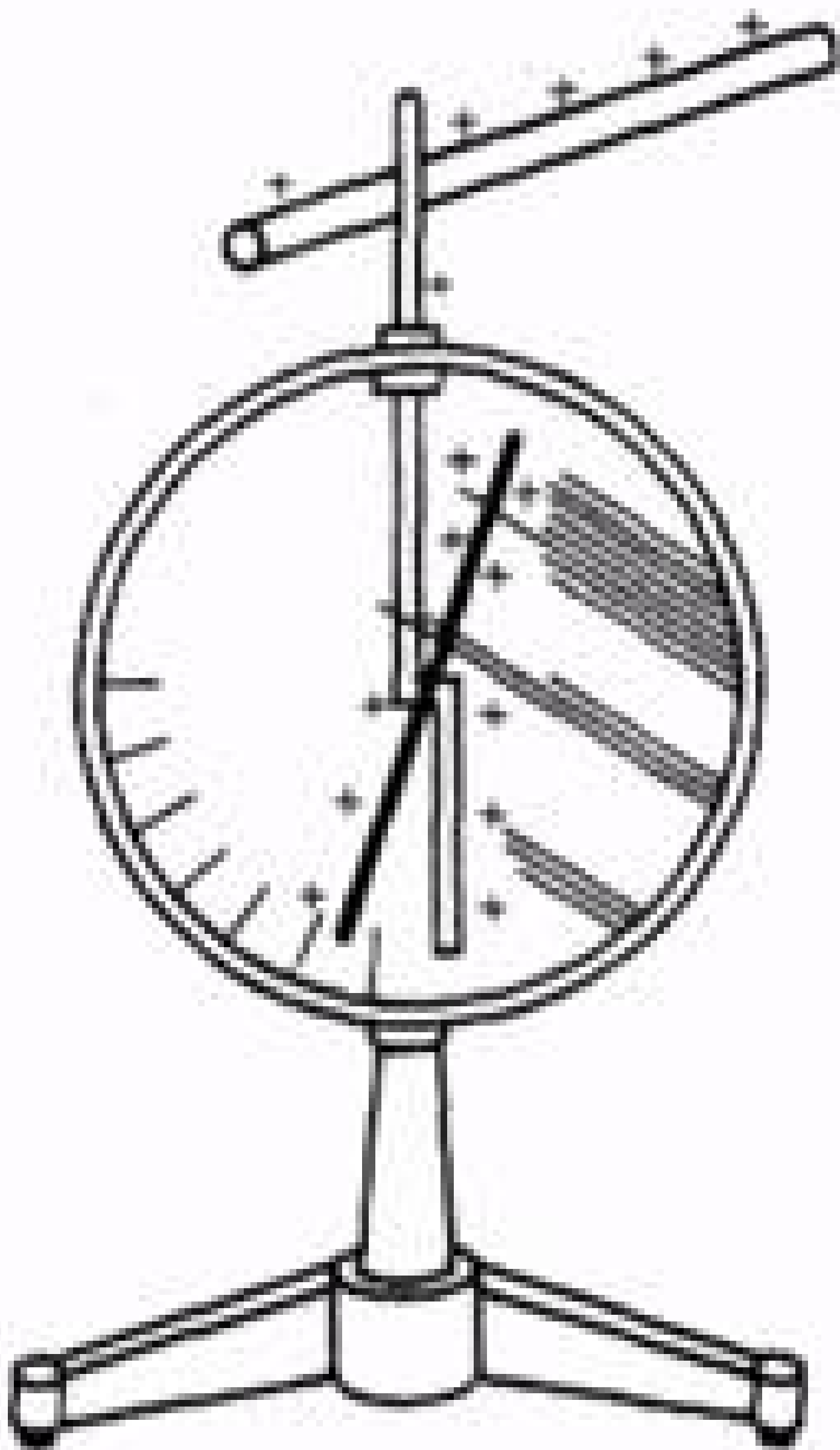

Маш. 2.103

$$Q_1 + Q_2 + \dots + Q_n = \text{const} \quad (34.1)$$

001

+

001

+

001

+

001

+

001

+

001

+

001

+

001

+

001

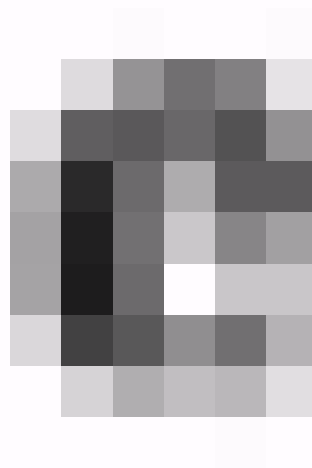



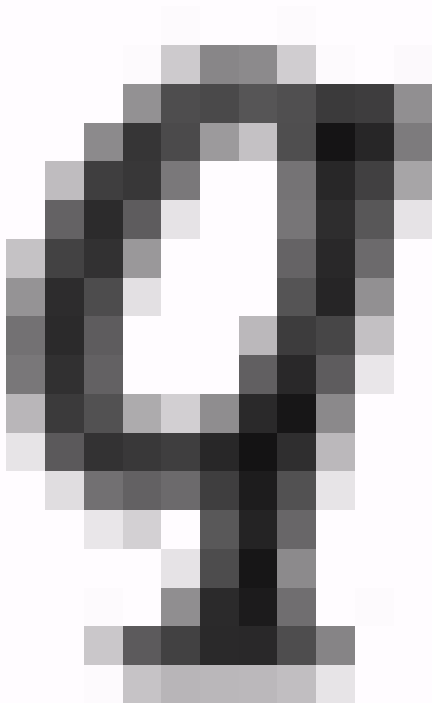
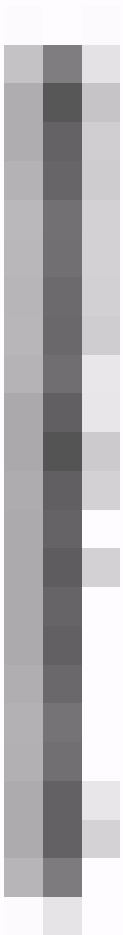

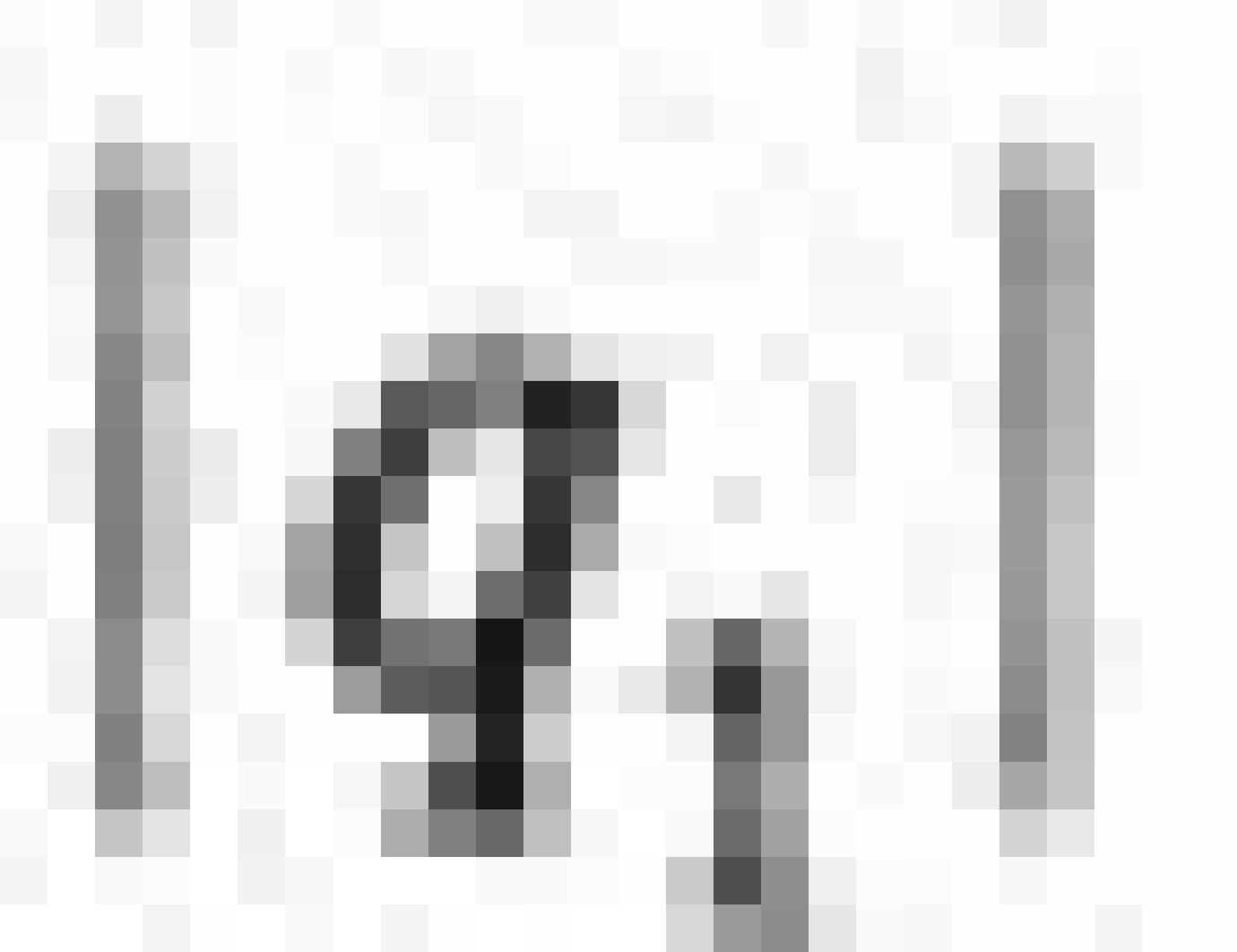





$$F_2 = R \frac{|q_1| \cdot |q_2|}{r^2} \quad (34.2)$$

$$A = \begin{bmatrix} 1 & 2 & 3 \\ 2 & 3 & 4 \\ 3 & 4 & 5 \end{bmatrix}$$

$$[1, 2, 3]$$

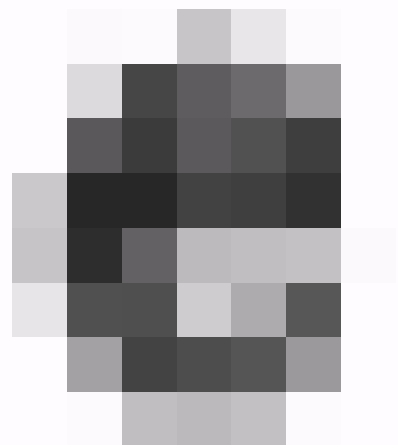

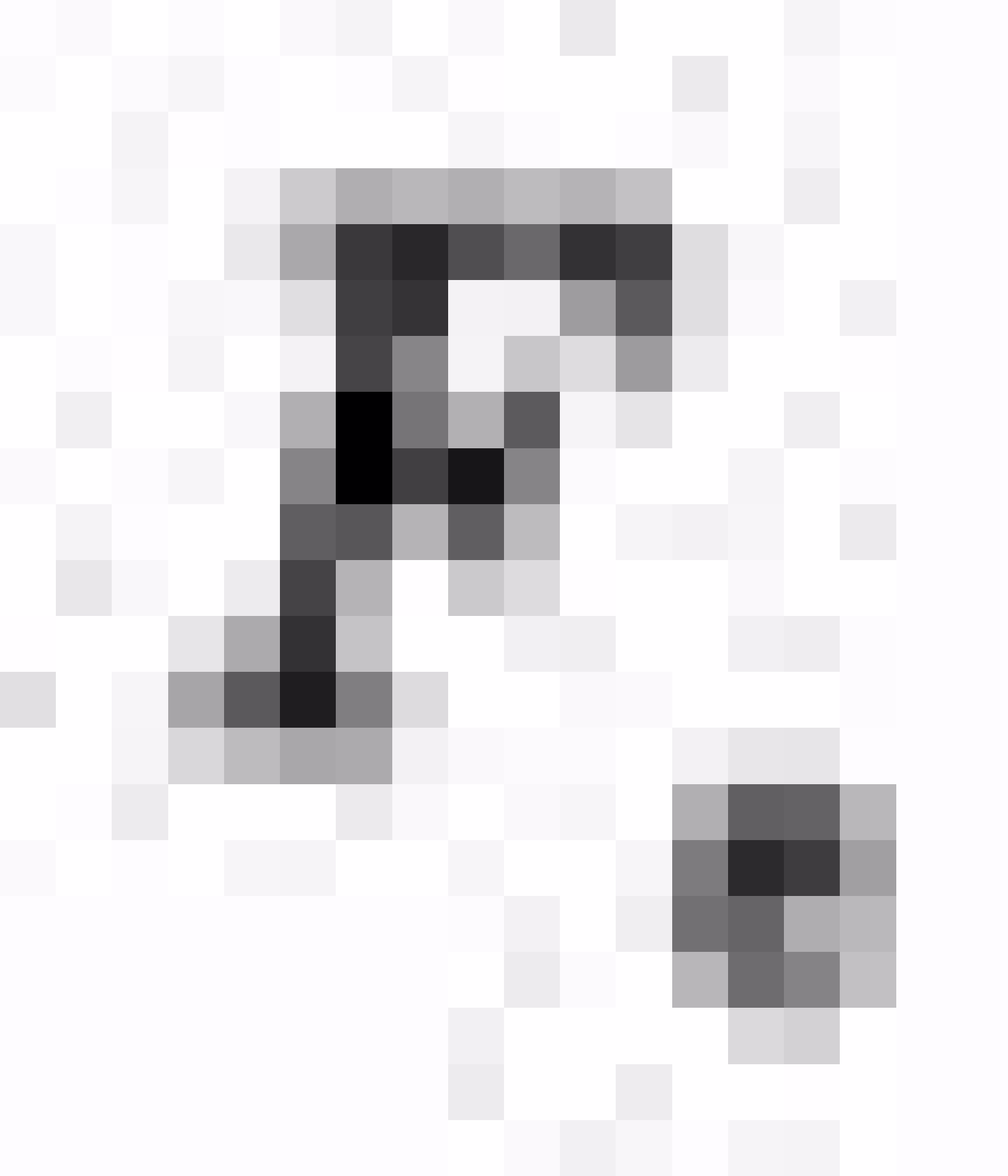

1. 2. 3. 4. 5. 6. 7. 8. 9. 10. 11. 12. 13. 14. 15. 16. 17. 18. 19. 20. 21. 22. 23. 24. 25. 26. 27. 28. 29. 30. 31. 32. 33. 34. 35. 36. 37. 38. 39. 40. 41. 42. 43. 44. 45. 46. 47. 48. 49. 50. 51. 52. 53. 54. 55. 56. 57. 58. 59. 60. 61. 62. 63. 64. 65. 66. 67. 68. 69. 70. 71. 72. 73. 74. 75. 76. 77. 78. 79. 80. 81. 82. 83. 84. 85. 86. 87. 88. 89. 90. 91. 92. 93. 94. 95. 96. 97. 98. 99. 100. 101. 102. 103. 104. 105. 106. 107. 108. 109. 110. 111. 112. 113. 114. 115. 116. 117. 118. 119. 120. 121. 122. 123. 124. 125. 126. 127. 128. 129. 130. 131. 132. 133. 134. 135. 136. 137. 138. 139. 140. 141. 142. 143. 144. 145. 146. 147. 148. 149. 150. 151. 152. 153. 154. 155. 156. 157. 158. 159. 160. 161. 162. 163. 164. 165. 166. 167. 168. 169. 170. 171. 172. 173. 174. 175. 176. 177. 178. 179. 180. 181. 182. 183. 184. 185. 186. 187. 188. 189. 190. 191. 192. 193. 194. 195. 196. 197. 198. 199. 200. 201. 202. 203. 204. 205. 206. 207. 208. 209. 210. 211. 212. 213. 214. 215. 216. 217. 218. 219. 220. 221. 222. 223. 224. 225. 226. 227. 228. 229. 230. 231. 232. 233. 234. 235. 236. 237. 238. 239. 240. 241. 242. 243. 244. 245. 246. 247. 248. 249. 250. 251. 252. 253. 254. 255. 256. 257. 258. 259. 260. 261. 262. 263. 264. 265. 266. 267. 268. 269. 270. 271. 272. 273. 274. 275. 276. 277. 278. 279. 280. 281. 282. 283. 284. 285. 286. 287. 288. 289. 290. 291. 292. 293. 294. 295. 296. 297. 298. 299. 300. 301. 302. 303. 304. 305. 306. 307. 308. 309. 310. 311. 312. 313. 314. 315. 316. 317. 318. 319. 320. 321. 322. 323. 324. 325. 326. 327. 328. 329. 330. 331. 332. 333. 334. 335. 336. 337. 338. 339. 340. 341. 342. 343. 344. 345. 346. 347. 348. 349. 350. 351. 352. 353. 354. 355. 356. 357. 358. 359. 360. 361. 362. 363. 364. 365. 366. 367. 368. 369. 370. 371. 372. 373. 374. 375. 376. 377. 378. 379. 380. 381. 382. 383. 384. 385. 386. 387. 388. 389. 390. 391. 392. 393. 394. 395. 396. 397. 398. 399. 400. 401. 402. 403. 404. 405. 406. 407. 408. 409. 410. 411. 412. 413. 414. 415. 416. 417. 418. 419. 420. 421. 422. 423. 424. 425. 426. 427. 428. 429. 430. 431. 432. 433. 434. 435. 436. 437. 438. 439. 440. 441. 442. 443. 444. 445. 446. 447. 448. 449. 450. 451. 452. 453. 454. 455. 456. 457. 458. 459. 460. 461. 462. 463. 464. 465. 466. 467. 468. 469. 470. 471. 472. 473. 474. 475. 476. 477. 478. 479. 480. 481. 482. 483. 484. 485. 486. 487. 488. 489. 490. 491. 492. 493. 494. 495. 496. 497. 498. 499. 500. 501. 502. 503. 504. 505. 506. 507. 508. 509. 510. 511. 512. 513. 514. 515. 516. 517. 518. 519. 520. 521. 522. 523. 524. 525. 526. 527. 528. 529. 530. 531. 532. 533. 534. 535. 536. 537. 538. 539. 540. 541. 542. 543. 544. 545. 546. 547. 548. 549. 550. 551. 552. 553. 554. 555. 556. 557. 558. 559. 560. 561. 562. 563. 564. 565. 566. 567. 568. 569. 570. 571. 572. 573. 574. 575. 576. 577. 578. 579. 580. 581. 582. 583. 584. 585. 586. 587. 588. 589. 590. 591. 592. 593. 594. 595. 596. 597. 598. 599. 600. 601. 602. 603. 604. 605. 606. 607. 608. 609. 610. 611. 612. 613. 614. 615. 616. 617. 618. 619. 620. 621. 622. 623. 624. 625. 626. 627. 628. 629. 630. 631. 632. 633. 634. 635. 636. 637. 638. 639. 640. 641. 642. 643. 644. 645. 646. 647. 648. 649. 650. 651. 652. 653. 654. 655. 656. 657. 658. 659. 660. 661. 662. 663. 664. 665. 666. 667. 668. 669. 670. 671. 672. 673. 674. 675. 676. 677. 678. 679. 680. 681. 682. 683. 684. 685. 686. 687. 688. 689. 690. 691. 692. 693. 694. 695. 696. 697. 698. 699. 700. 701. 702. 703. 704. 705. 706. 707. 708. 709. 710. 711. 712. 713. 714. 715. 716. 717. 718. 719. 720. 721. 722. 723. 724. 725. 726. 727. 728. 729. 730. 731. 732. 733. 734. 735. 736. 737. 738. 739. 740. 741. 742. 743. 744. 745. 746. 747. 748. 749. 750. 751. 752. 753. 754. 755. 756. 757. 758. 759. 760. 761. 762. 763. 764. 765. 766. 767. 768. 769. 770. 771. 772. 773. 774. 775. 776. 777. 778. 779. 780. 781. 782. 783. 784. 785. 786. 787. 788. 789. 790. 791. 792. 793. 794. 795. 796. 797. 798. 799. 800. 801. 802. 803. 804. 805. 806. 807. 808. 809. 810. 811. 812. 813. 814. 815. 816. 817. 818. 819. 820. 821. 822. 823. 824. 825. 826. 827. 828. 829. 830. 831. 832. 833. 834. 835. 836. 837. 838. 839. 840. 841. 842. 843. 844. 845. 846. 847. 848. 849. 850. 851. 852. 853. 854. 855. 856. 857. 858. 859. 860. 861. 862. 863. 864. 865. 866. 867. 868. 869. 870. 871. 872. 873. 874. 875. 876. 877. 878. 879. 880. 881. 882. 883. 884. 885. 886. 887. 888. 889. 890. 891. 892. 893. 894. 895. 896. 897. 898. 899. 900. 901. 902. 903. 904. 905. 906. 907. 908. 909. 910. 911. 912. 913. 914. 915. 916. 917. 918. 919. 920. 921. 922. 923. 924. 925. 926. 927. 928. 929. 930. 931. 932. 933. 934. 935. 936. 937. 938. 939. 940. 941. 942. 943. 944. 945. 946. 947. 948. 949. 950. 951. 952. 953. 954. 955. 956. 957. 958. 959. 960. 961. 962. 963. 964. 965. 966. 967. 968. 969. 970. 971. 972. 973. 974. 975. 976. 977. 978. 979. 980. 981. 982. 983. 984. 985. 986. 987. 988. 989. 990. 991. 992. 993. 994. 995. 996. 997. 998. 999. 1000.

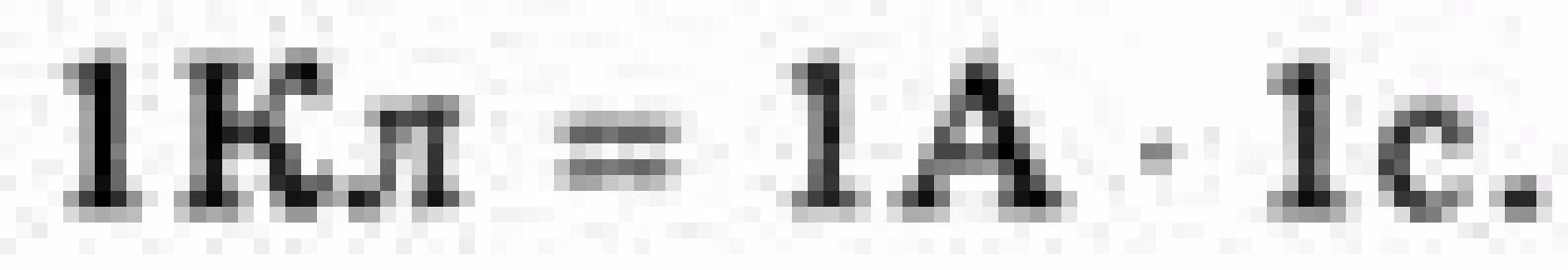

As = 90
100
110
120

WORLDWIDE
WORLDWIDE

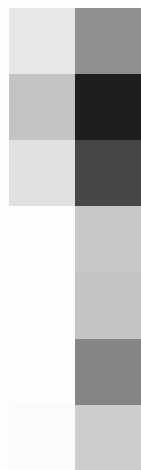
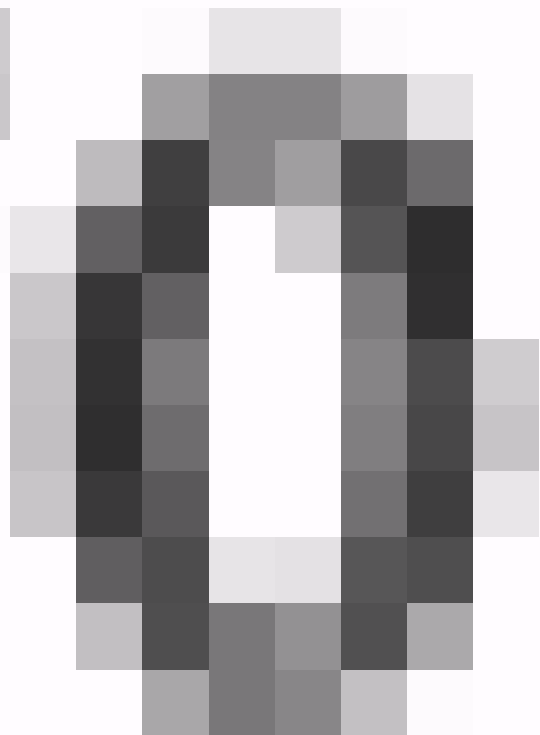
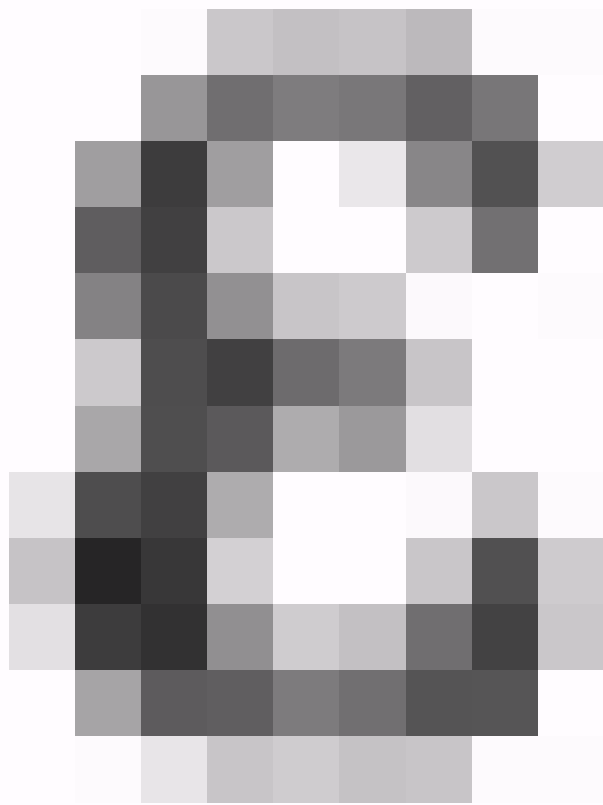

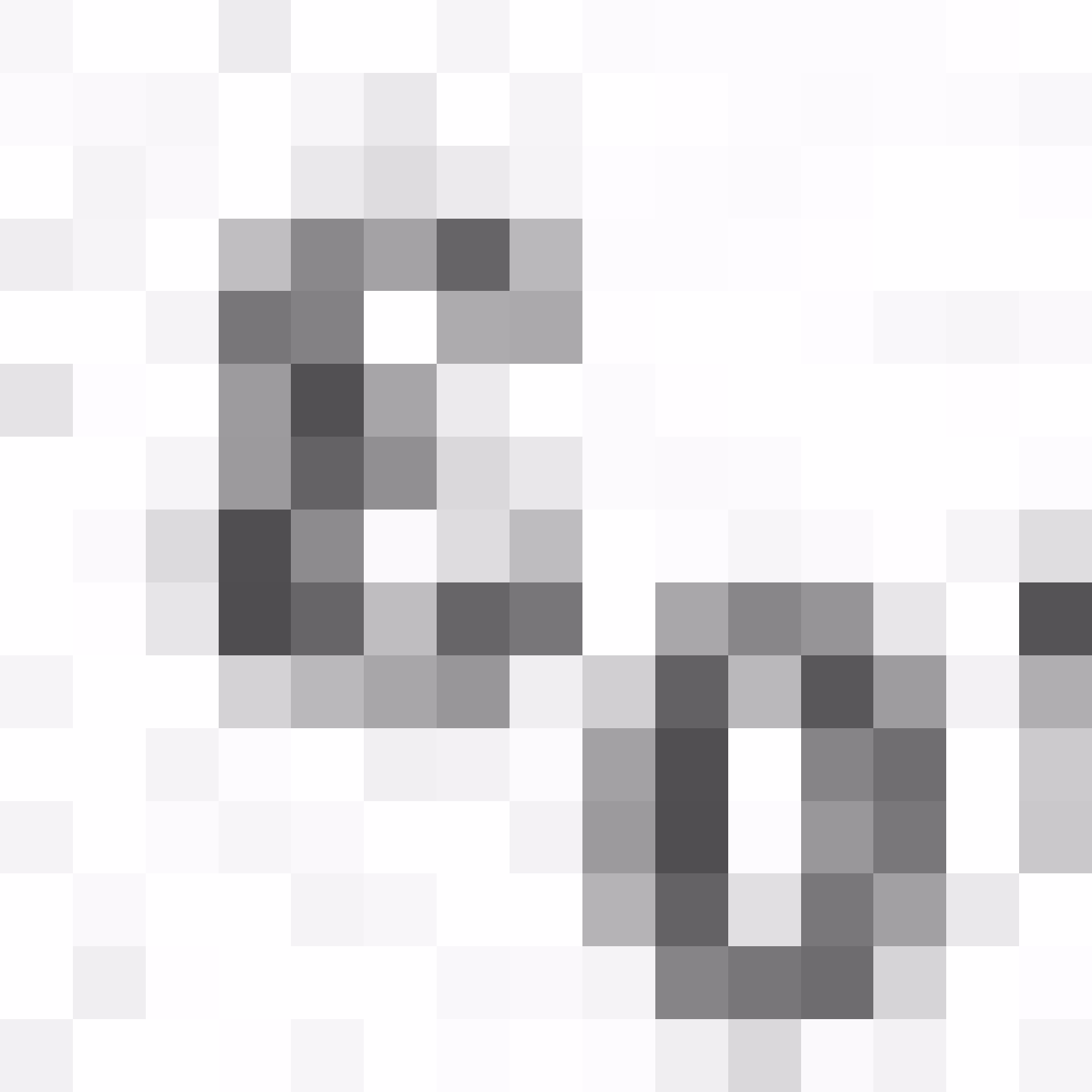

$$\epsilon_0 = \frac{1}{4\pi k_e} \quad (34.3)$$



1941

EO =

OB, OB, OB

10-12

RM2/RI

MI

THE UNIVERSITY OF
MICHIGAN LIBRARIES
SERIALS ACQUISITION
300 NORTH ZEEB ROAD
ANN ARBOR MI 48106-1500
TEL: 734 763 1000
WWW.LIBRARIES.UMICH.EDU

$$F_1 = \frac{1}{4\pi\epsilon_0} \cdot \frac{|q_1| \cdot |q_2|}{r^2} \quad (34.4)$$

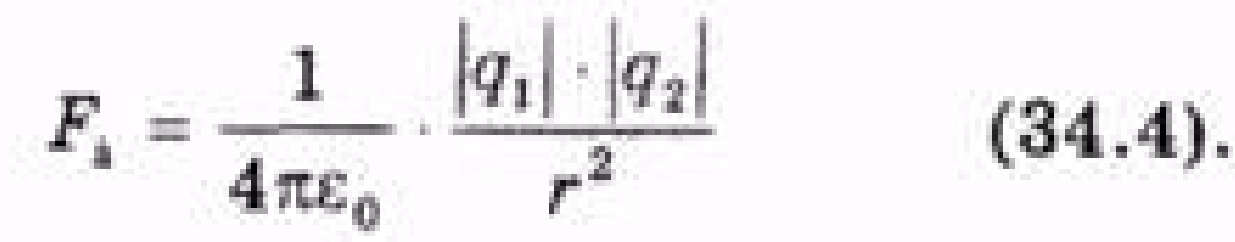

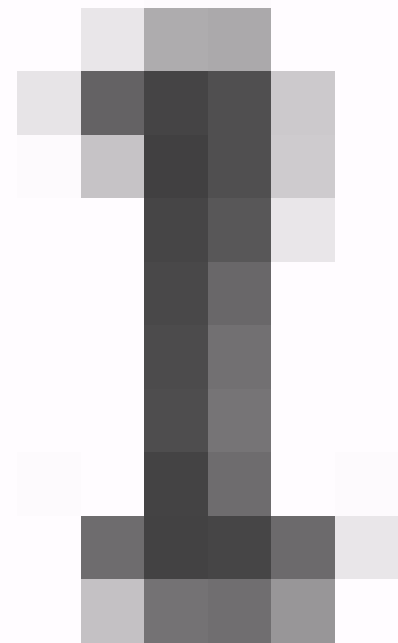
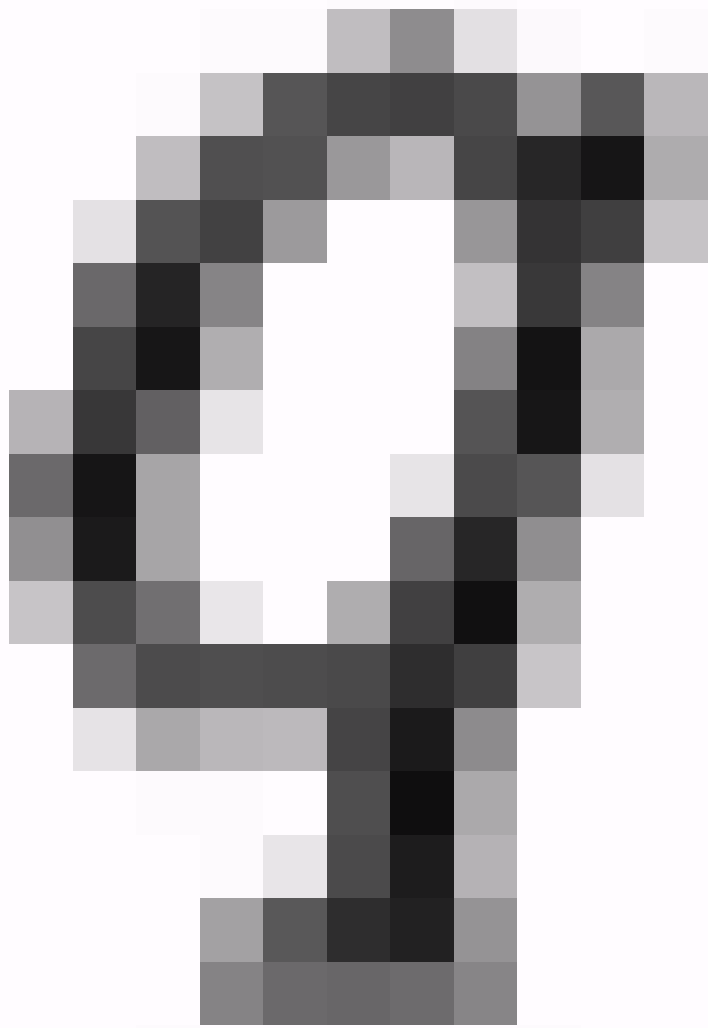

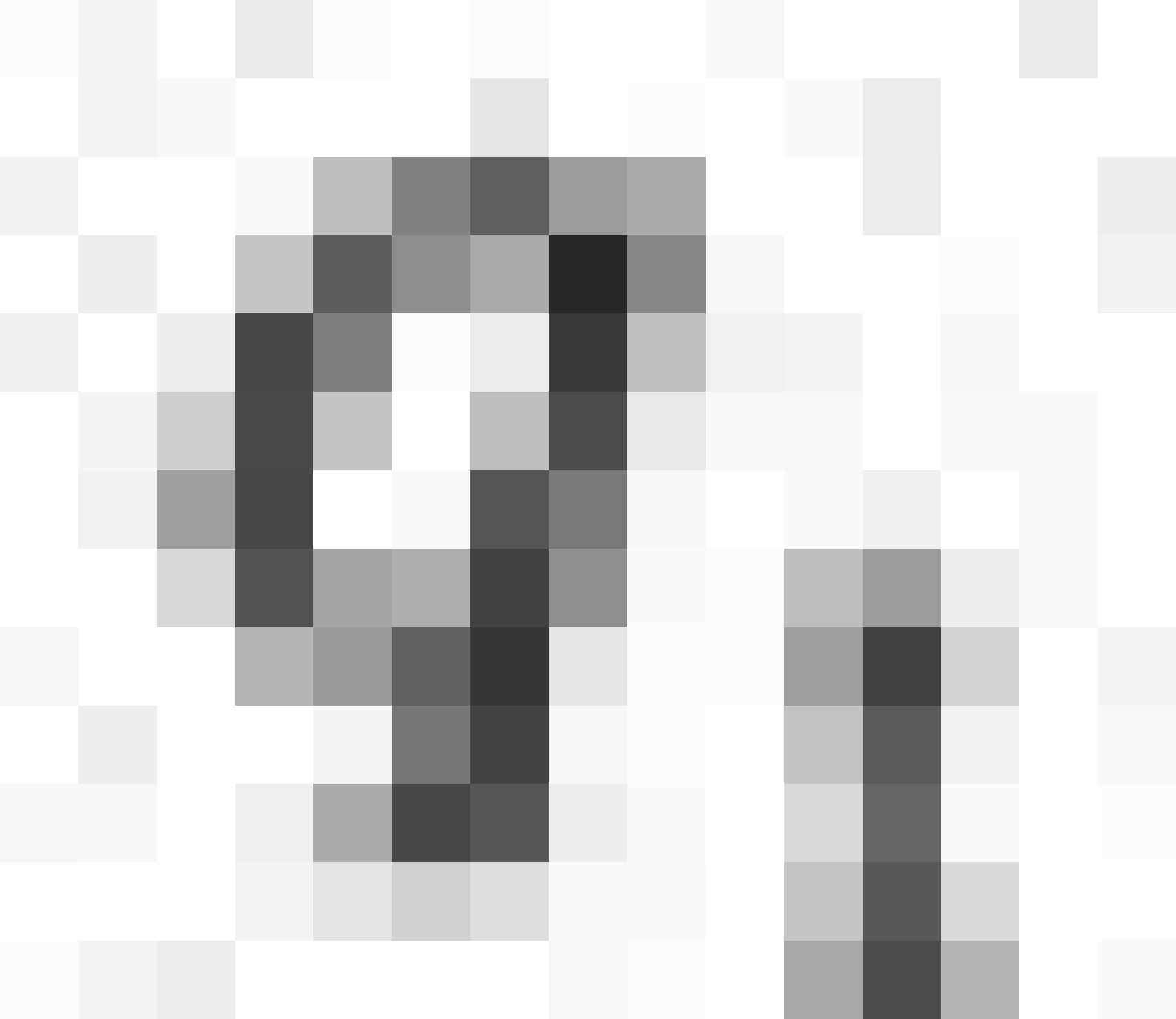

F_0 $=$ R

$$\frac{Q_1 + Q_2}{r_2}$$



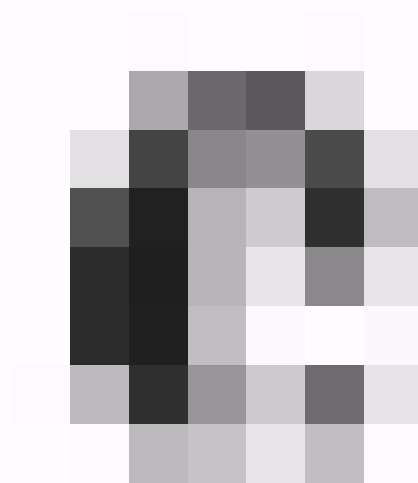



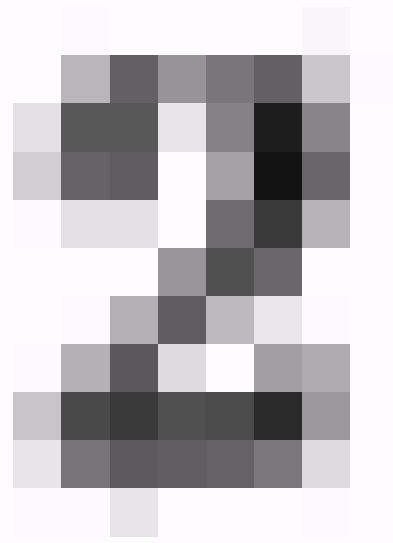
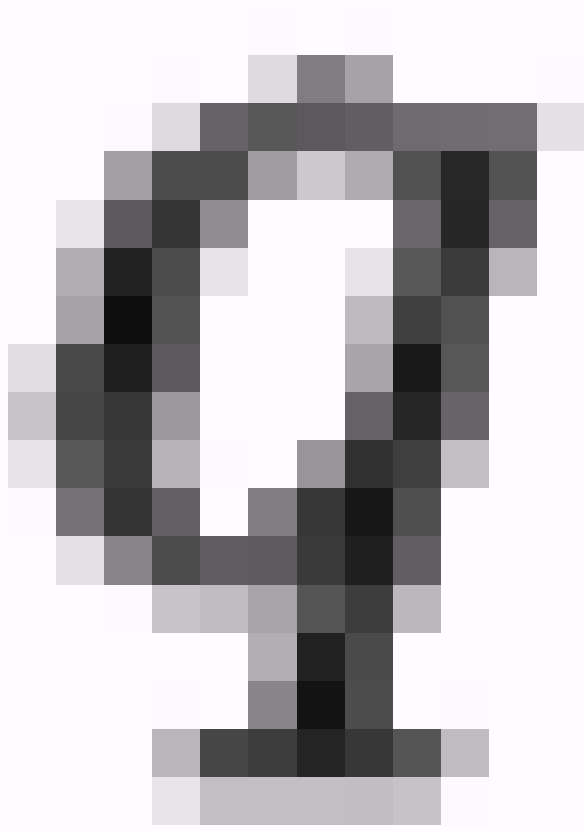

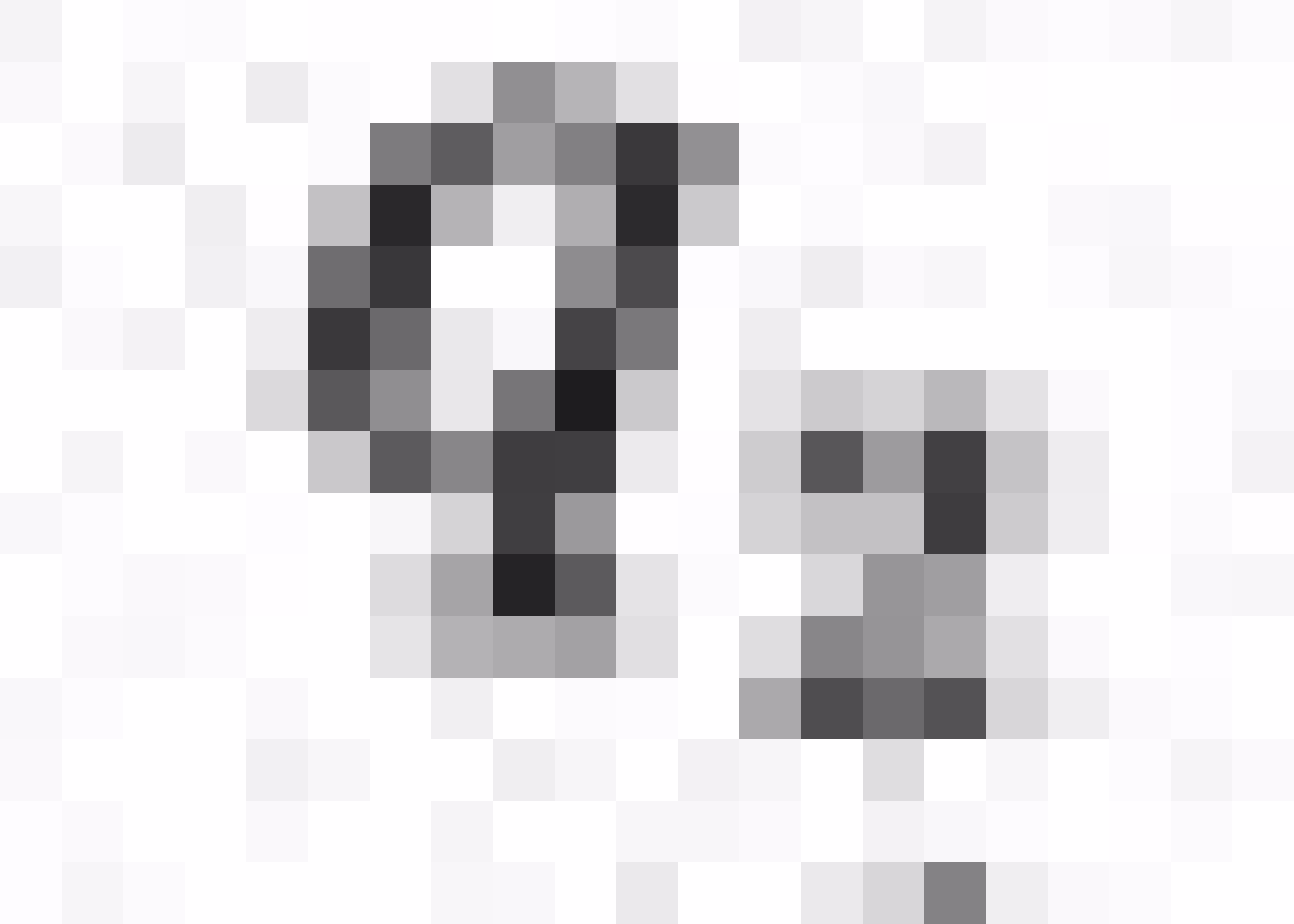

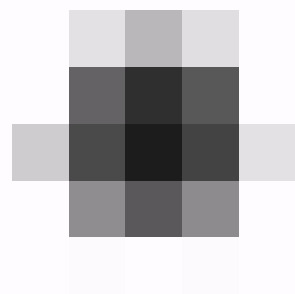
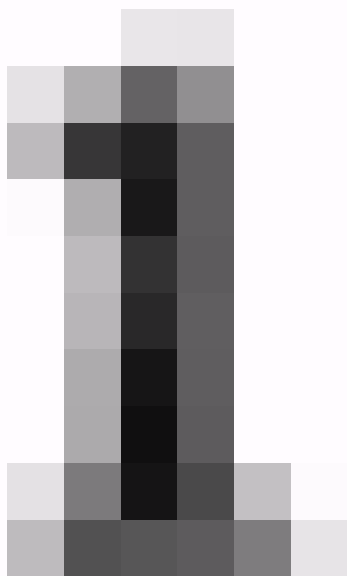
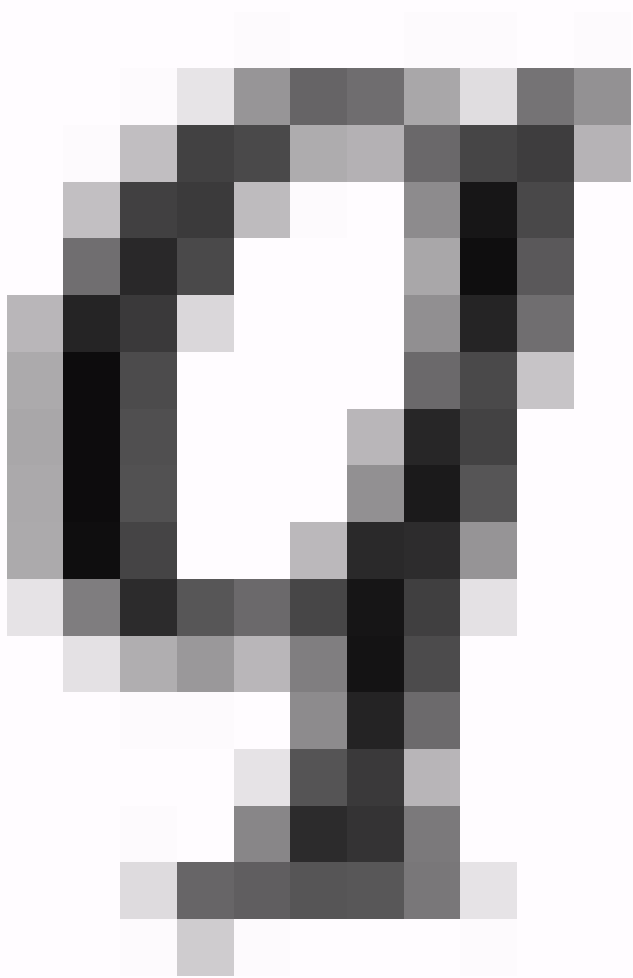

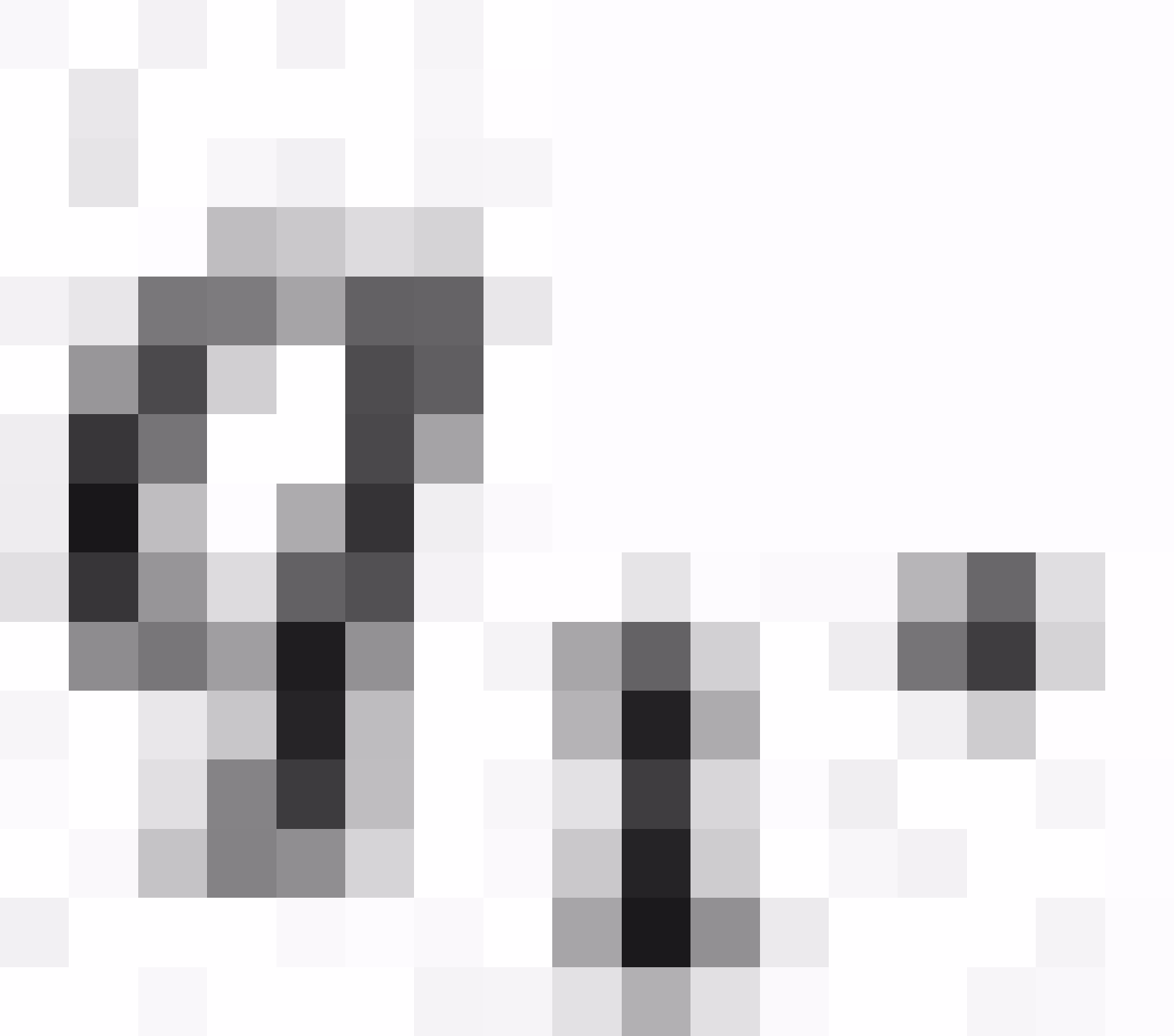

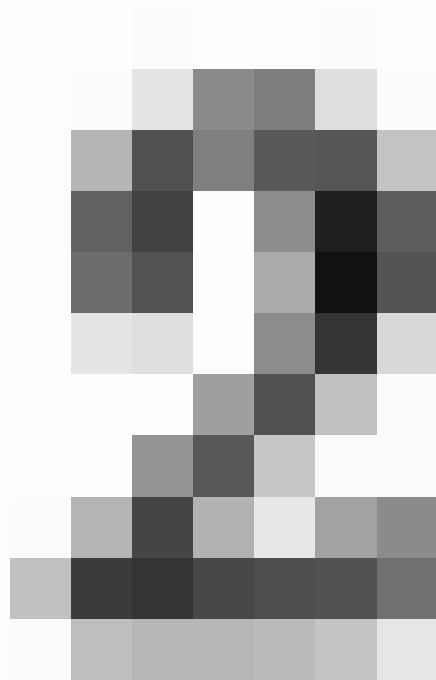
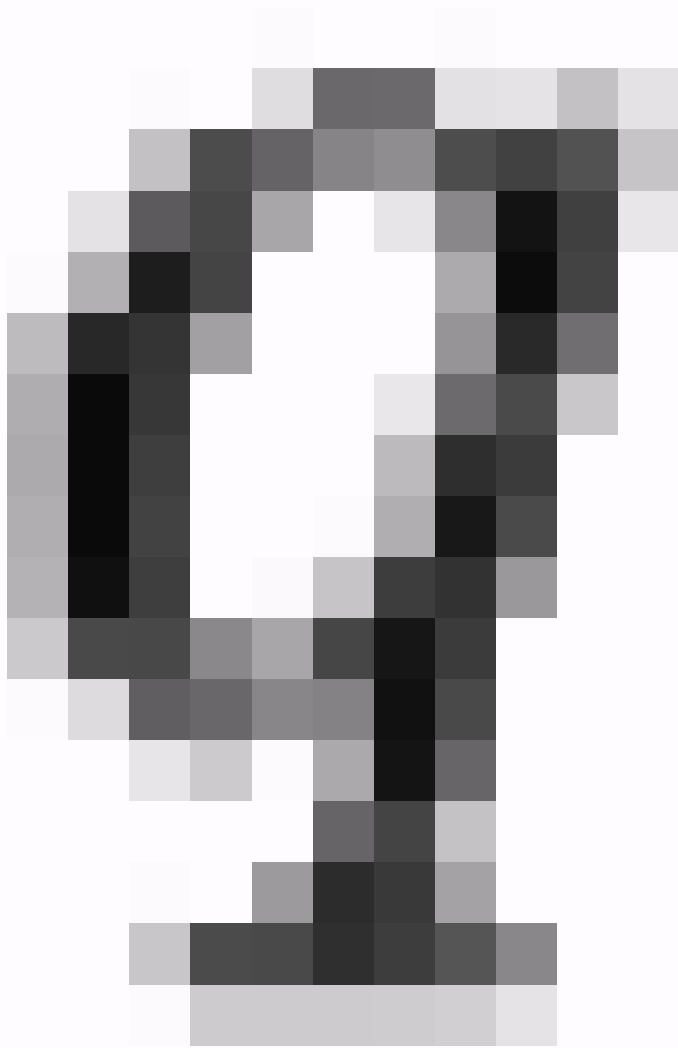

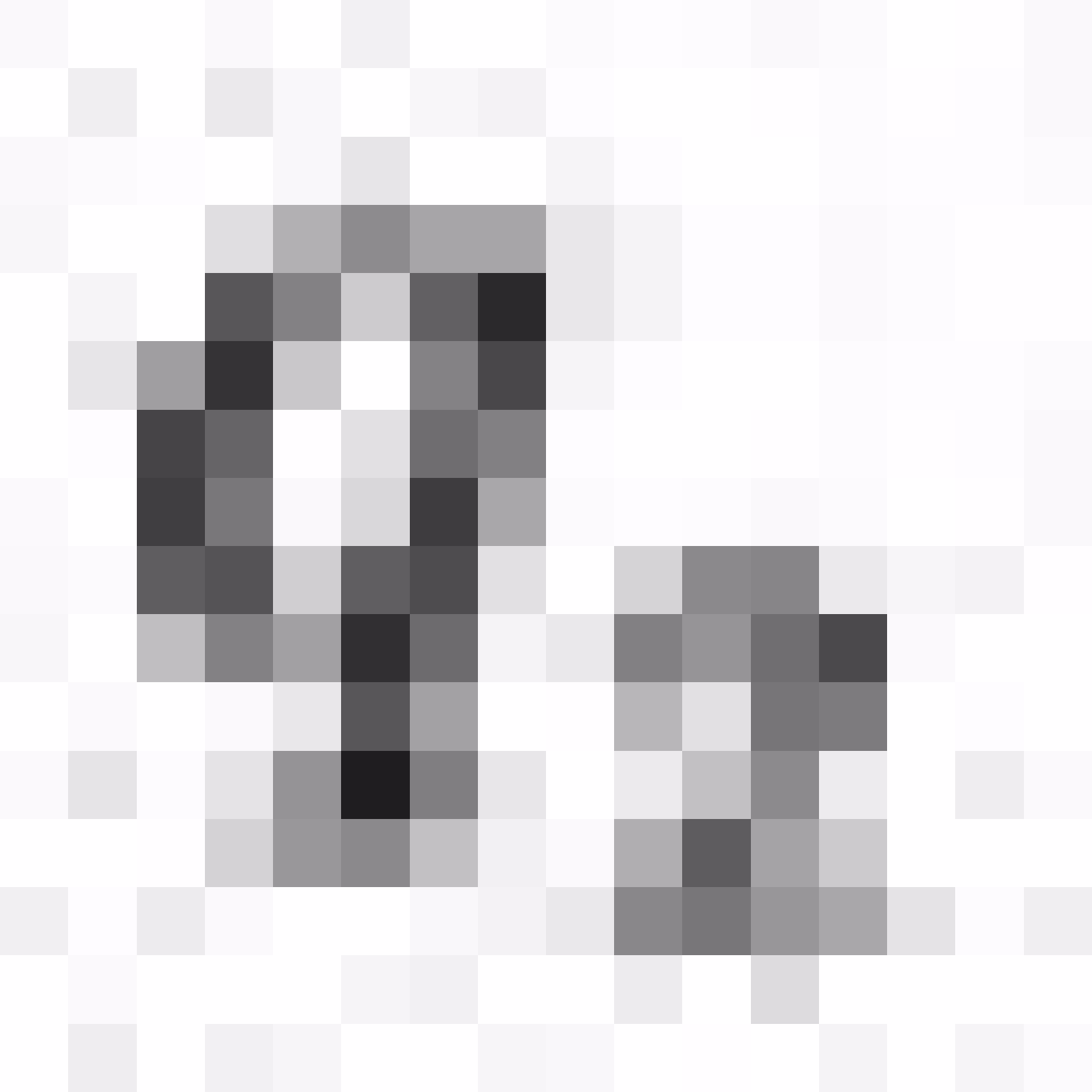

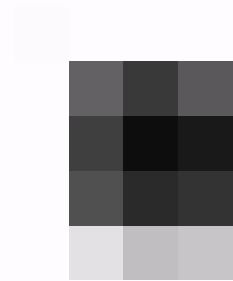
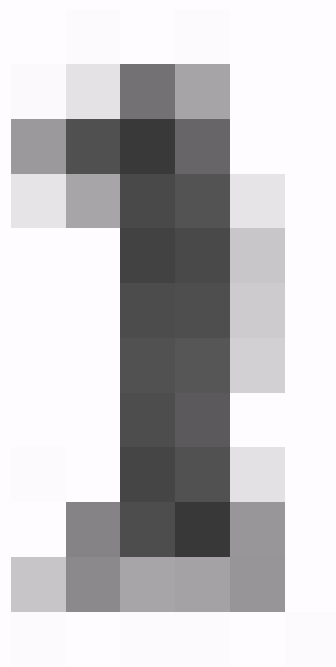
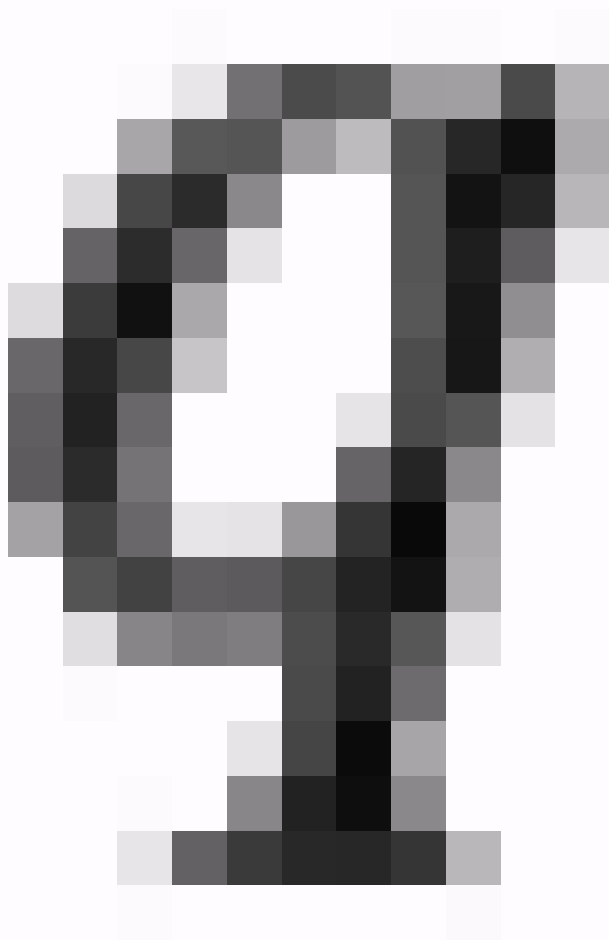

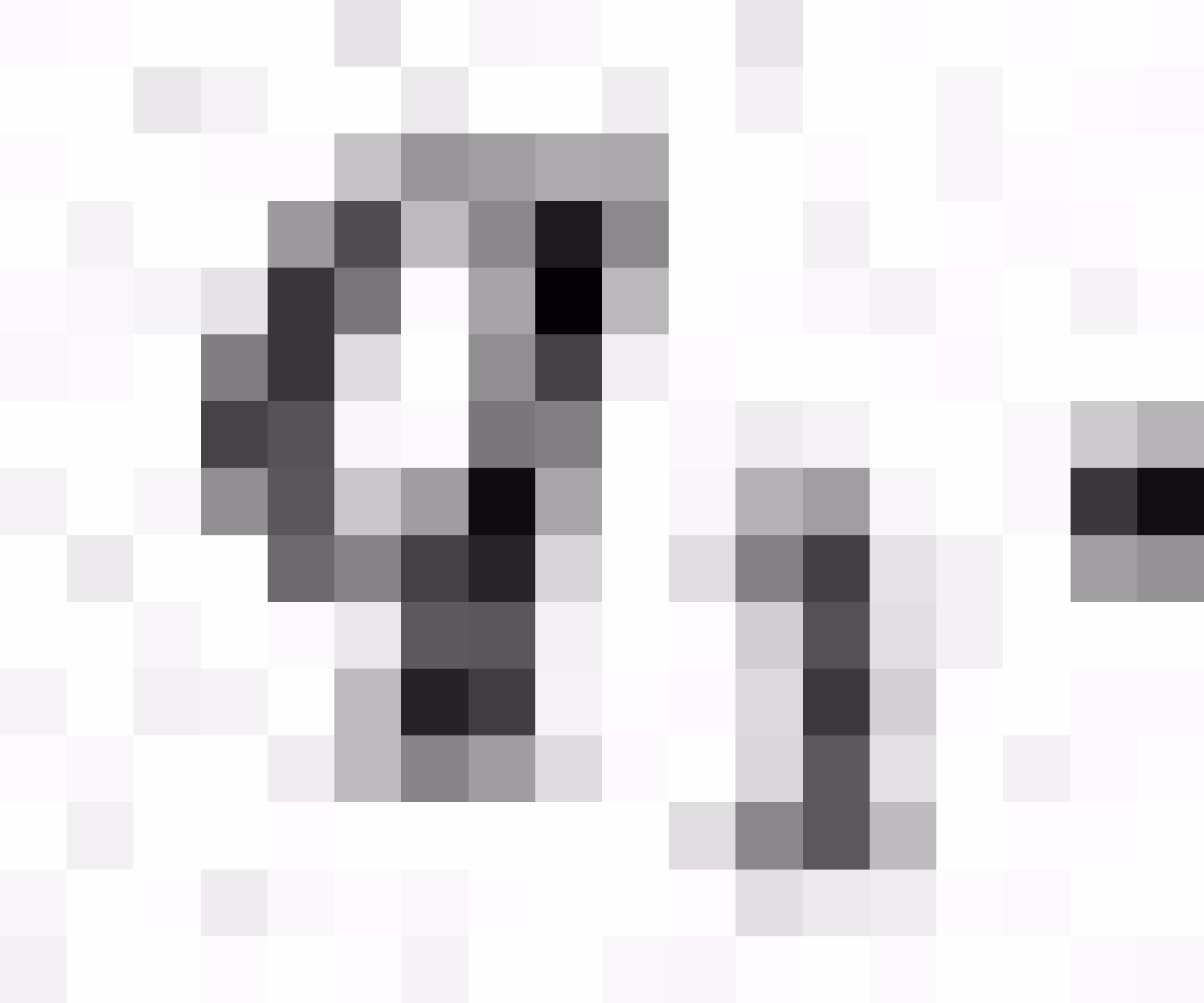

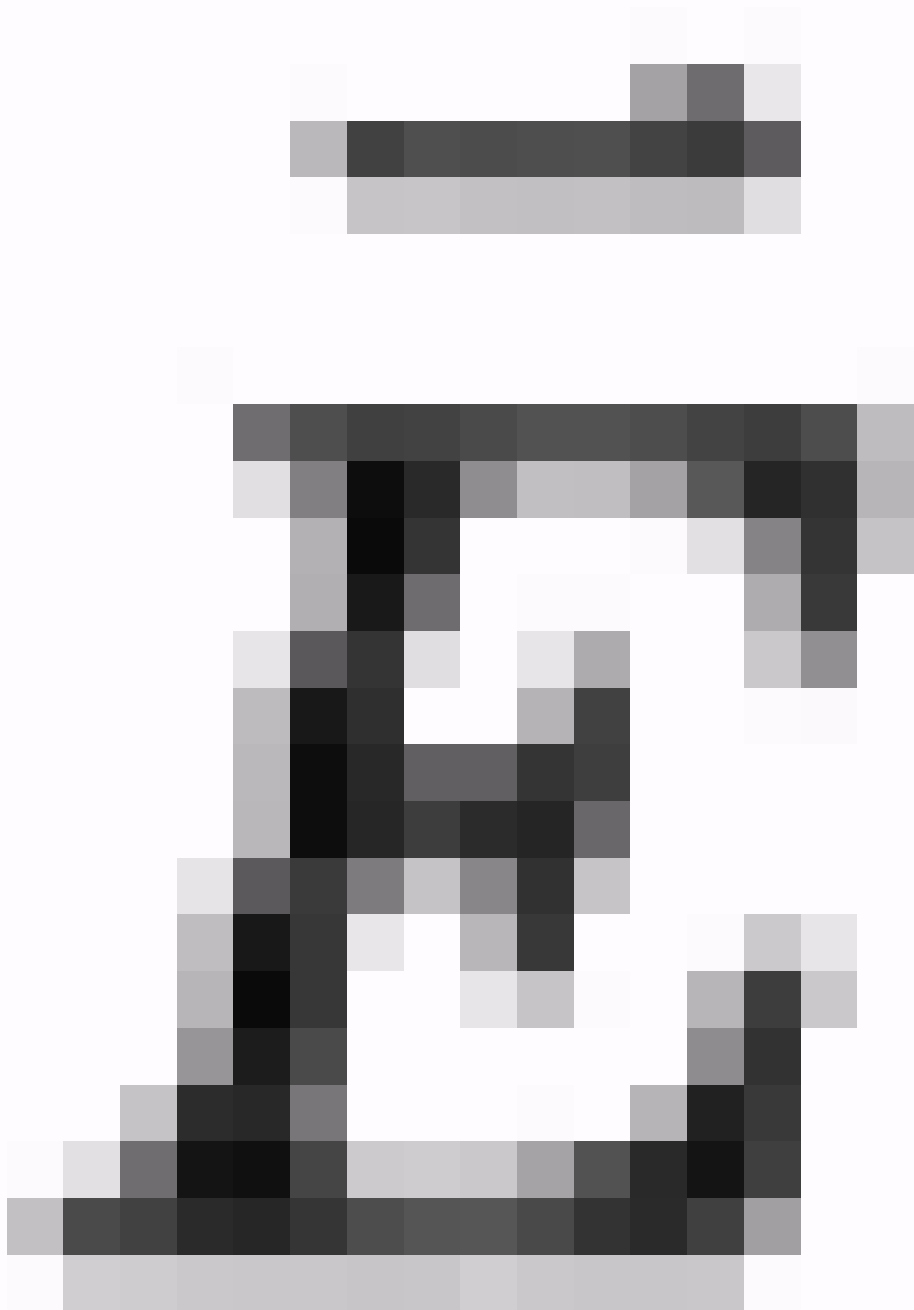





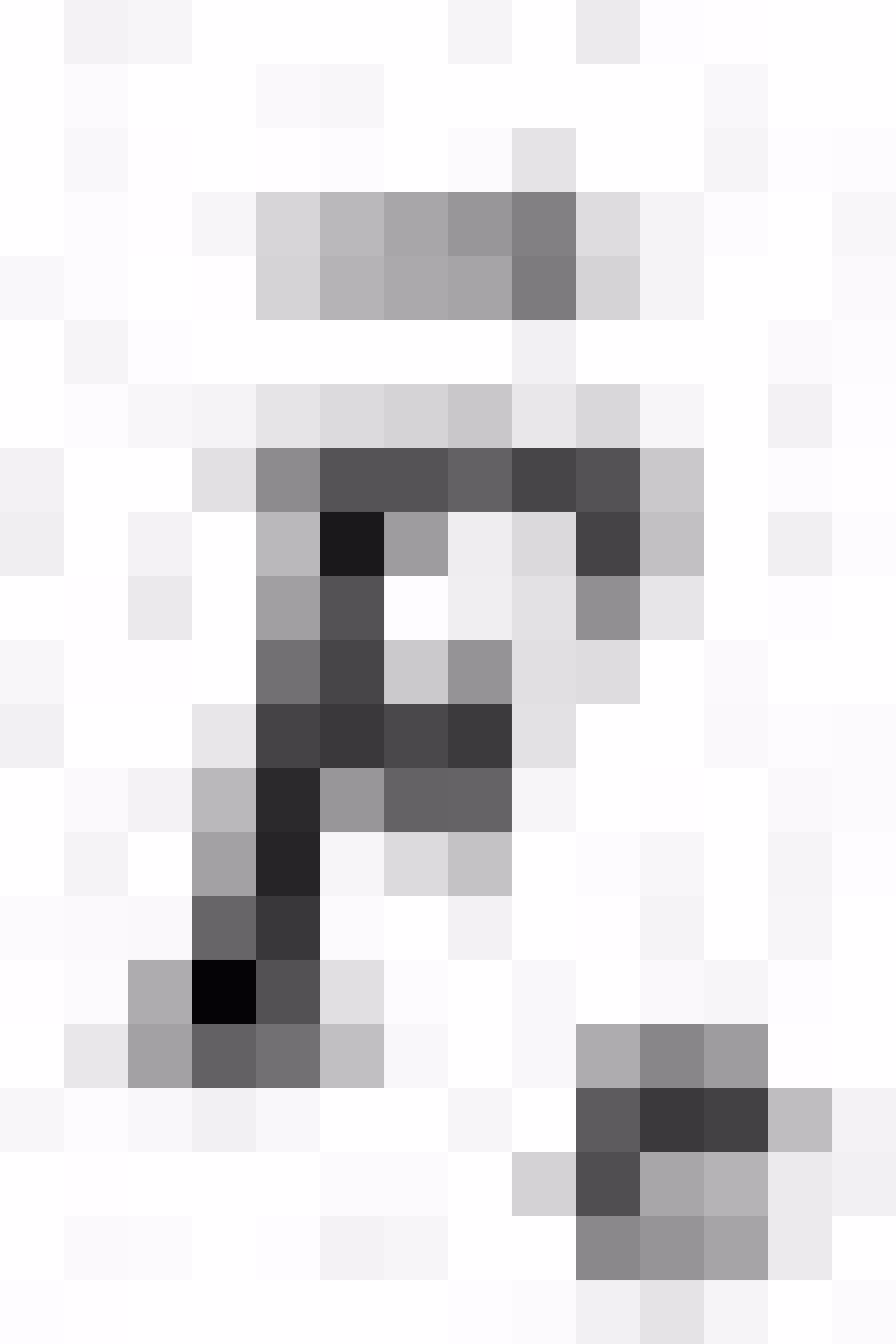

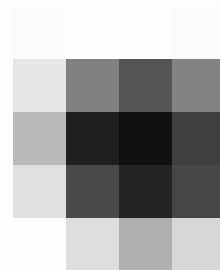
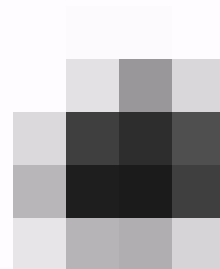
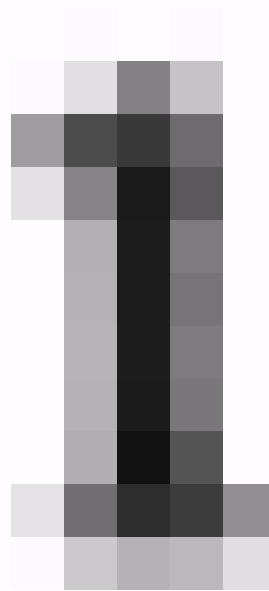
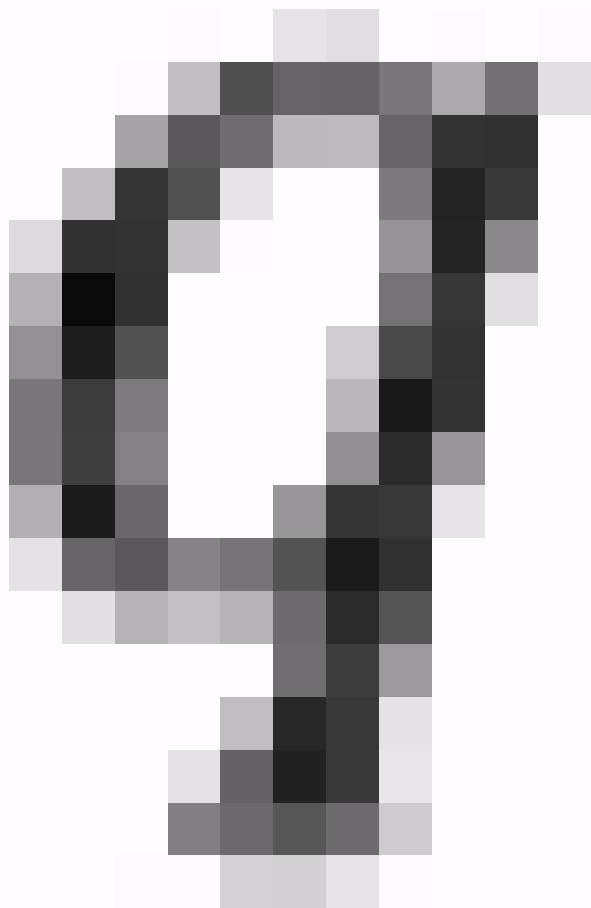

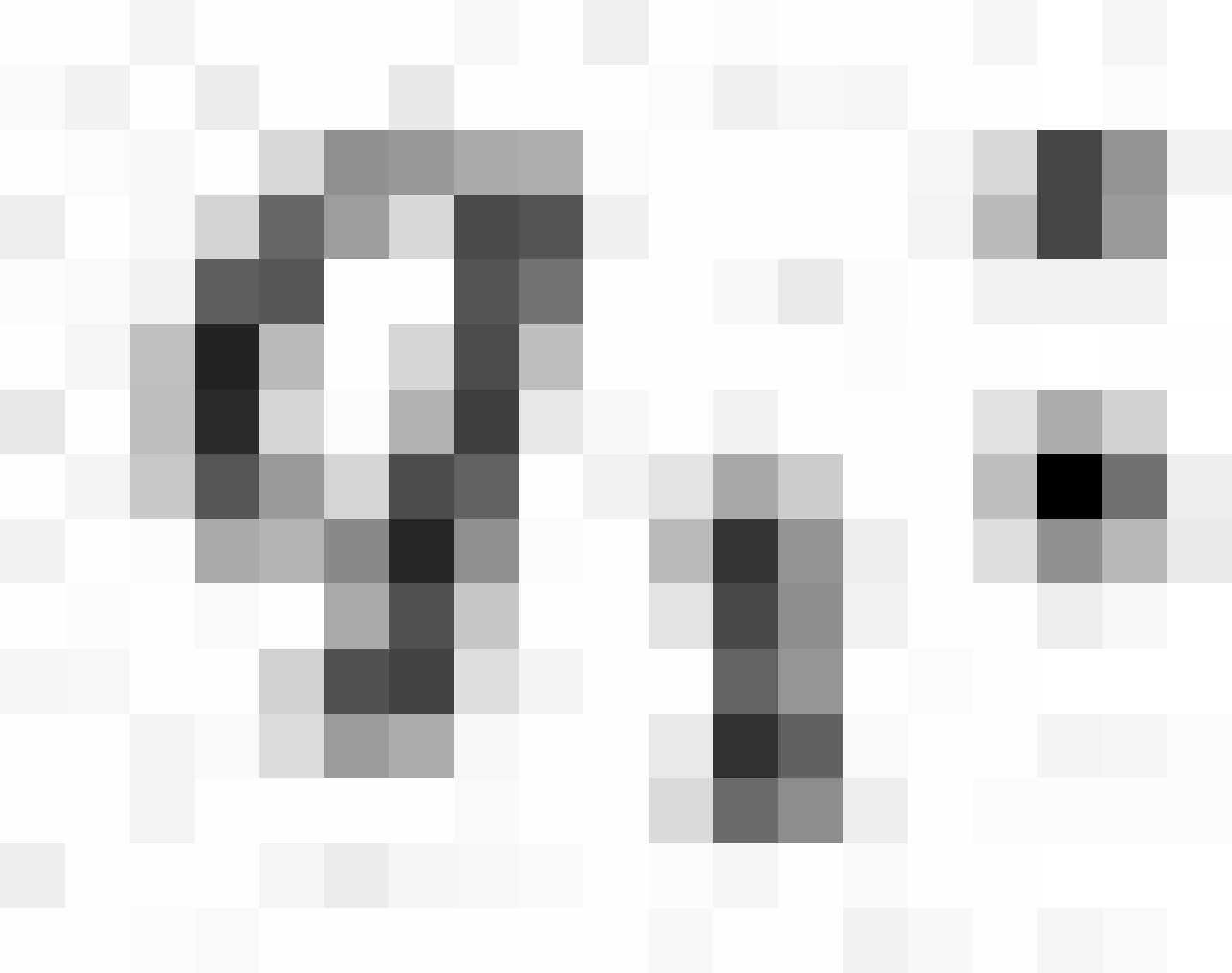

$$\vec{E} = \frac{\vec{F}}{q_1}$$

(35.1)

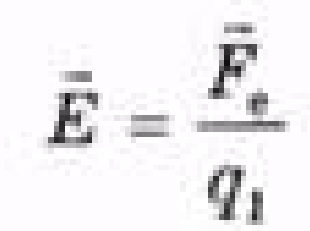

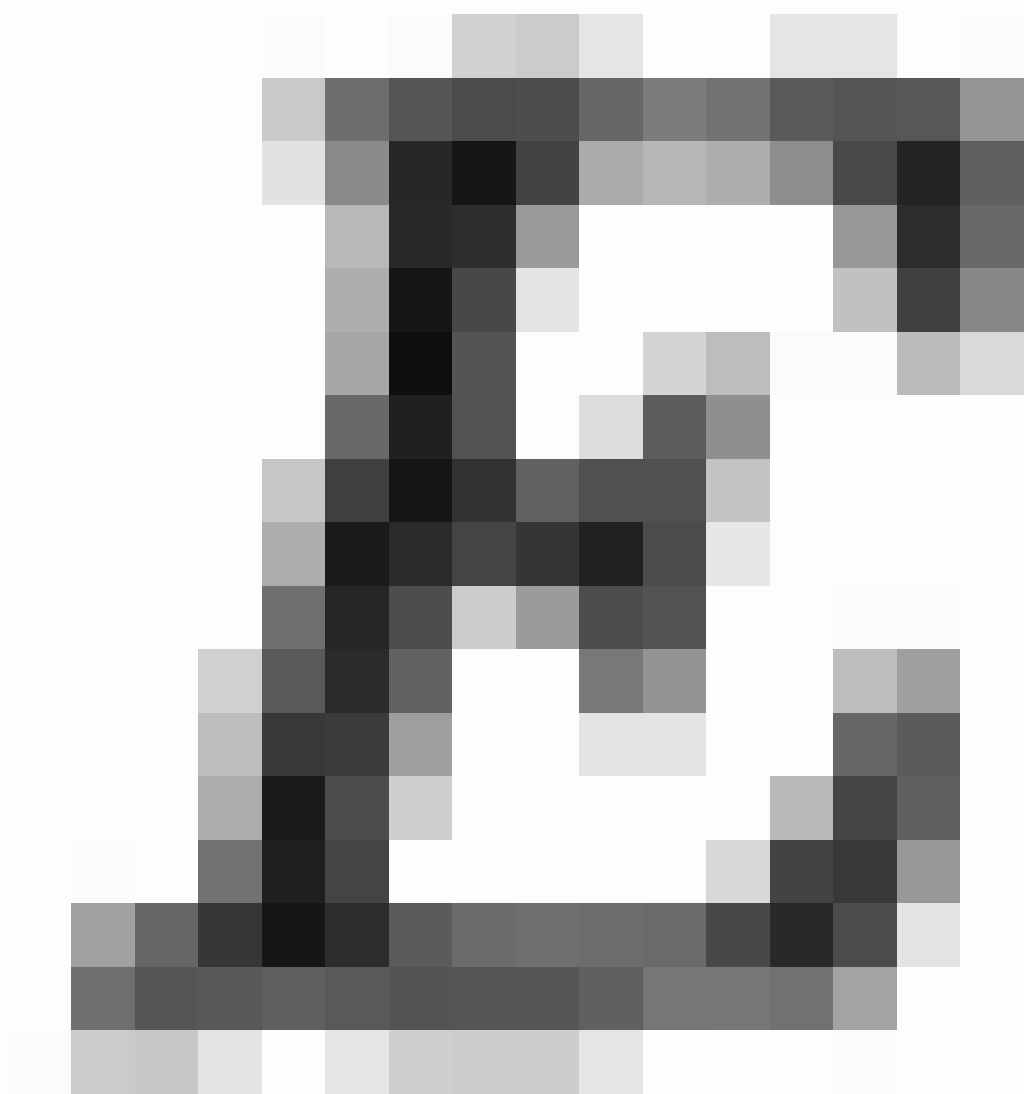
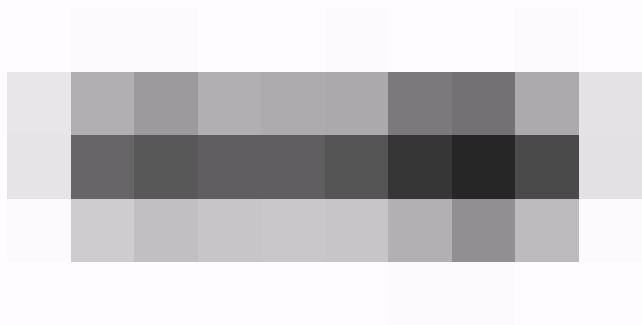

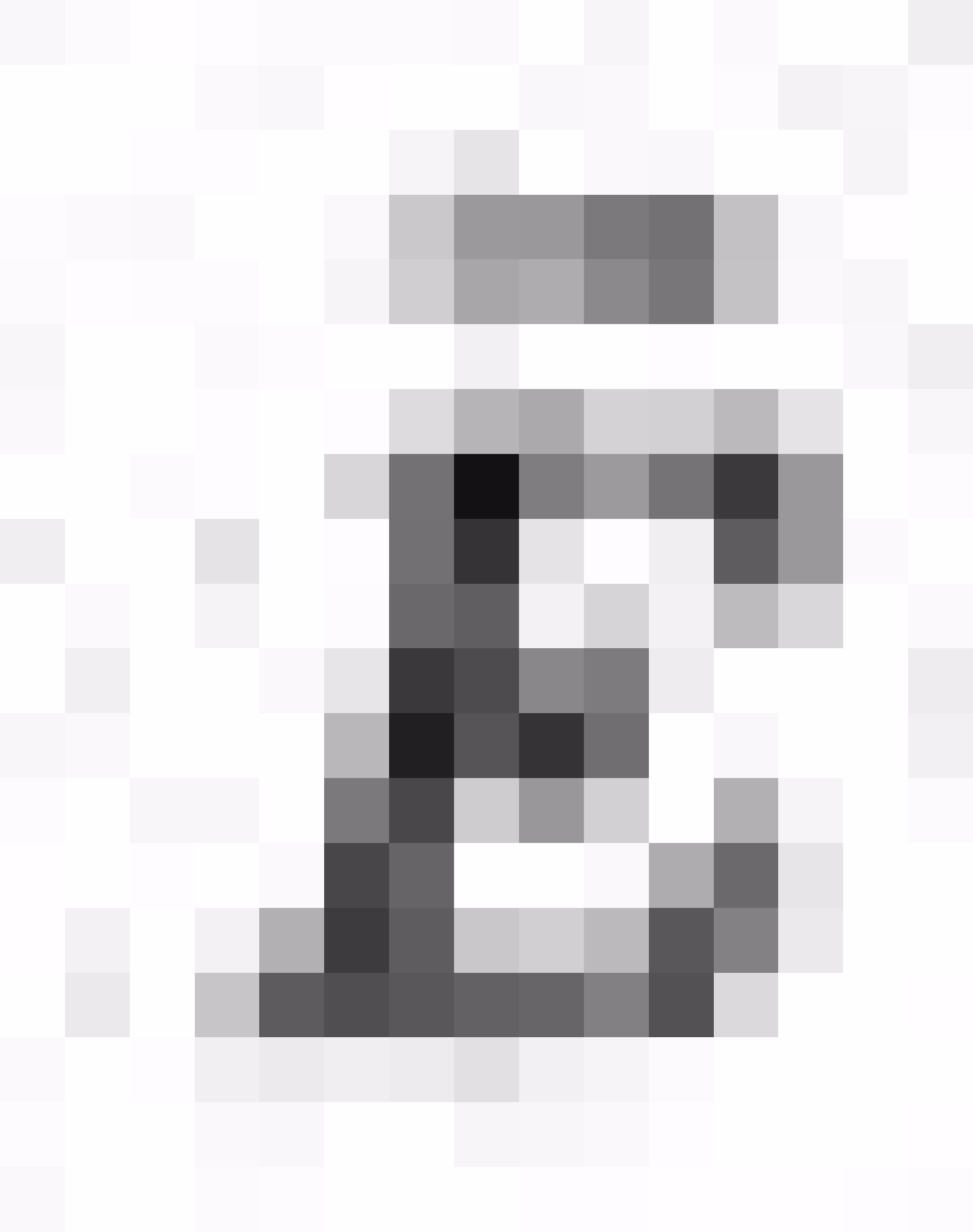

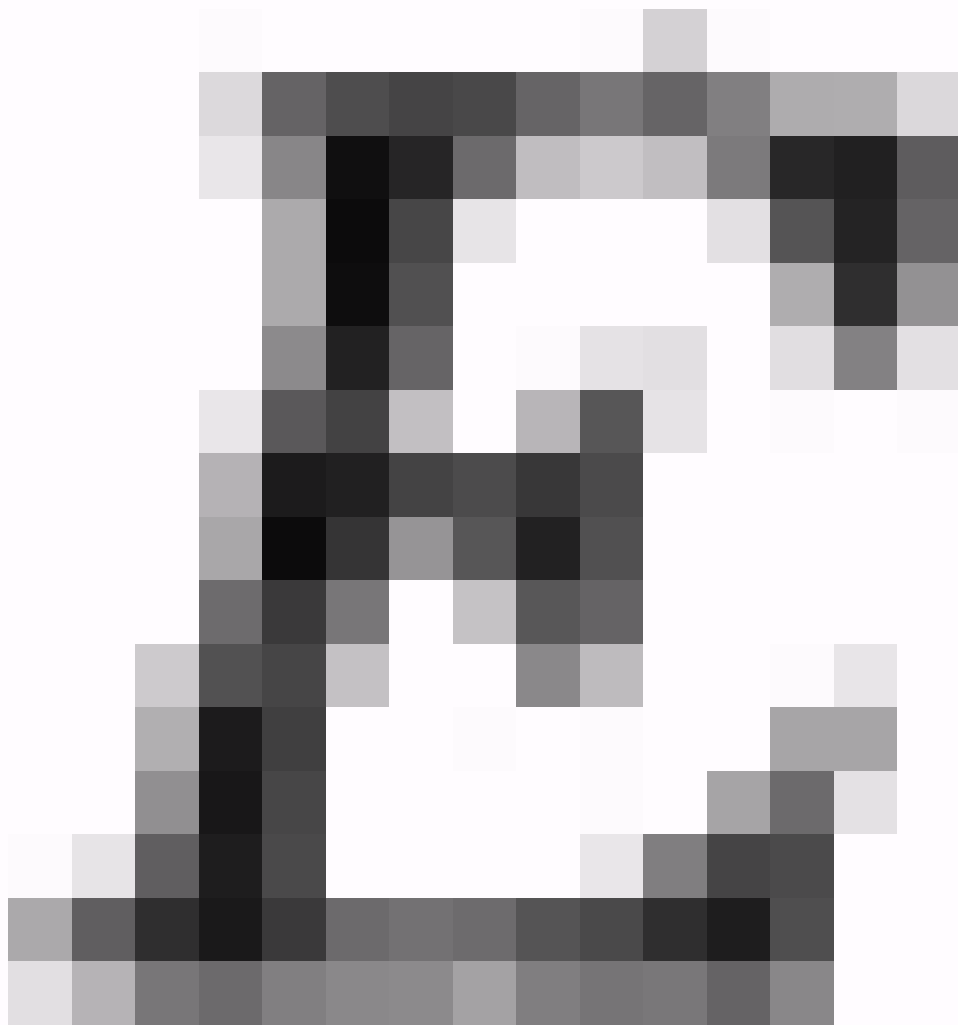
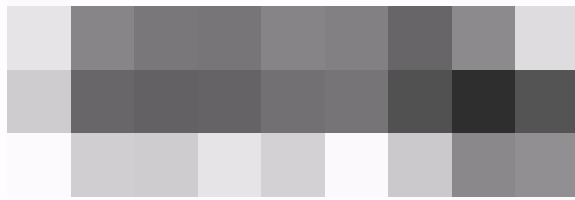

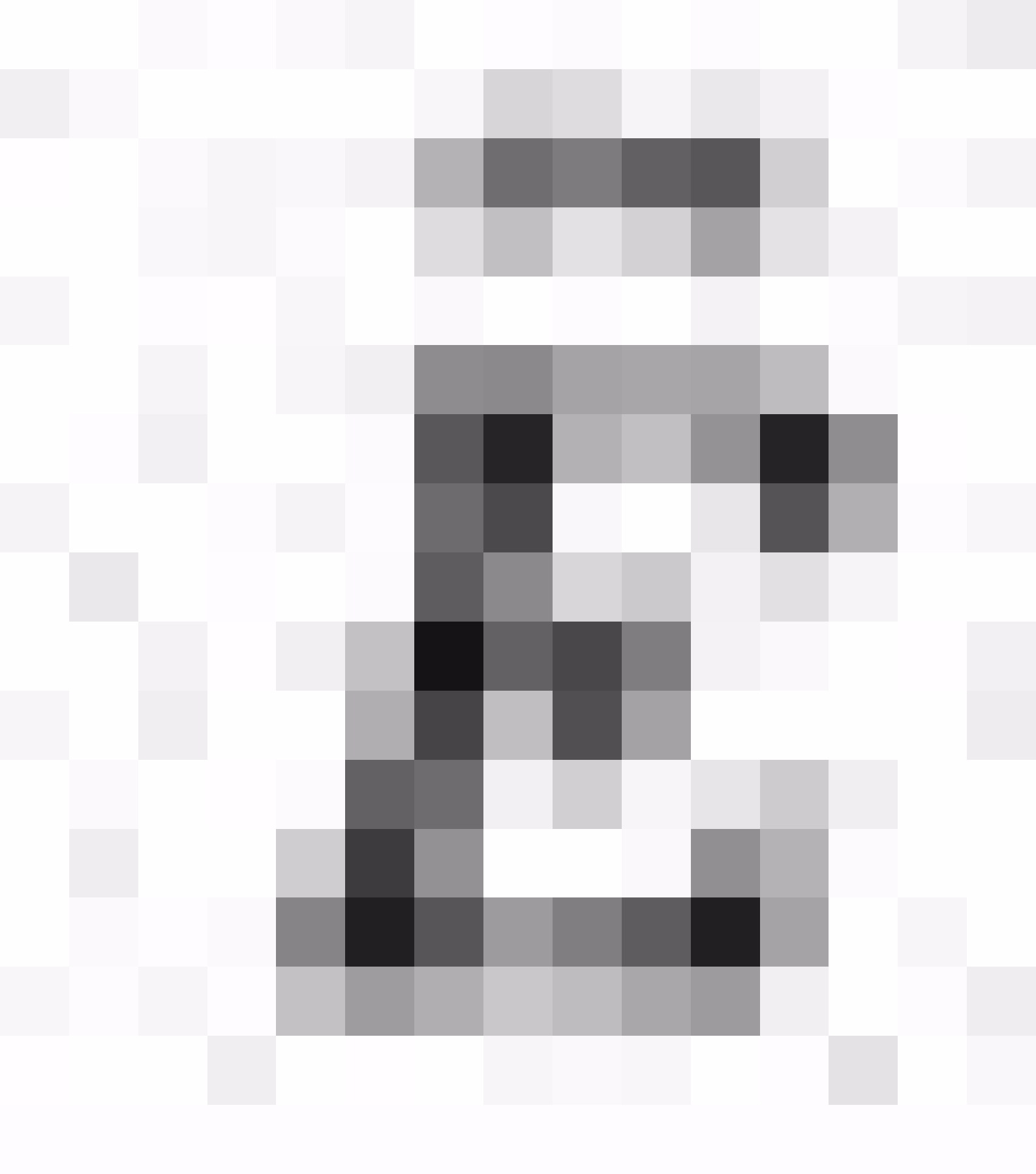

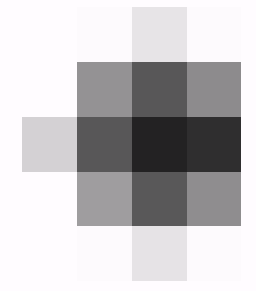
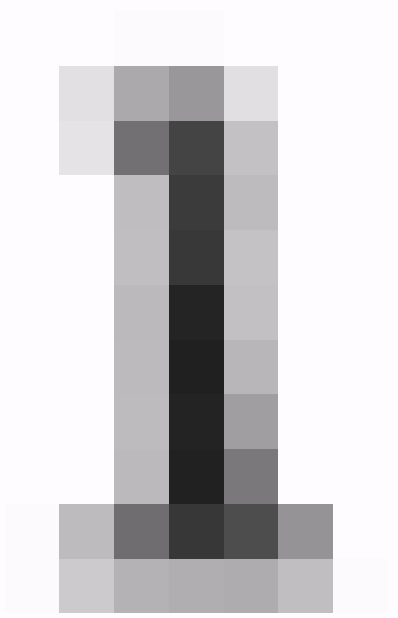
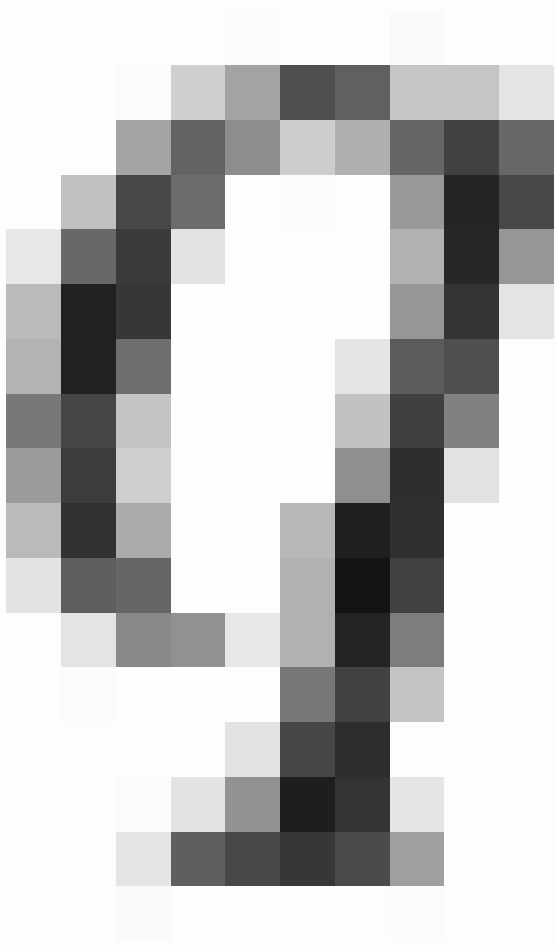

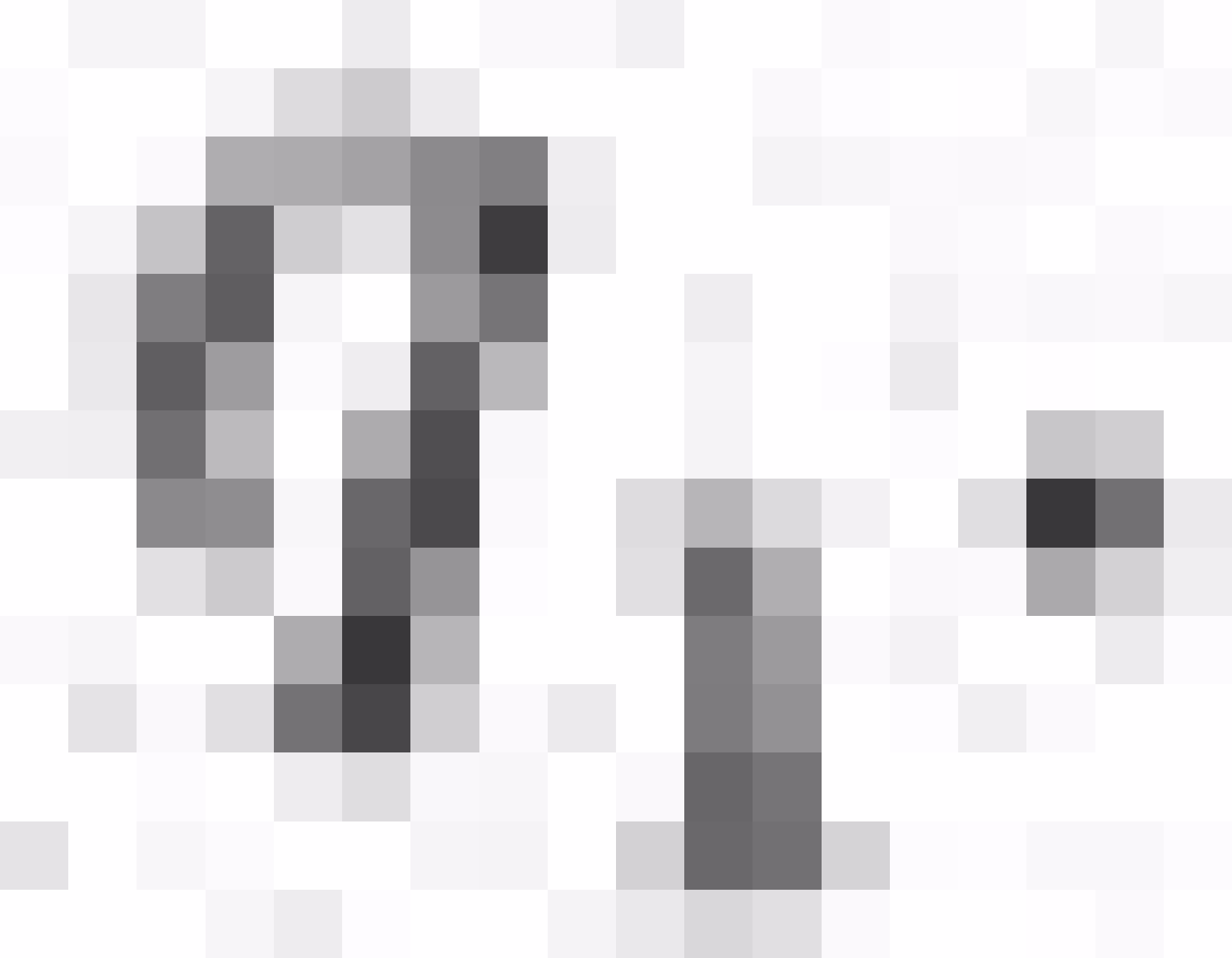

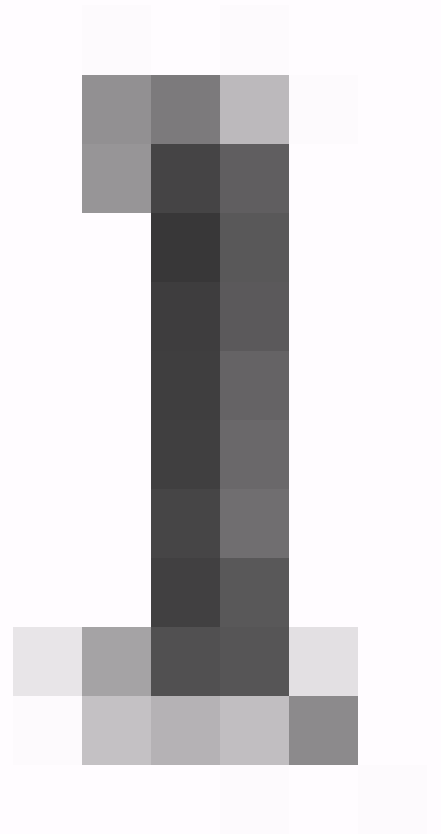
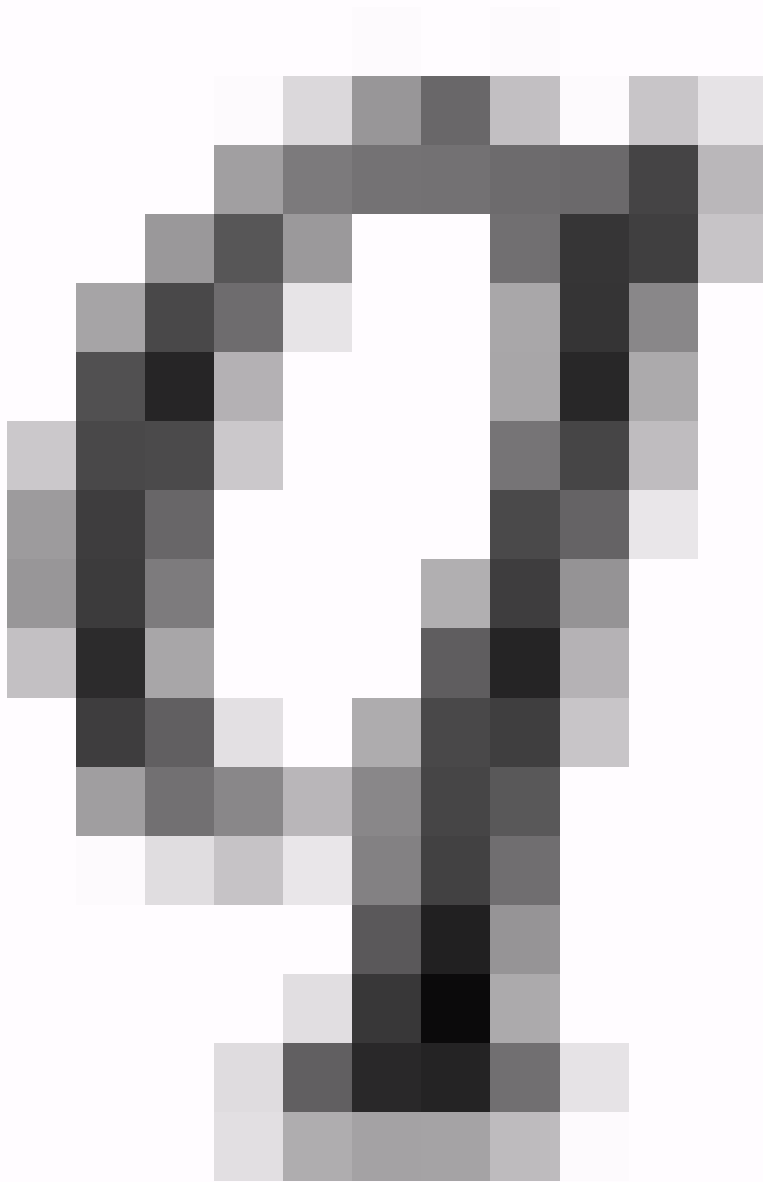

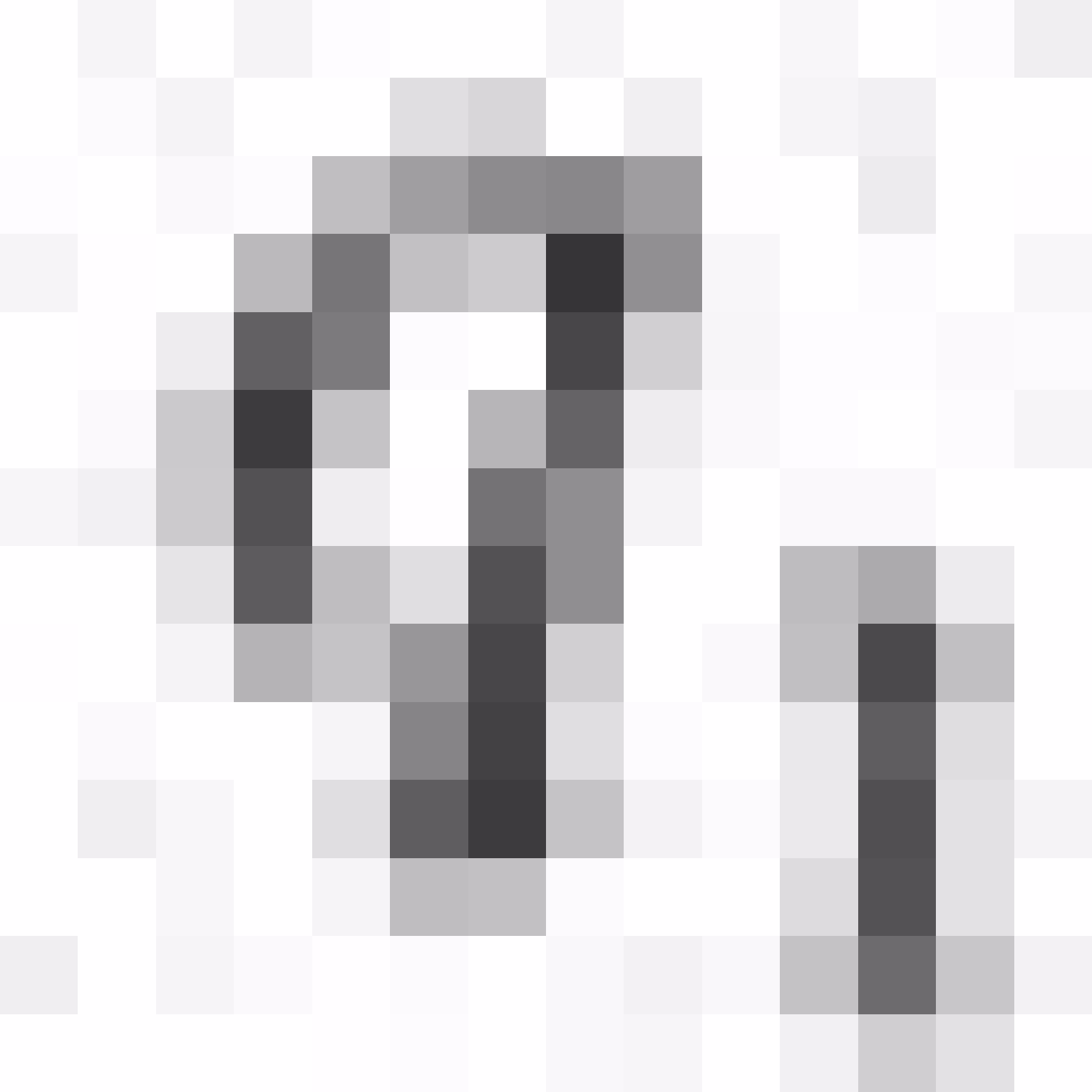

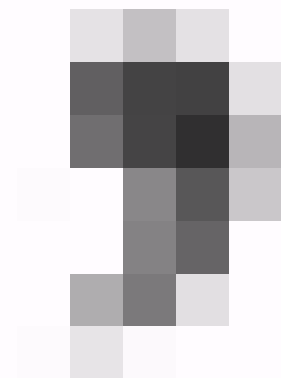
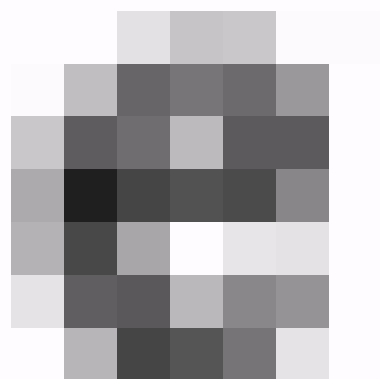

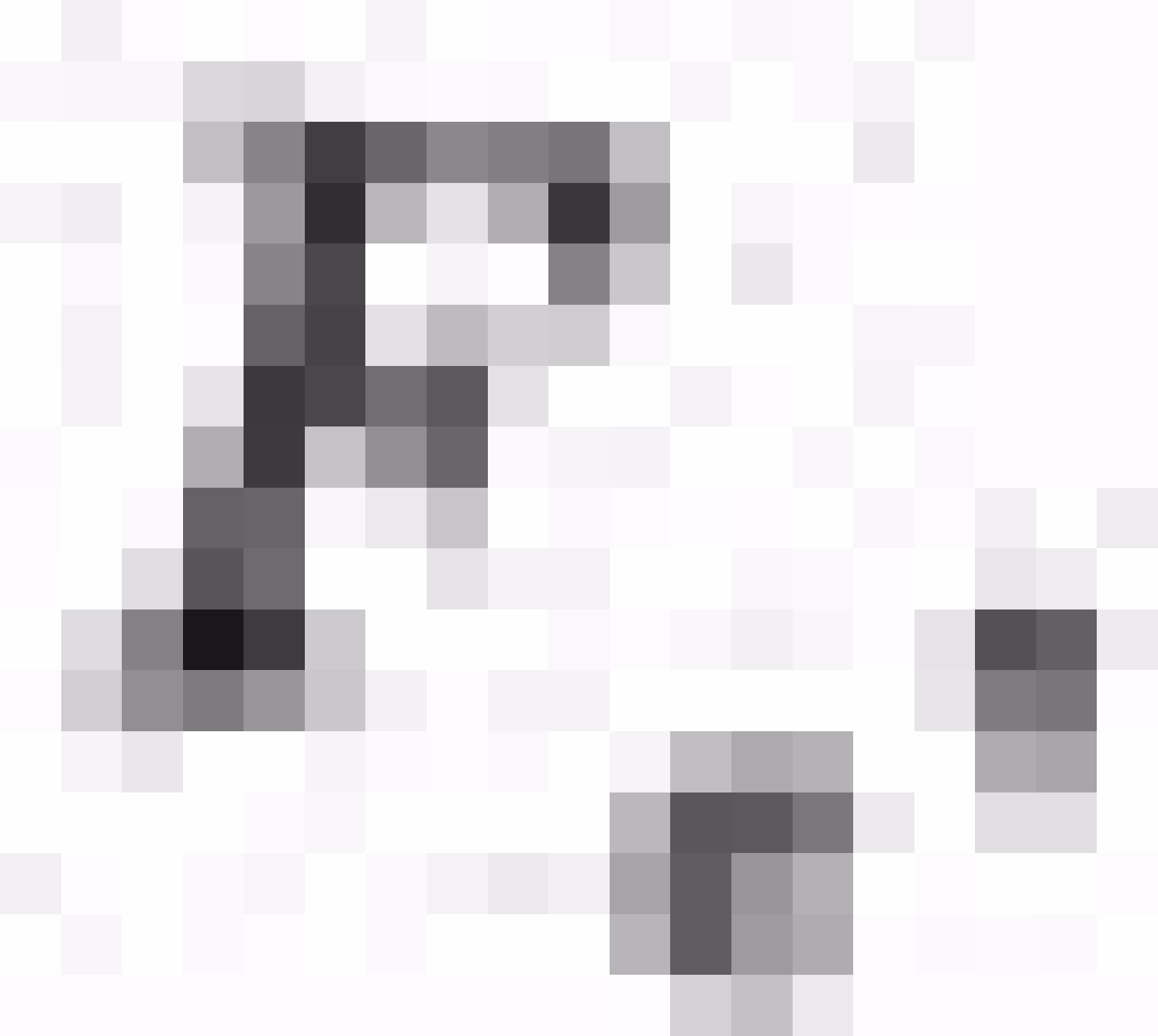

$F = E \cdot Q_1$
 $(35 \cdot 2)$

THE UNIVERSITY OF CHICAGO

PHYSICS DEPARTMENT

$$F_{\theta} = R \frac{Q \cdot Q_1}{r^2} \quad (35.3)$$

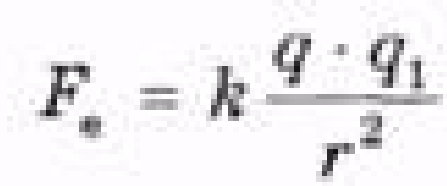

$$E = R \frac{Q}{r^2} \quad (35.4)$$

BRAND

1991



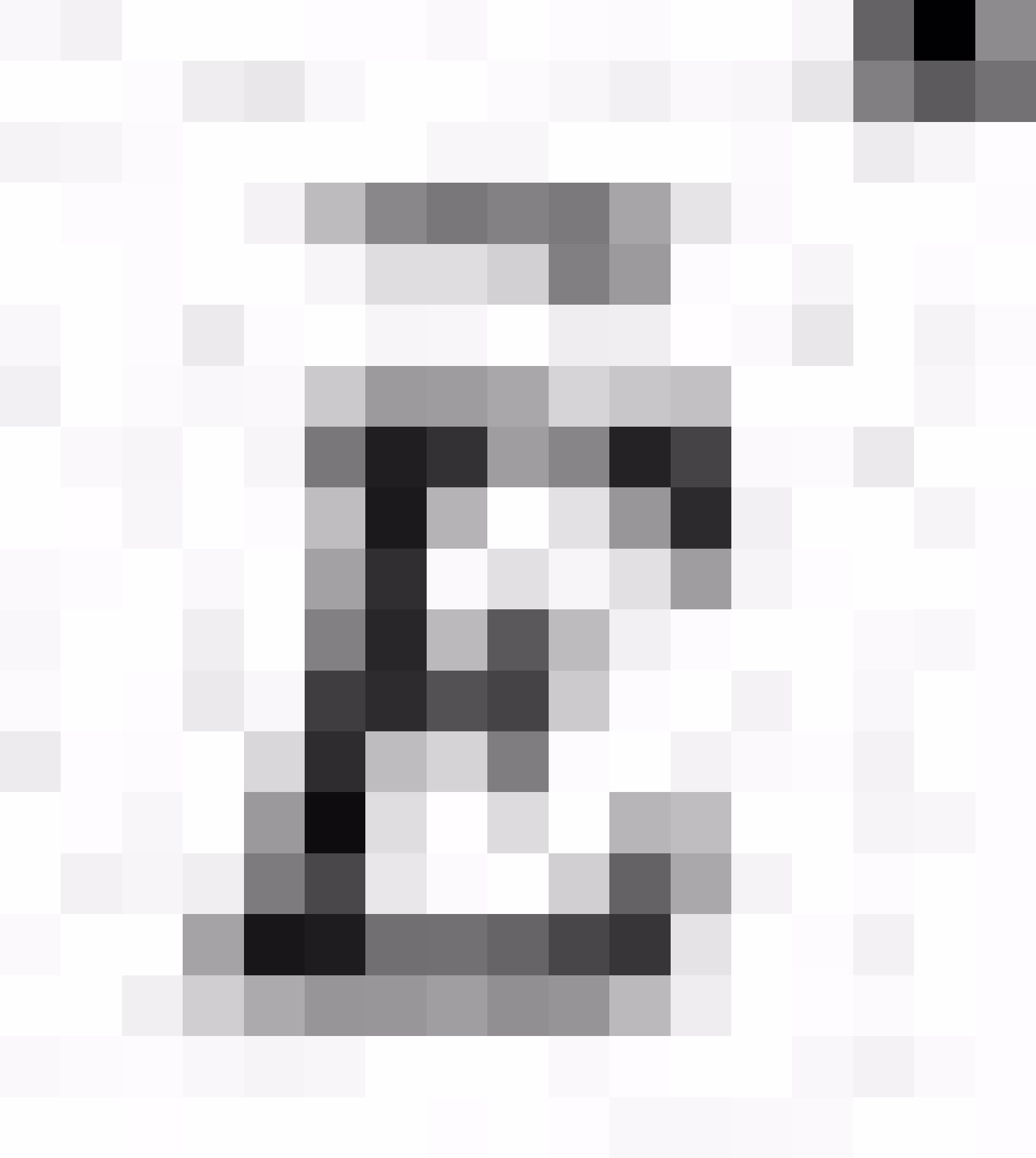

1981

1982

1983



$$E = E_1 + E_2 + \dots + E_n \quad (35.5)$$

THE UNIVERSITY OF CHICAGO
DIVISION OF THE PHYSICAL SCIENCES
DEPARTMENT OF CHEMISTRY
5780 SOUTH CAMPUS DRIVE
CHICAGO, ILLINOIS 60637
TEL: 773-936-3700
WWW.CHEM.UCHICAGO.EDU

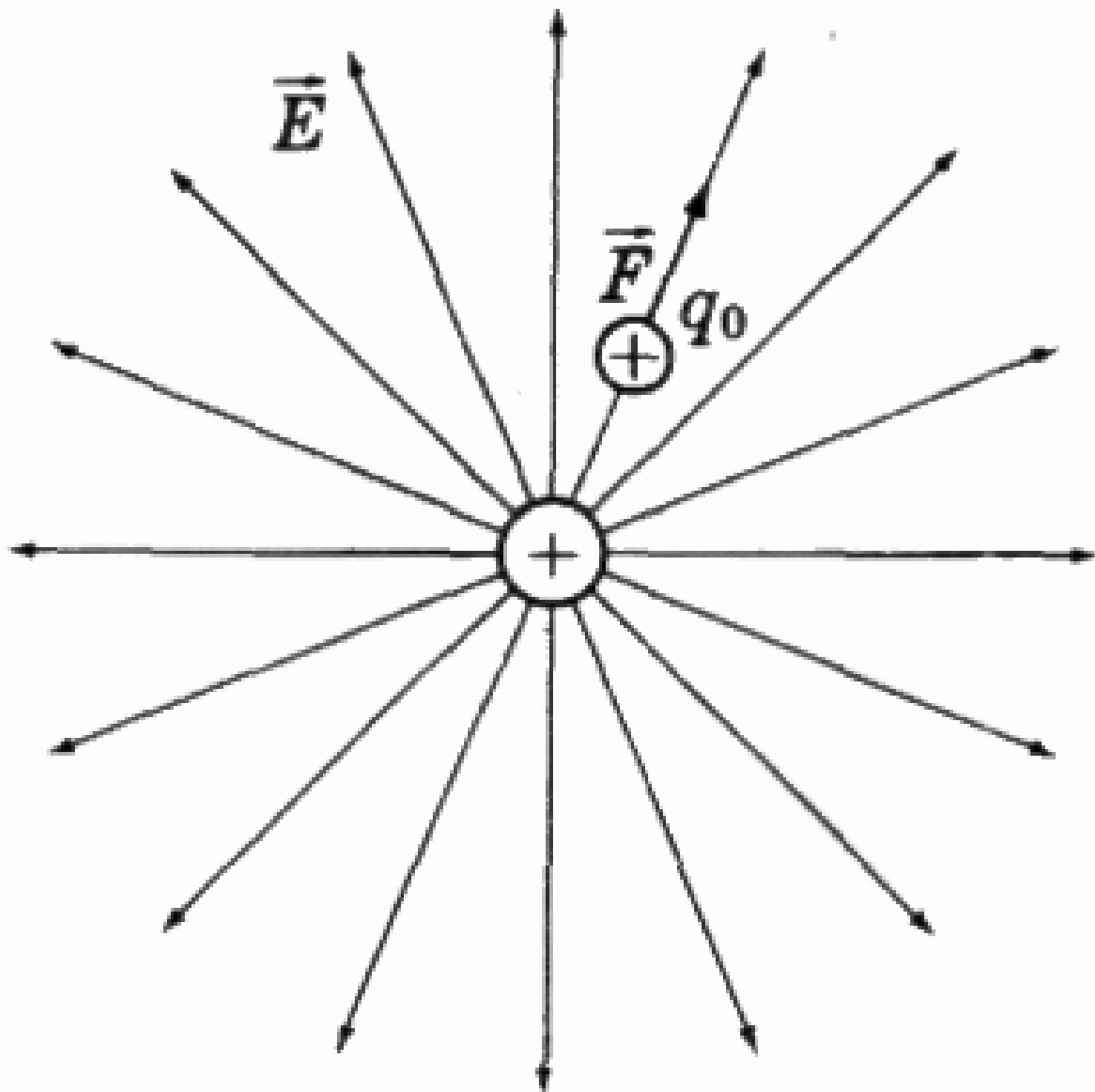

Мал. 2.104

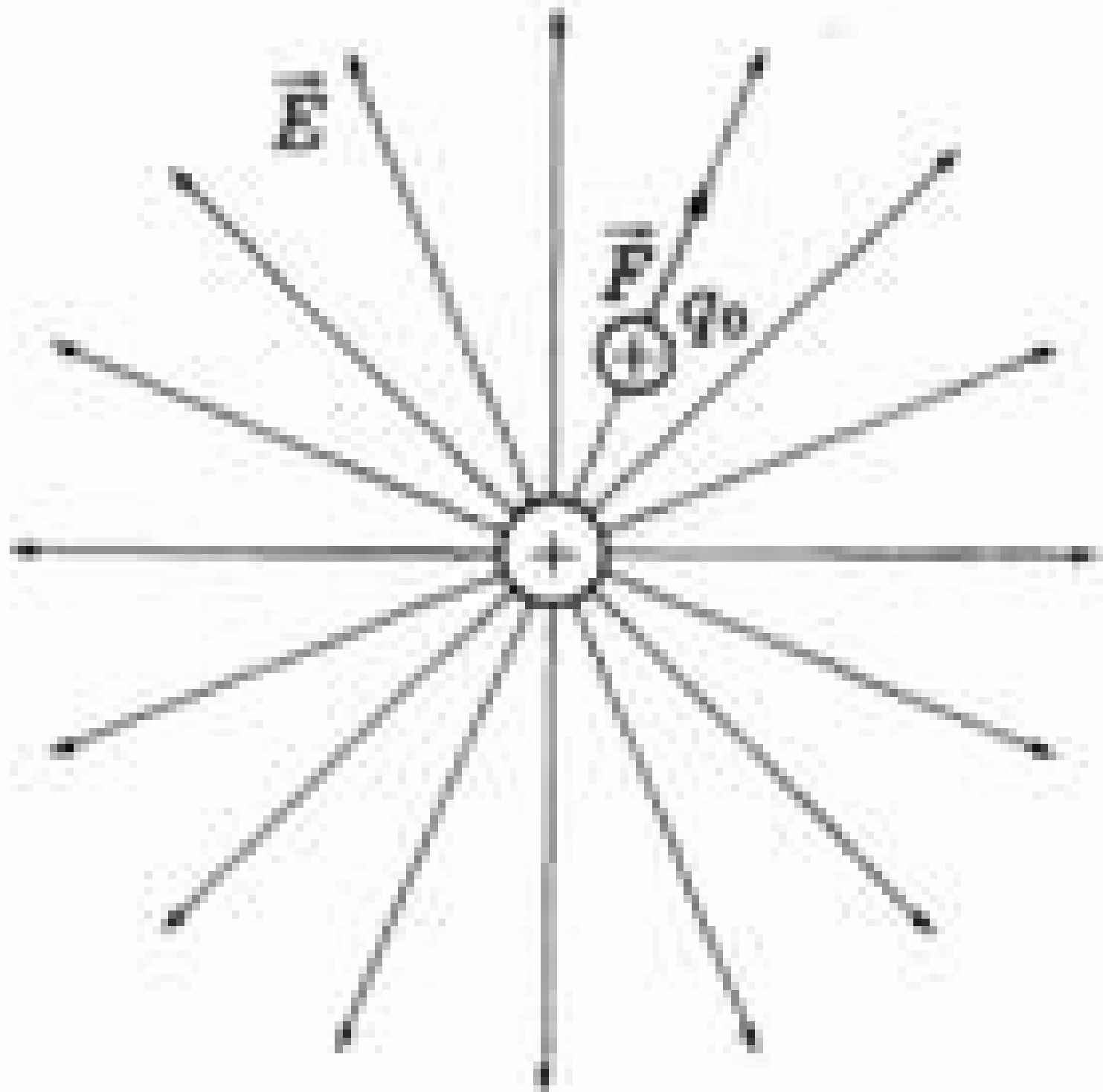

Mat. 2.104

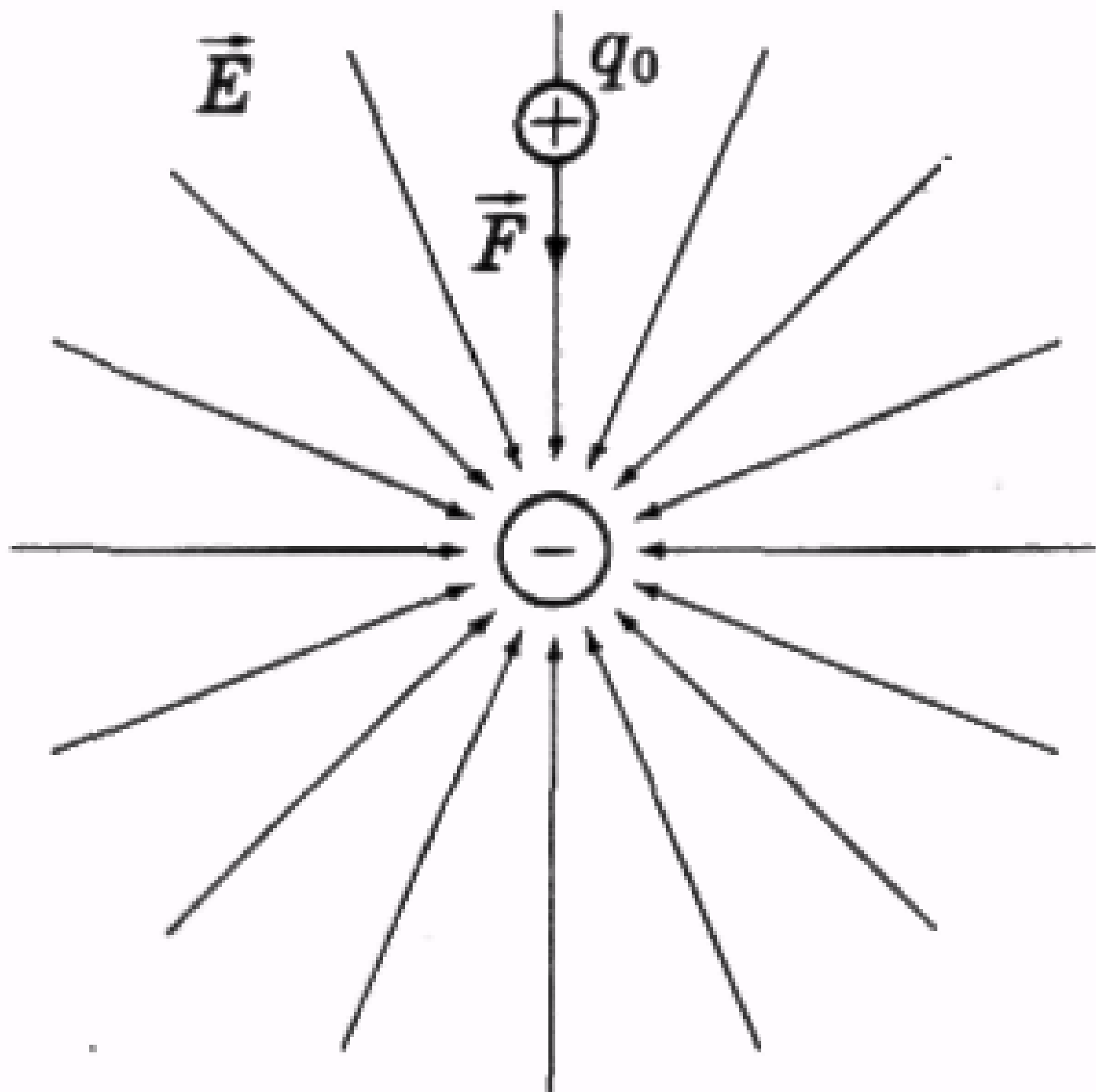

Мал. 2.105

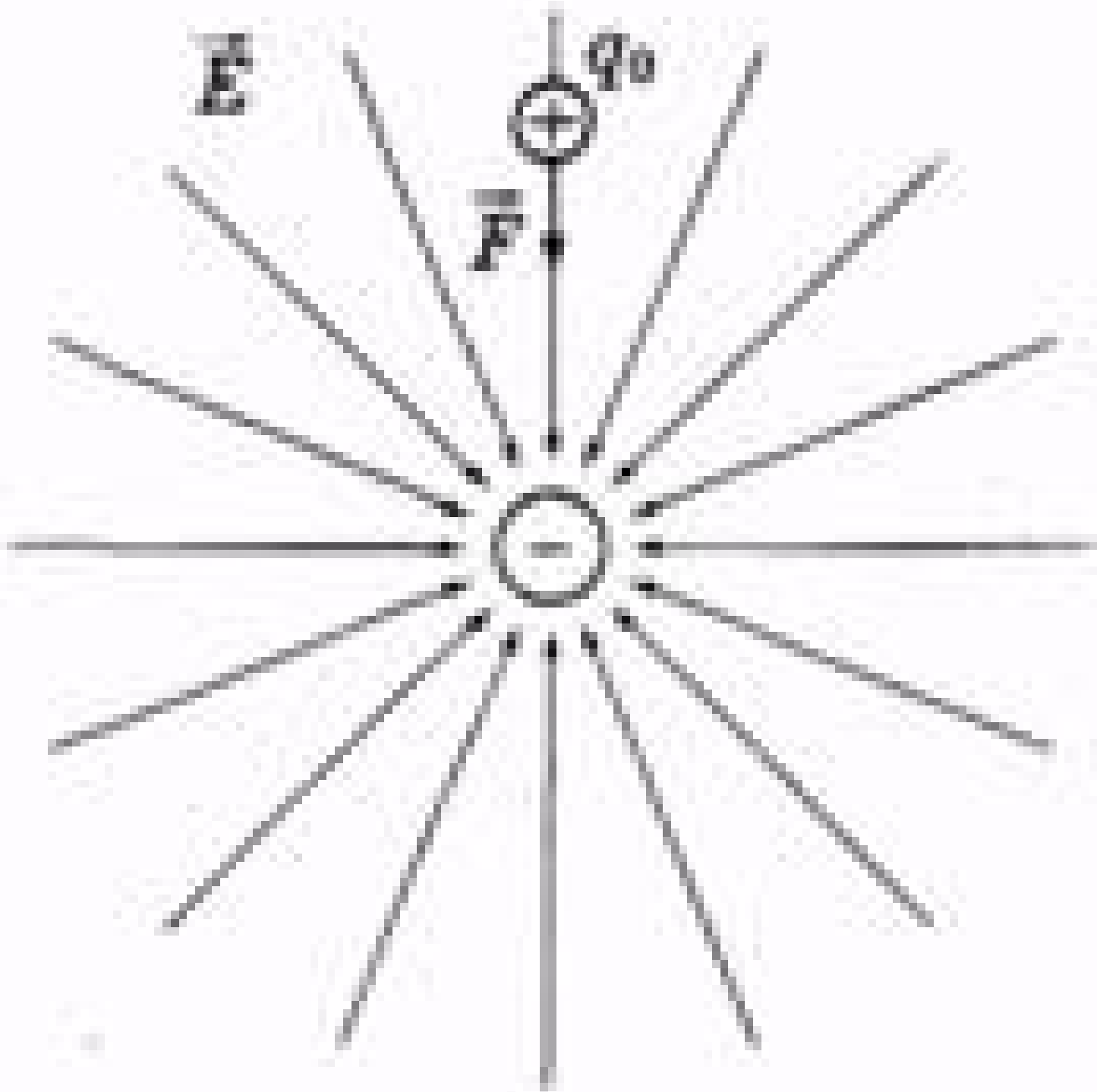

Max 2.105

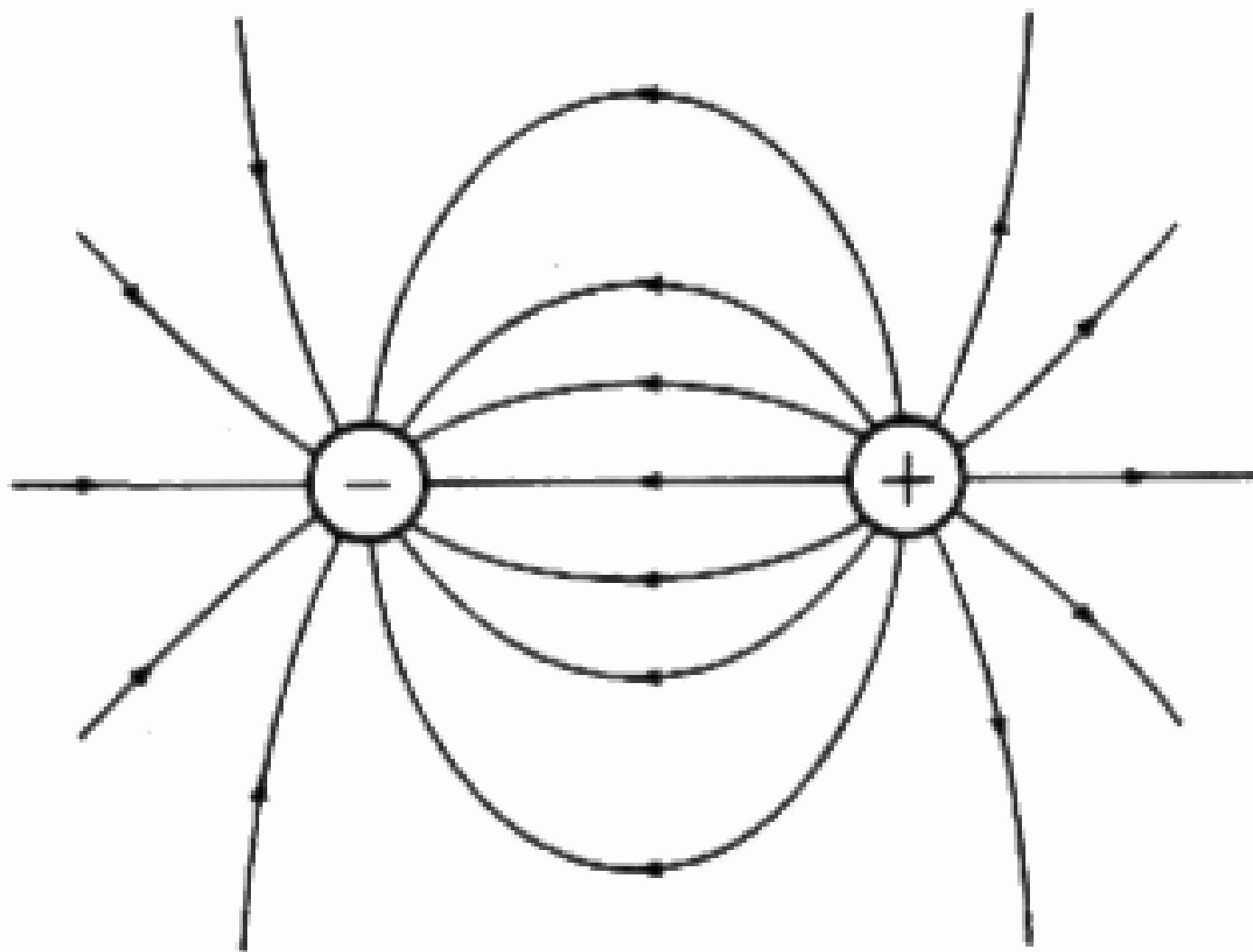

Мал. 2.106

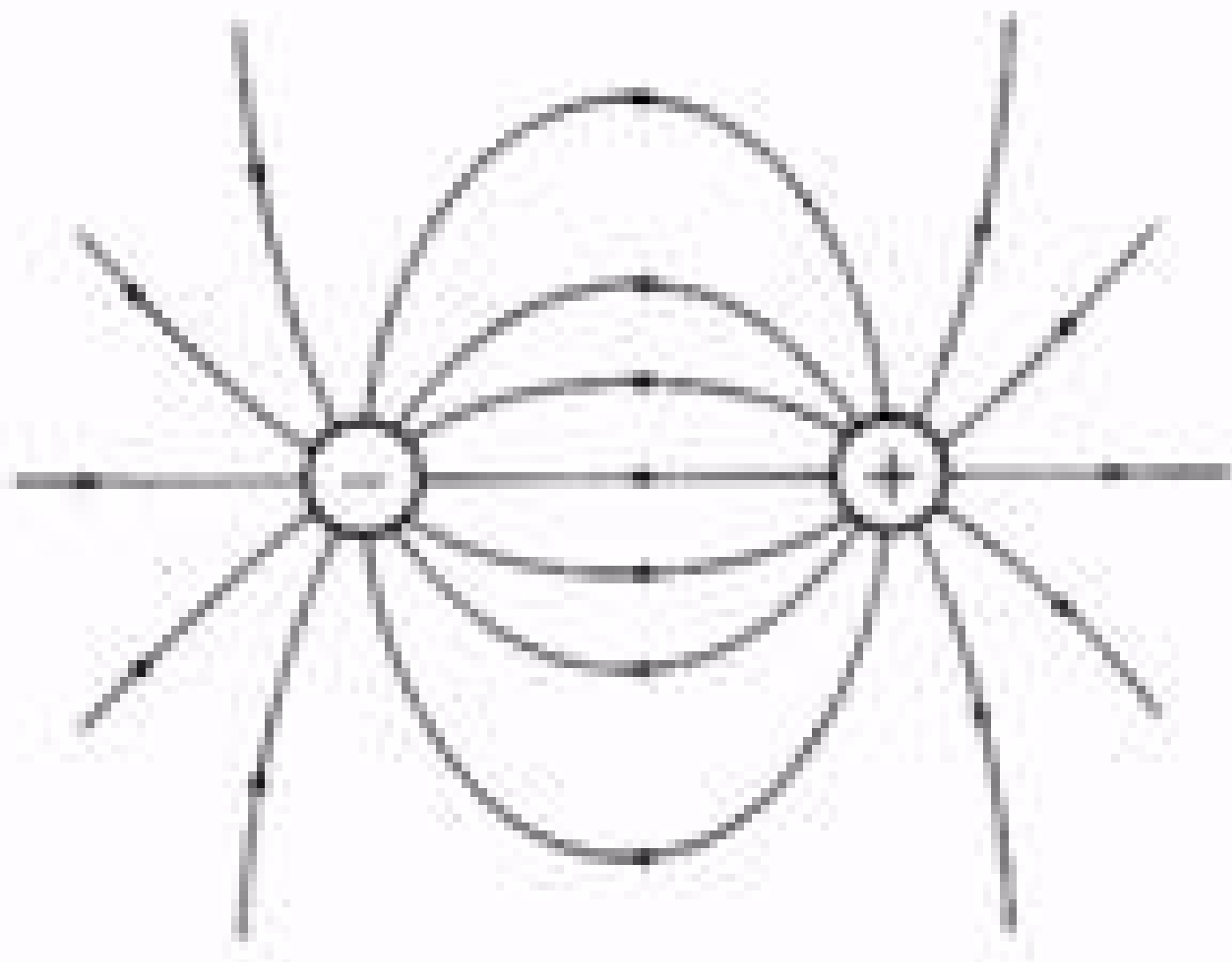

Мал. 3.106

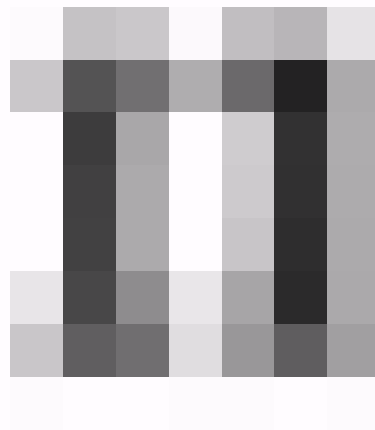
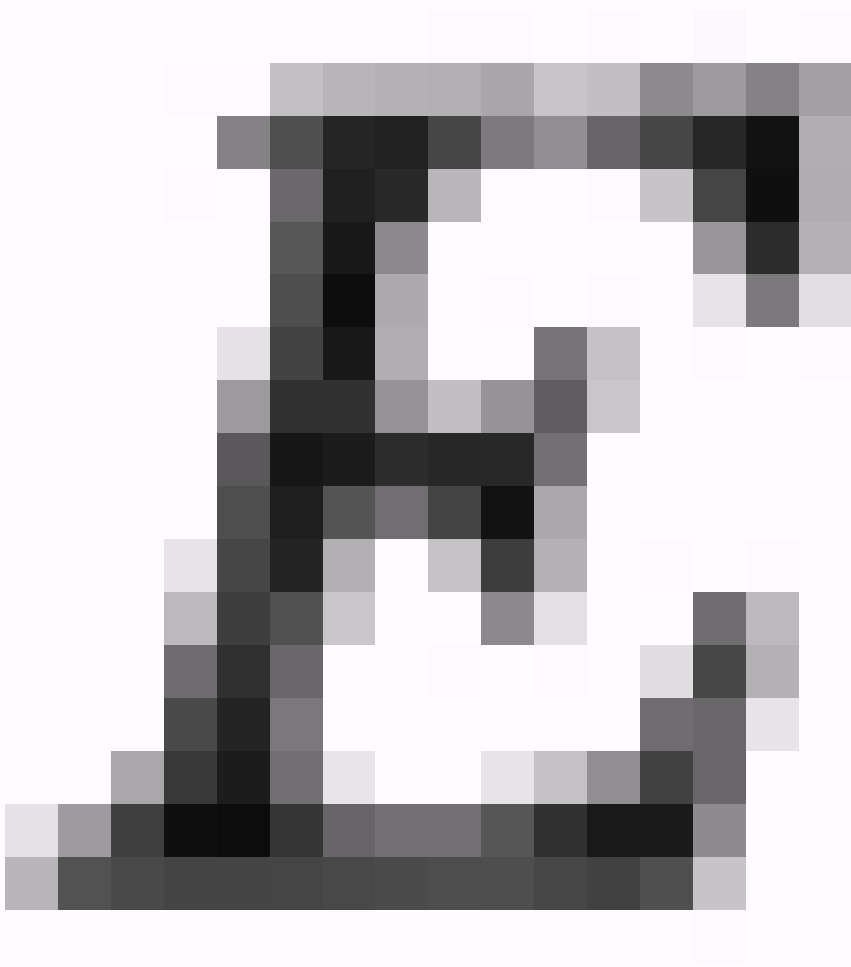

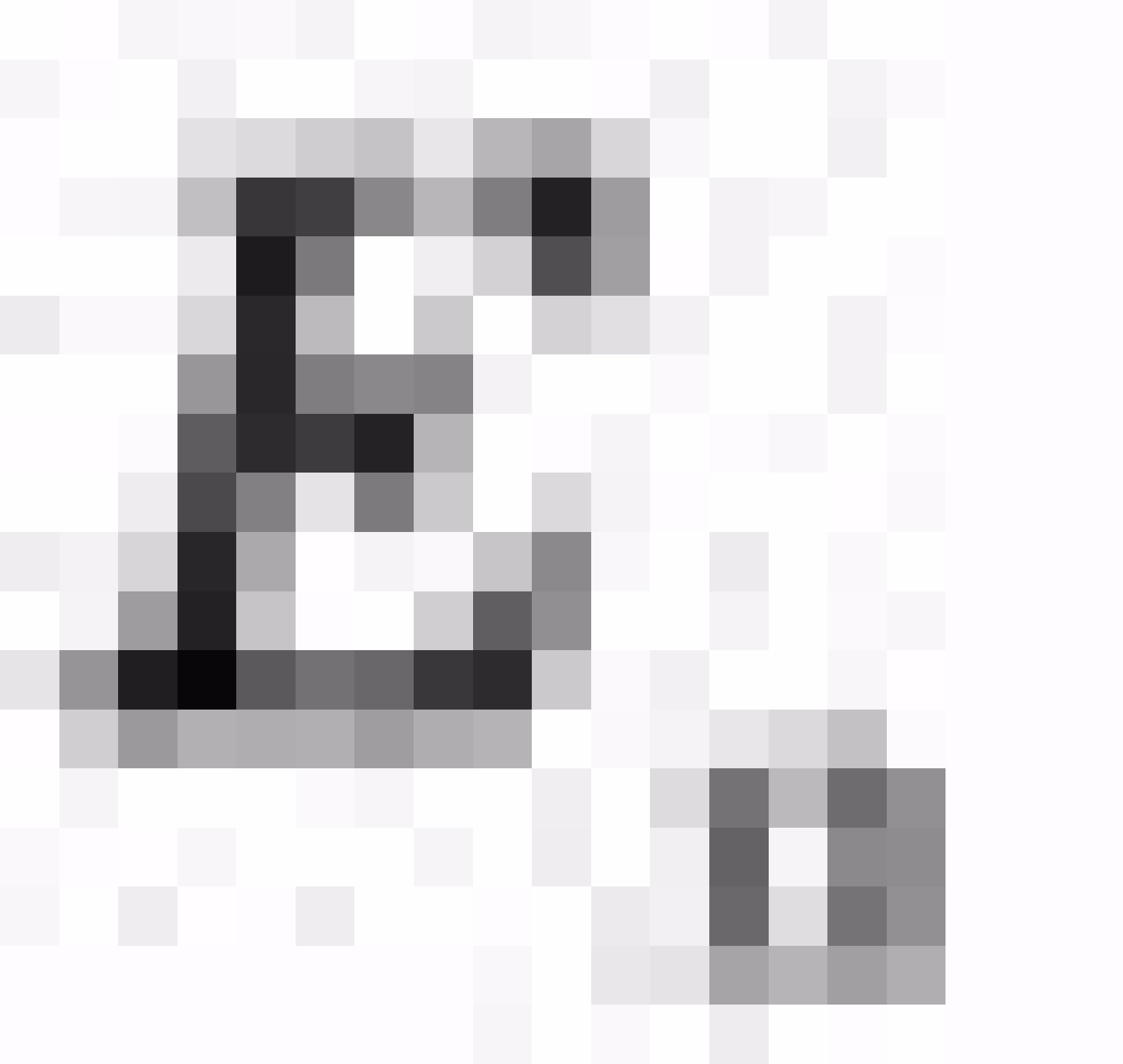

$A = (E, P, Q)$ (E, P, Q)



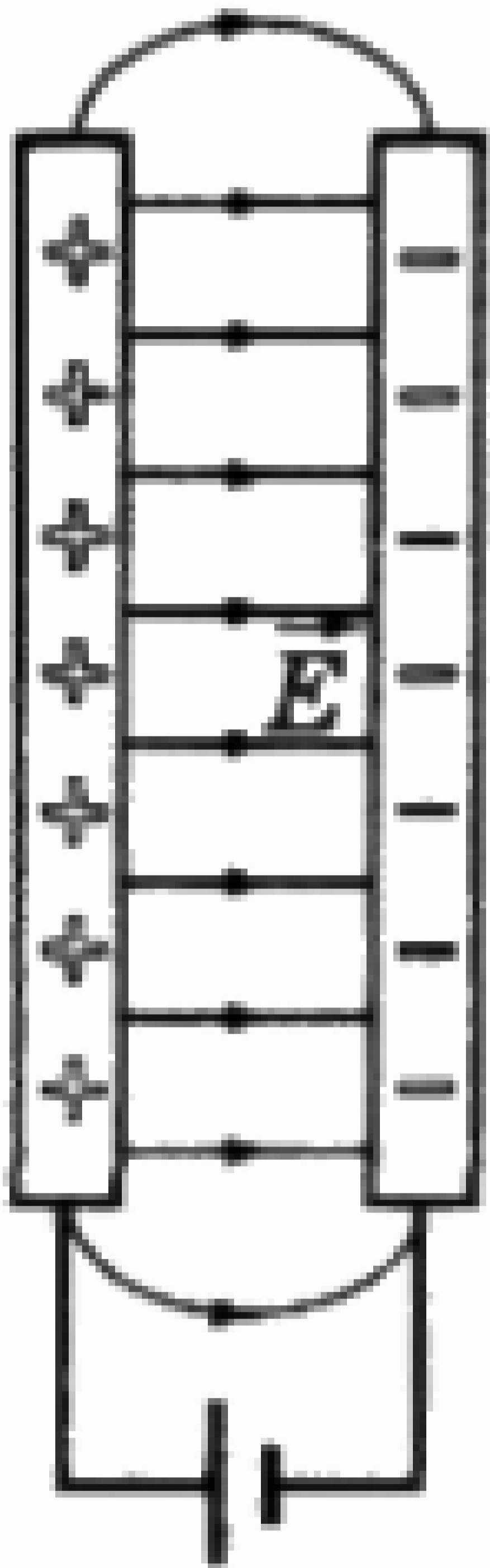

Мал. 2.107

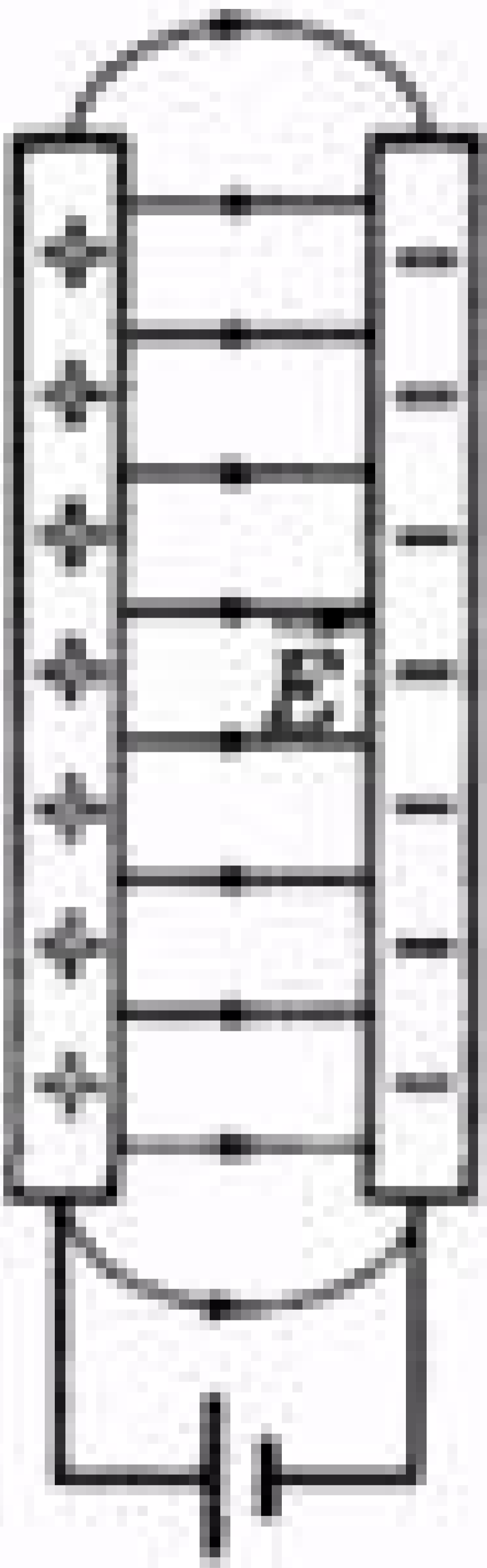

www.2107

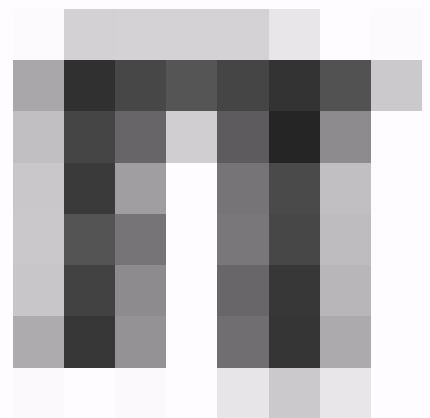
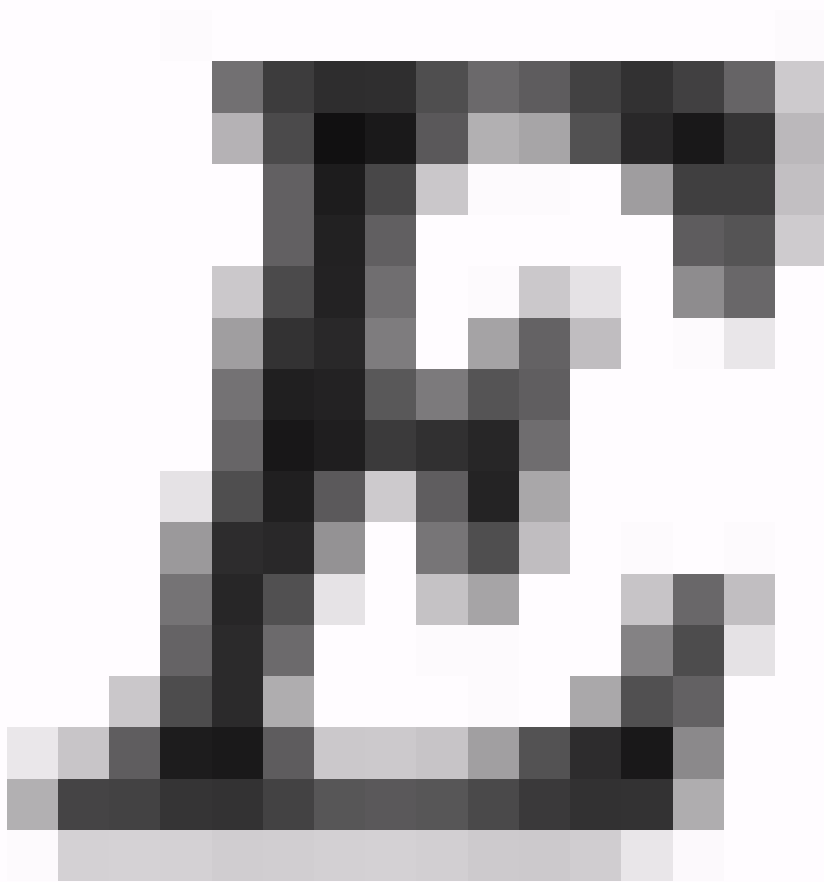



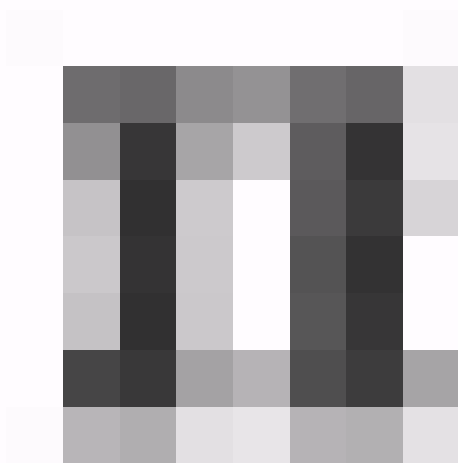

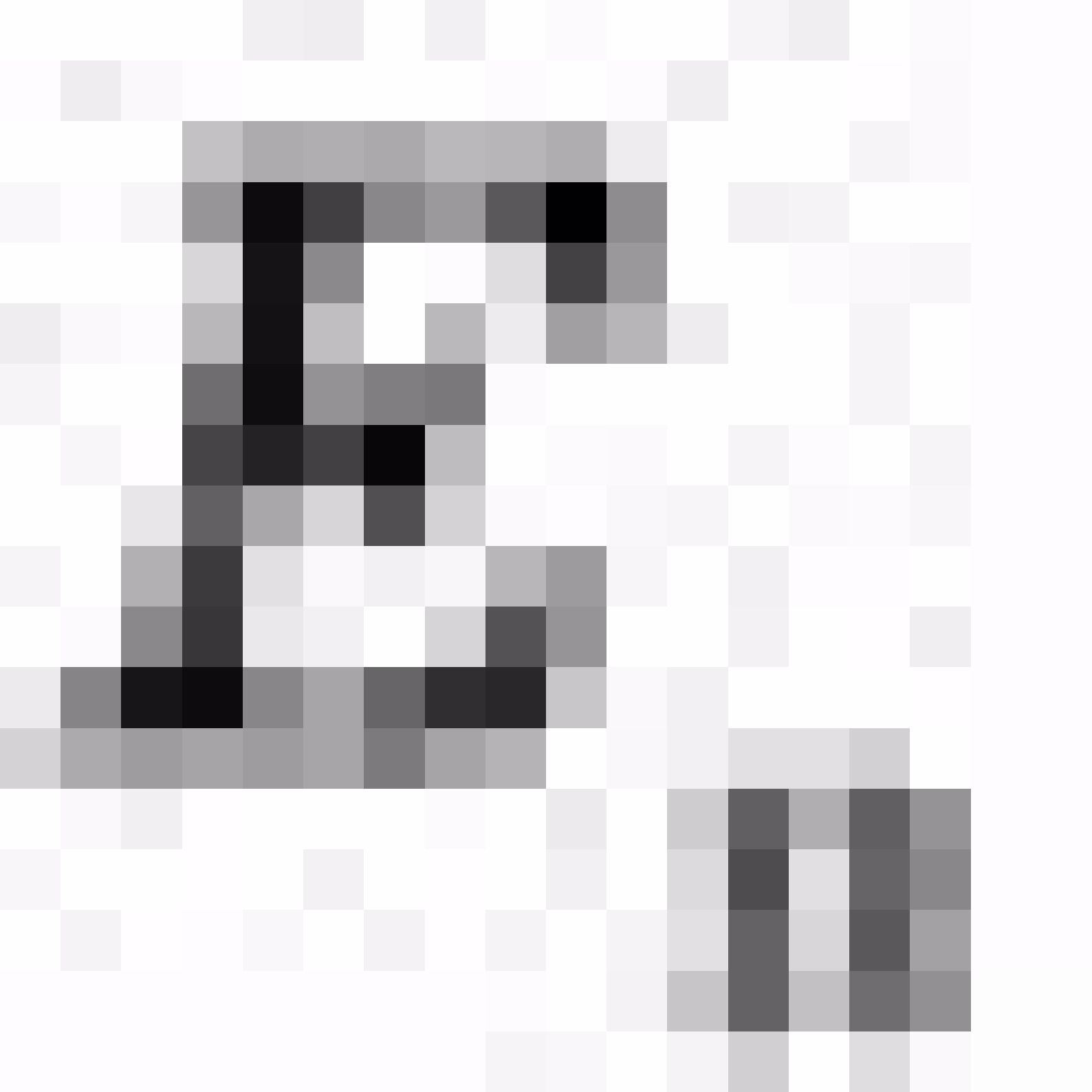

$$\varphi = \frac{E_p}{Q} \quad (35.7)$$

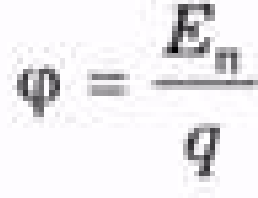

$$A = \begin{pmatrix} \varphi_2 & \varphi_1 \\ \varphi_1 & \varphi_2 \end{pmatrix} = \begin{pmatrix} \varphi_1 & \varphi_1 \\ \varphi_1 & \varphi_2 \end{pmatrix} \quad (35.8)$$

WOLFGANG AMBROSE
WOLFGANG AMBROSE
WOLFGANG AMBROSE

1

1

1

1

1

1

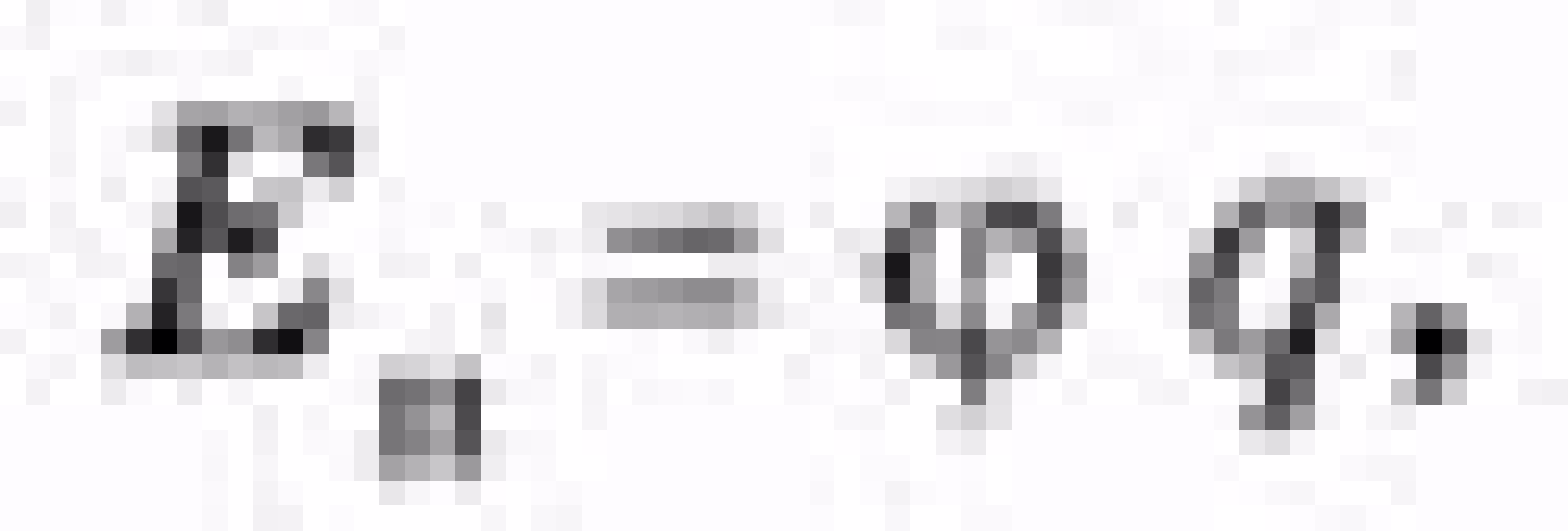

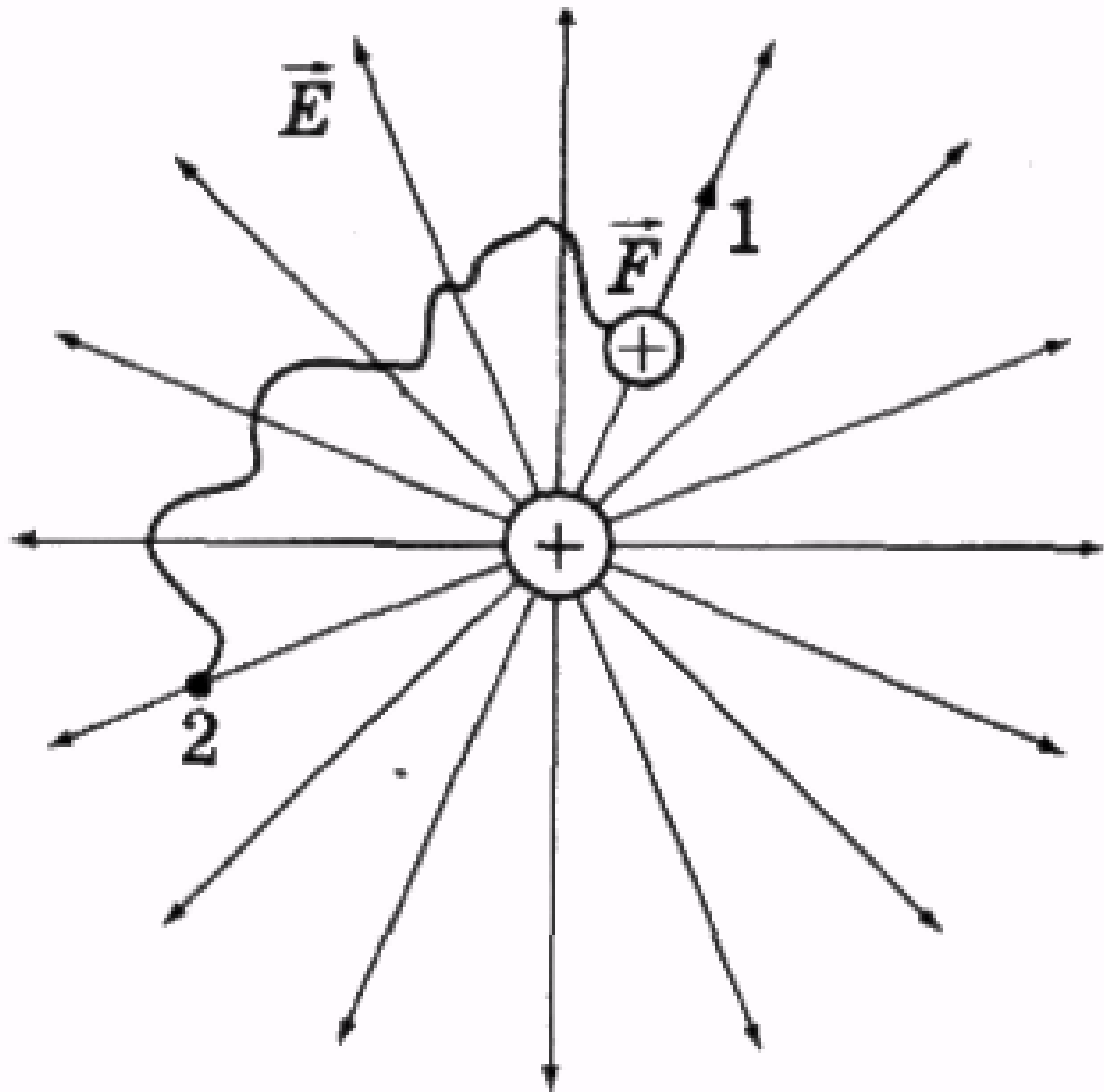

Мал. 2.108

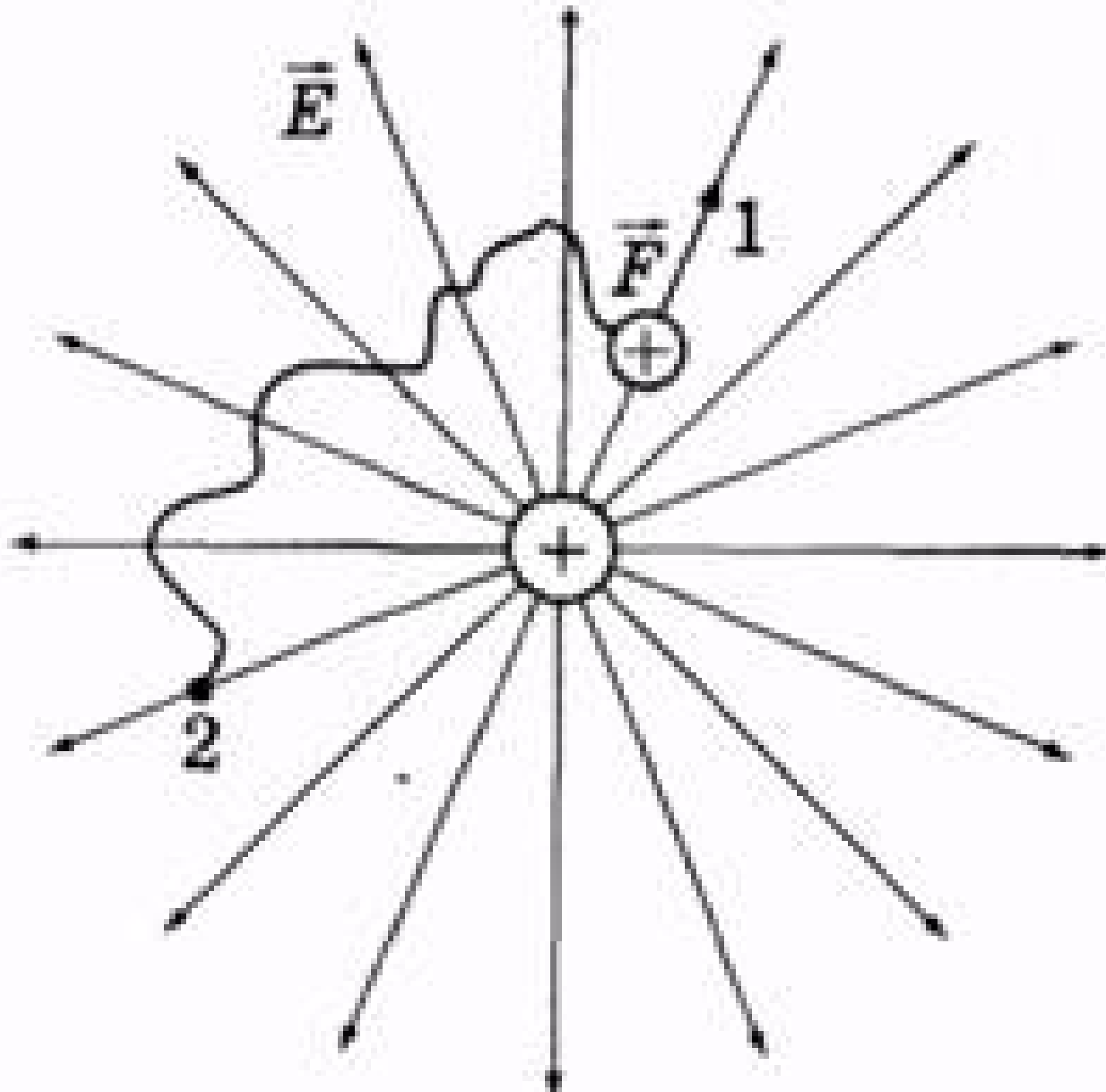

Мал. 2.108

φ

$=$

φ_1

$+$

φ_2

$+$

\dots

\dots

φ_n

(35.9)

THE UNIVERSITY OF CHICAGO

PHYSICS DEPARTMENT

$$\varphi \equiv \frac{RQ}{r}$$

(35.10)

1992

1993

V

$=$

A

q

(35.11)



(35.12)

$$v = \varphi_1 - \varphi_2$$

(35.12)

1990-1991

1991-1992

$$1B = \frac{1DX}{1KN} \cdot$$

13 =

13 =

13 =

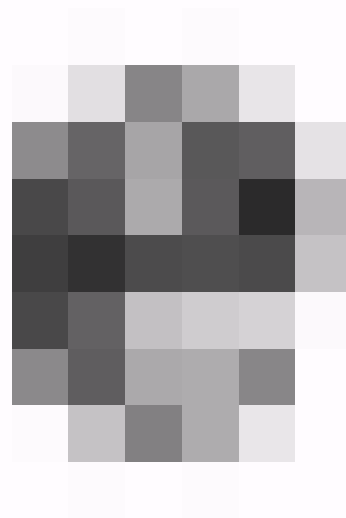
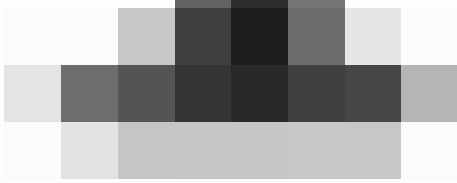
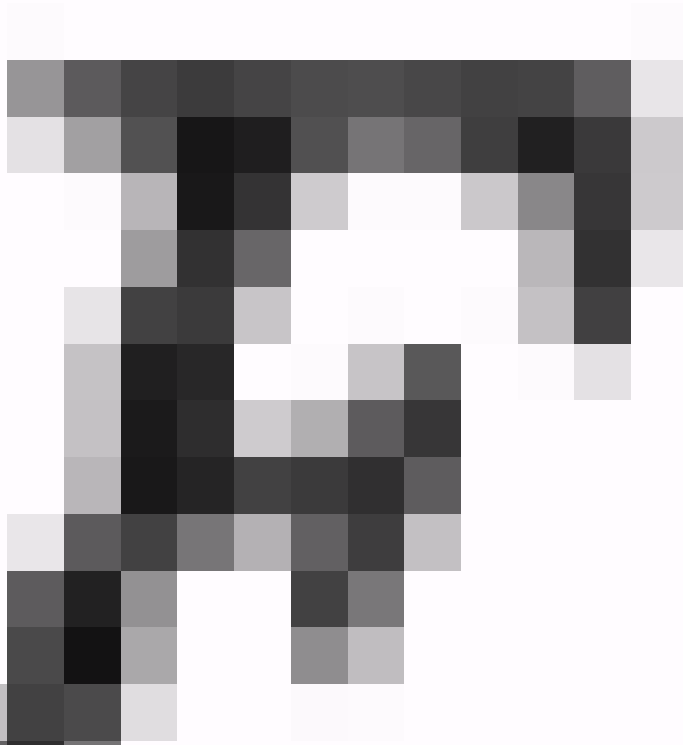
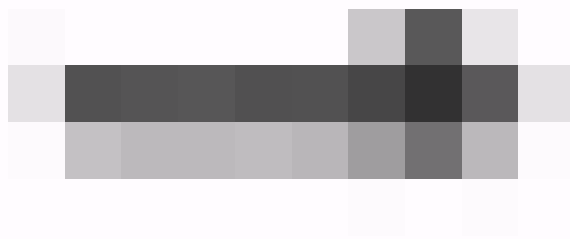



$A = Fd = QEd = 120$

THE UNIVERSITY OF CHICAGO
DEPARTMENT OF CHEMISTRY
520 SOUTH EAST ASIAN AVENUE
CHICAGO, ILLINOIS 60607
TEL: (773) 936-3700
WWW.CHEM.UCHICAGO.EDU

1935

A = QV

(35.13)

THE
MOUNTAIN
VIEW
SCHOOL

1910
1911
1912
1913
1914
1915
1916
1917
1918
1919
1920
1921
1922
1923
1924
1925
1926
1927
1928
1929
1930
1931
1932
1933
1934
1935
1936
1937
1938
1939
1940
1941
1942
1943
1944
1945
1946
1947
1948
1949
1950
1951
1952
1953
1954
1955
1956
1957
1958
1959
1960
1961
1962
1963
1964
1965
1966
1967
1968
1969
1970
1971
1972
1973
1974
1975
1976
1977
1978
1979
1980
1981
1982
1983
1984
1985
1986
1987
1988
1989
1990
1991
1992
1993
1994
1995
1996
1997
1998
1999
2000
2001
2002
2003
2004
2005
2006
2007
2008
2009
2010
2011
2012
2013
2014
2015
2016
2017
2018
2019
2020
2021
2022
2023
2024
2025
2026
2027
2028
2029
2030
2031
2032
2033
2034
2035
2036
2037
2038
2039
2040
2041
2042
2043
2044
2045
2046
2047
2048
2049
2050
2051
2052
2053
2054
2055
2056
2057
2058
2059
2060
2061
2062
2063
2064
2065
2066
2067
2068
2069
2070
2071
2072
2073
2074
2075
2076
2077
2078
2079
2080
2081
2082
2083
2084
2085
2086
2087
2088
2089
2090
2091
2092
2093
2094
2095
2096
2097
2098
2099
2100

VEED (3D.14)

1990

1991

1992

1993

i

E

=

V

—

d

(35.15).

1

1000

1000

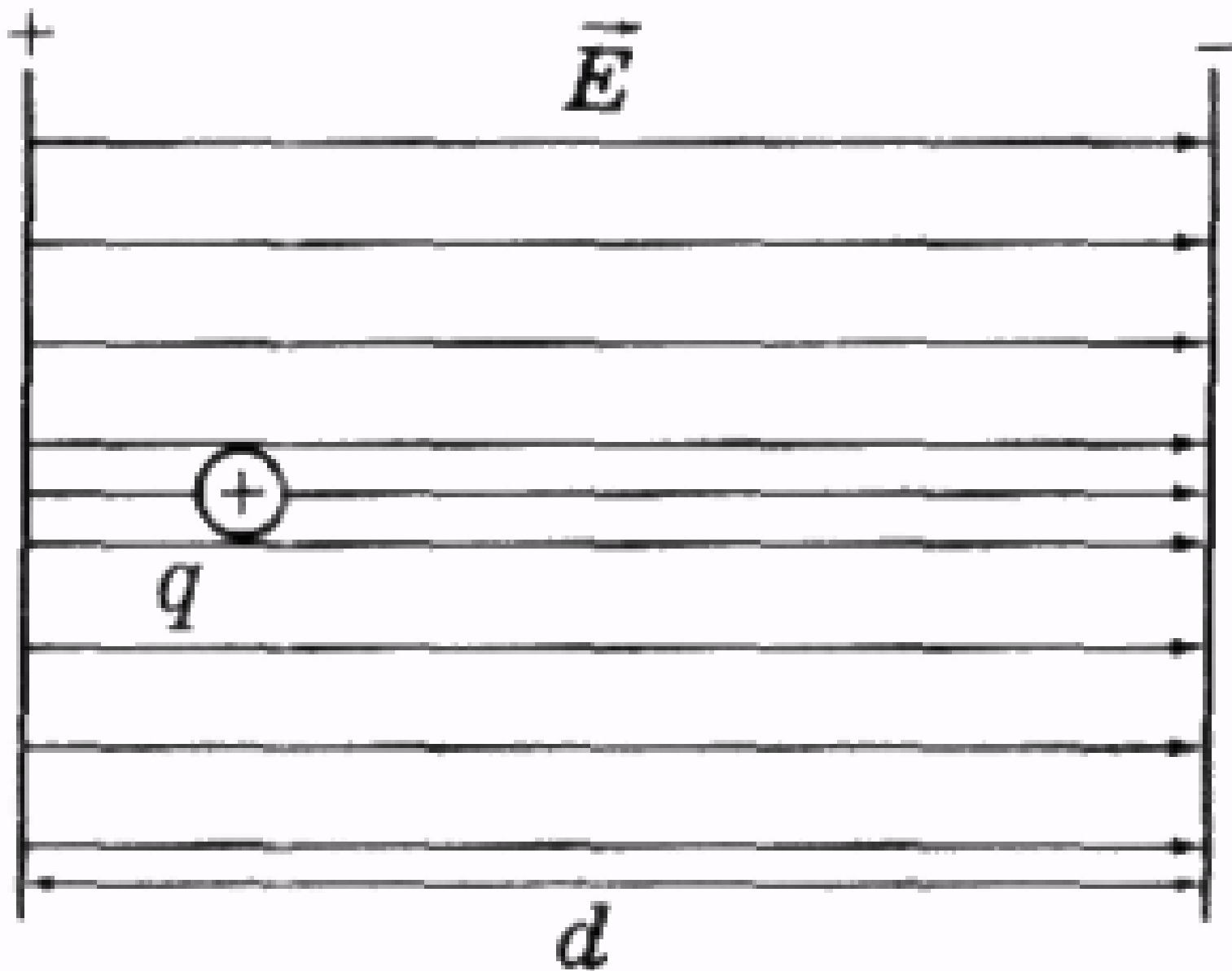

Мал. 2.109

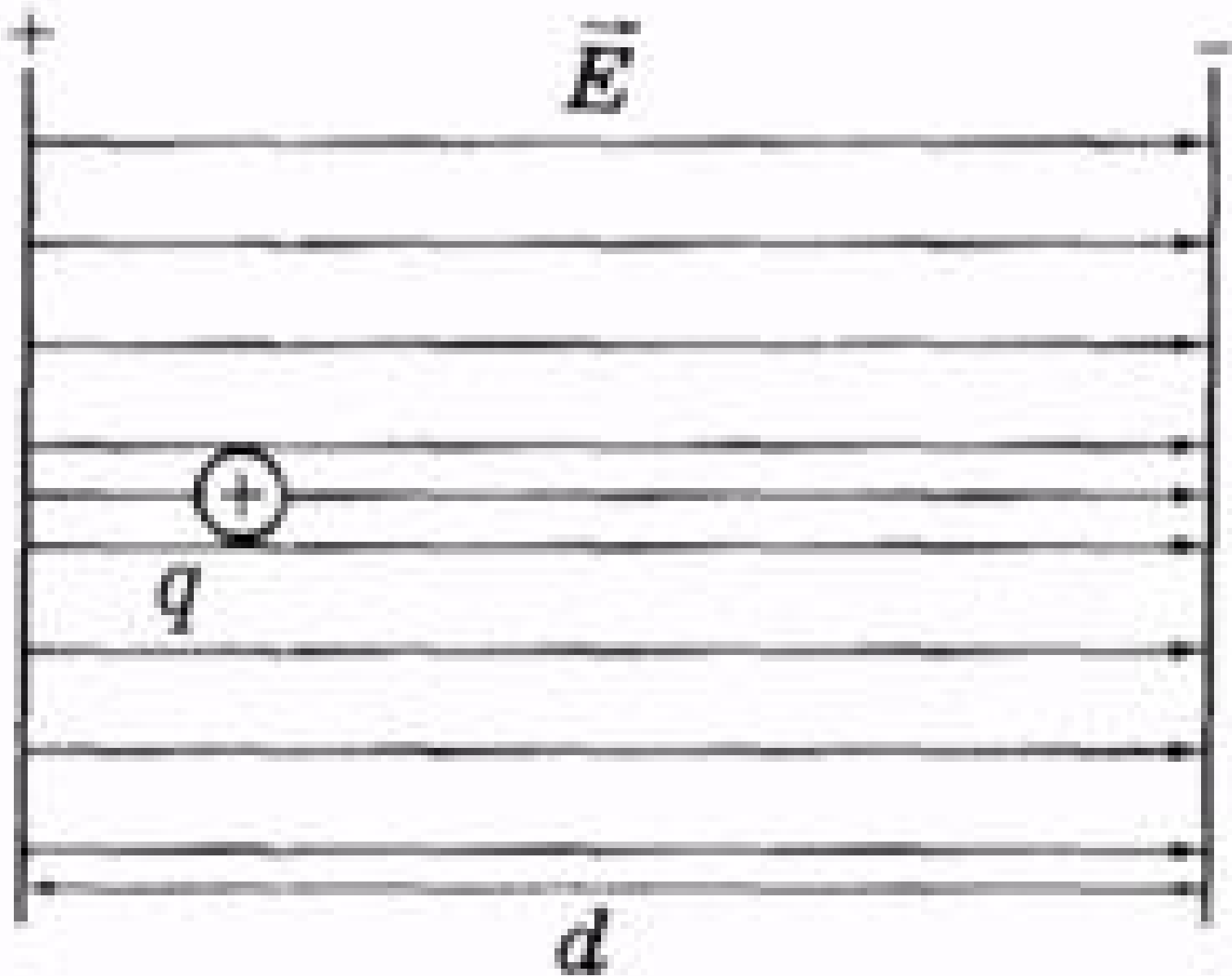

Мал. 2.109

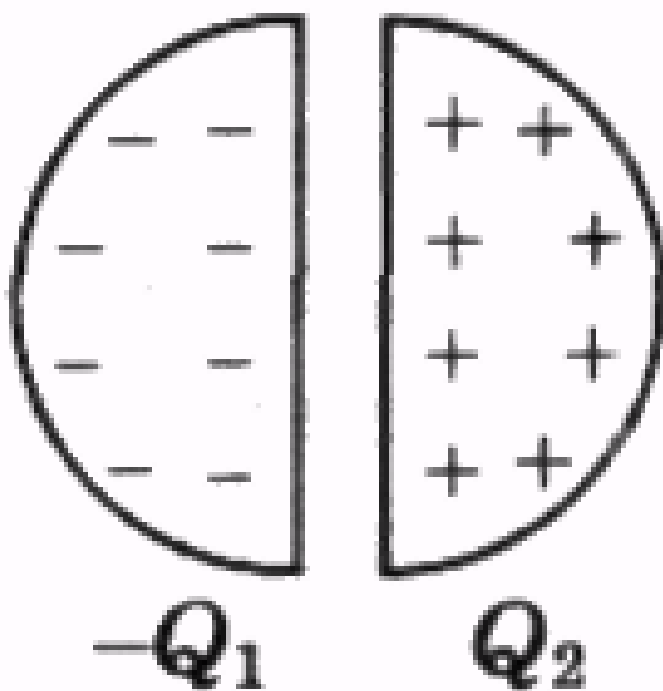
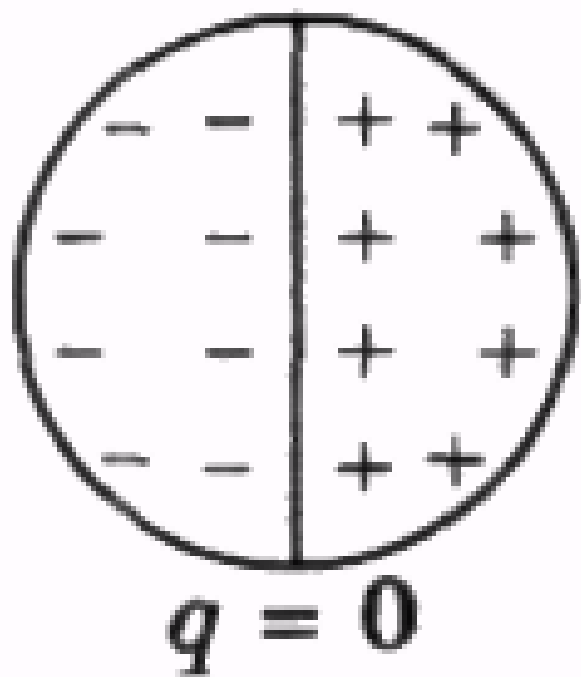
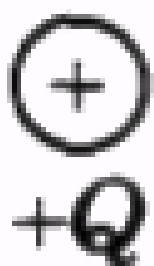
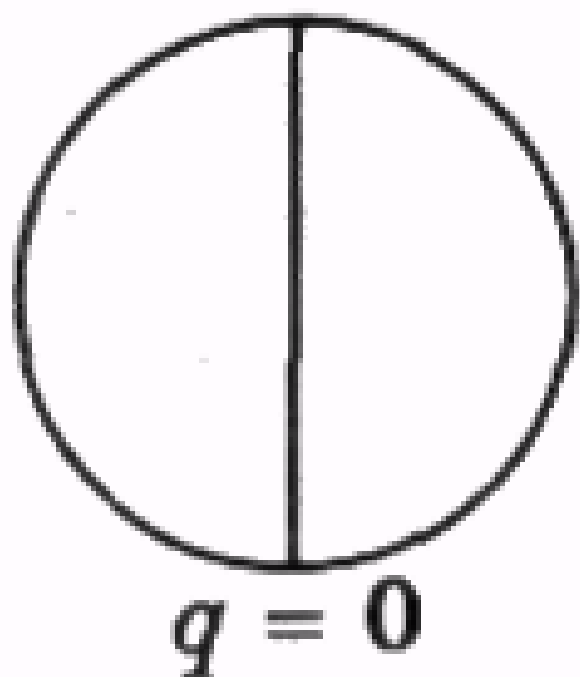

$$q = -Q_1 + Q_2 = 0$$

Мал. 2.110

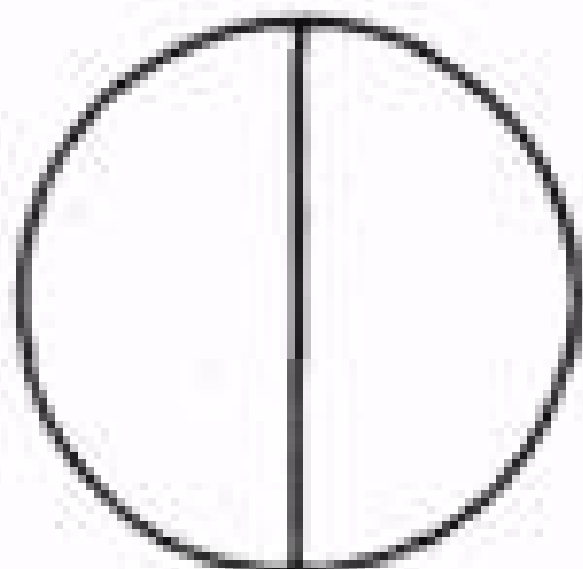

$$q = 0$$



$$+Q$$

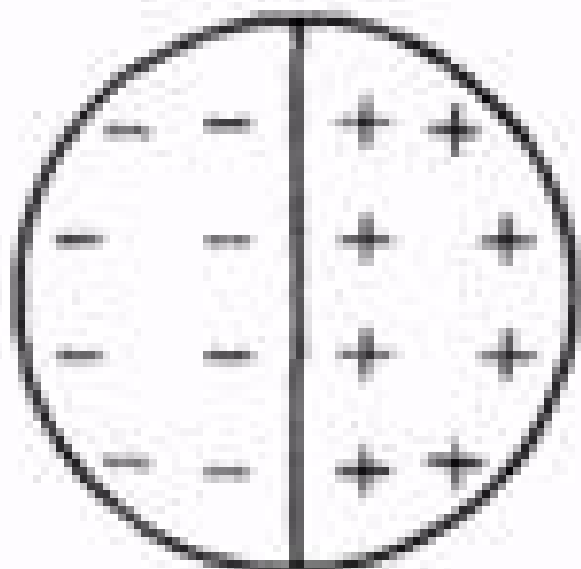

$$q = 0$$

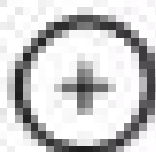

$$+Q$$

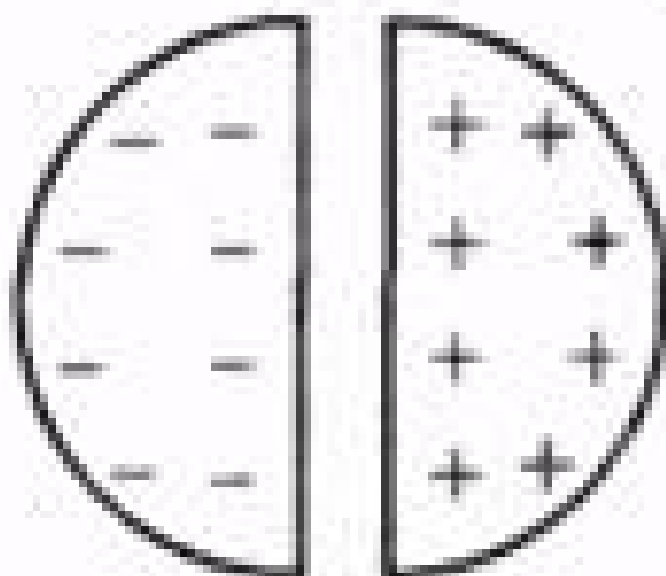

$$-Q_1$$

$$Q_2$$

$$q = -Q_1 + Q_2 = 0$$

Мал. 2.110

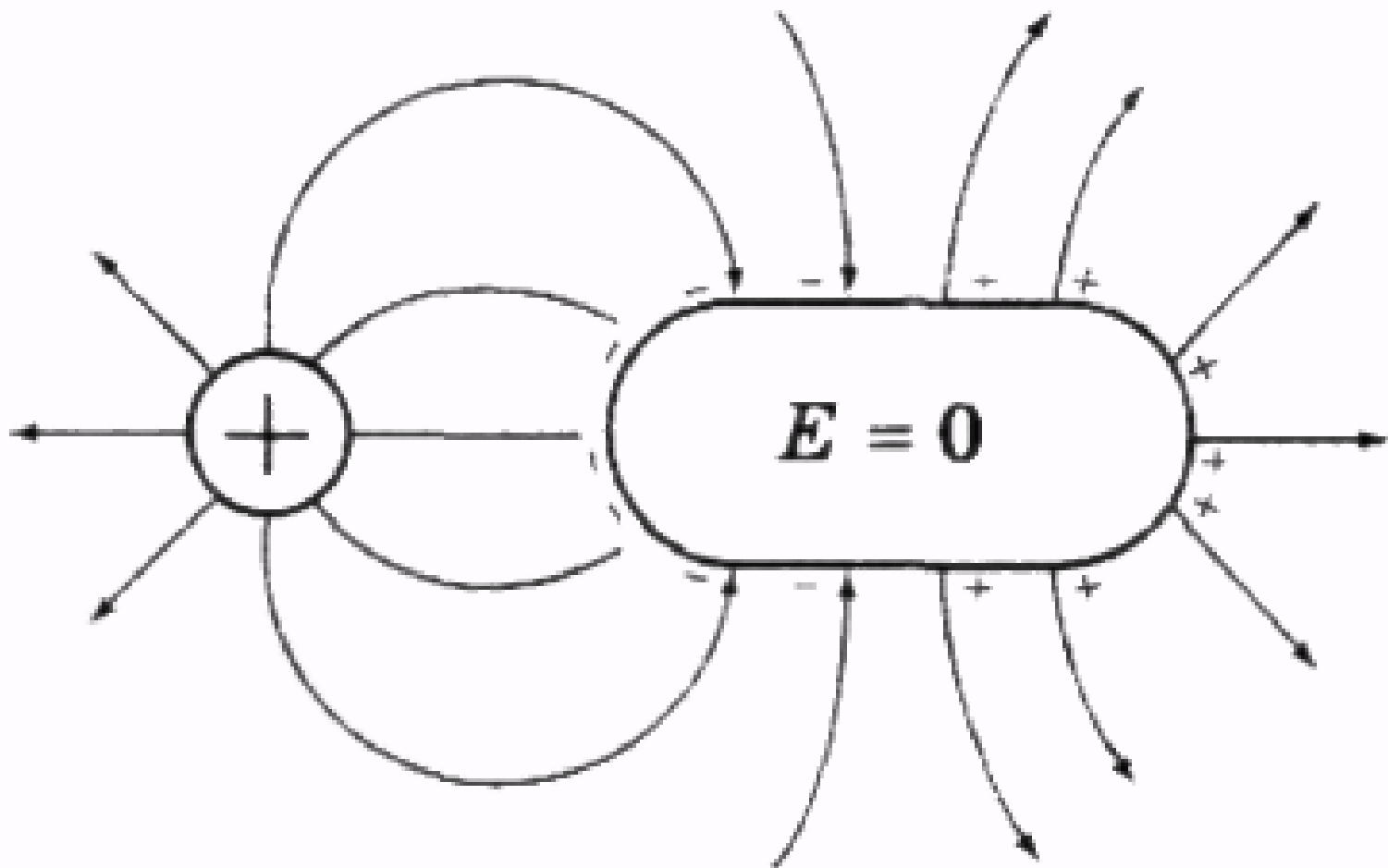

Мал. 2.111

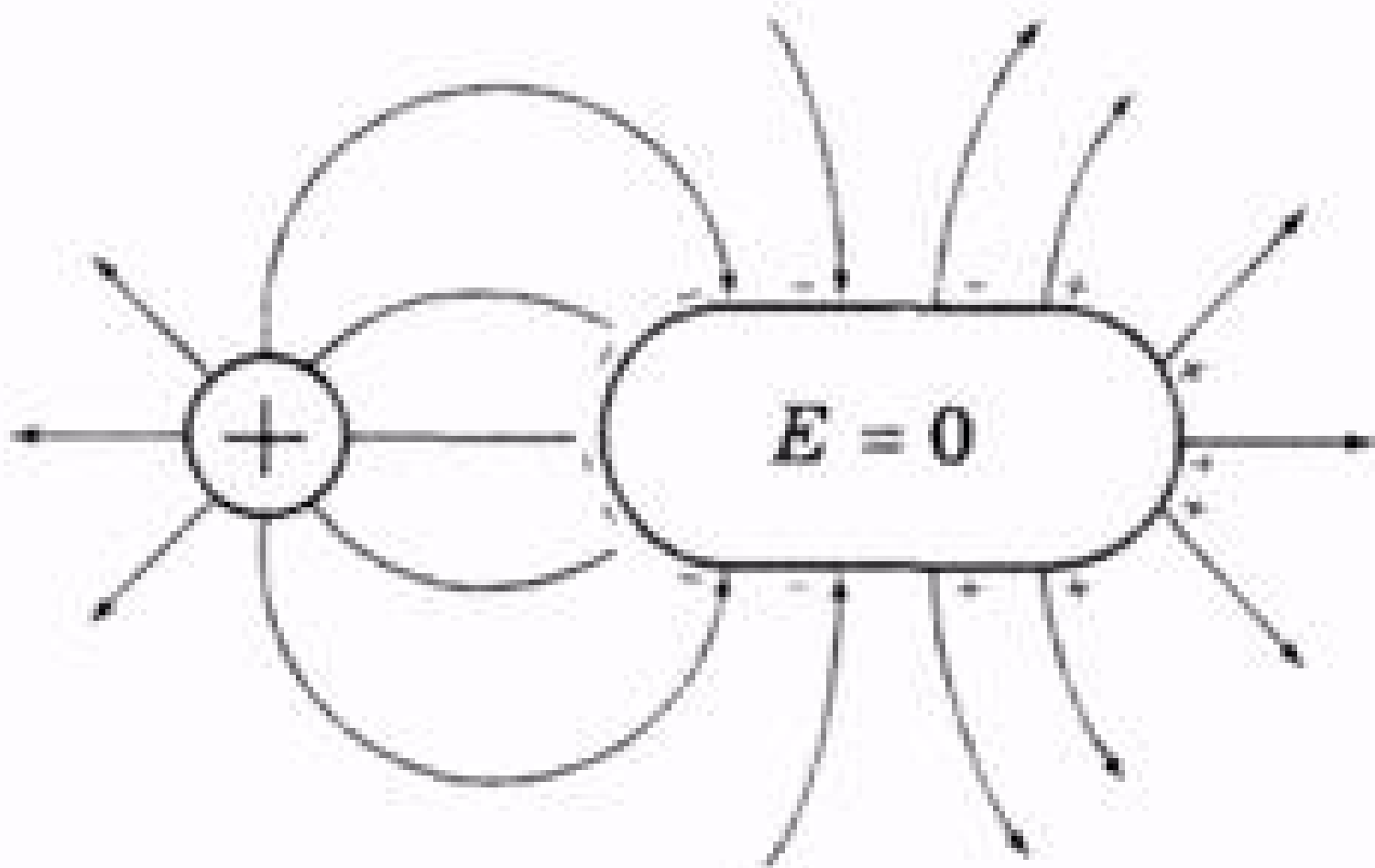

Мал. 2.111

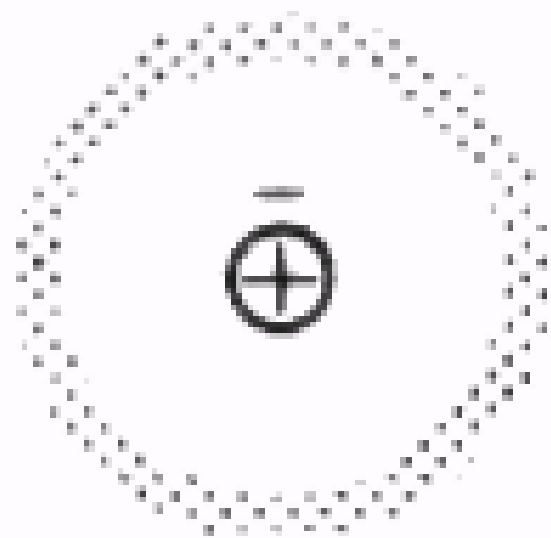

$$E = 0$$

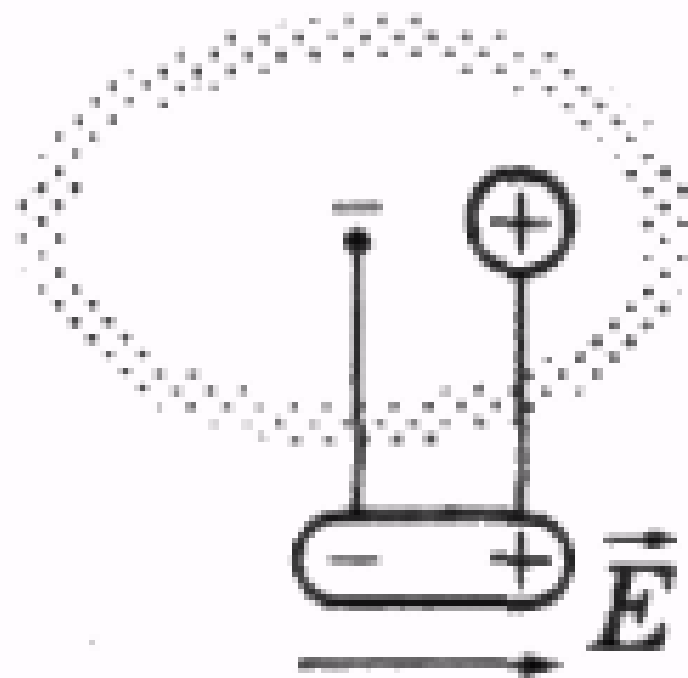

Мал. 2.112



$$E = 0$$

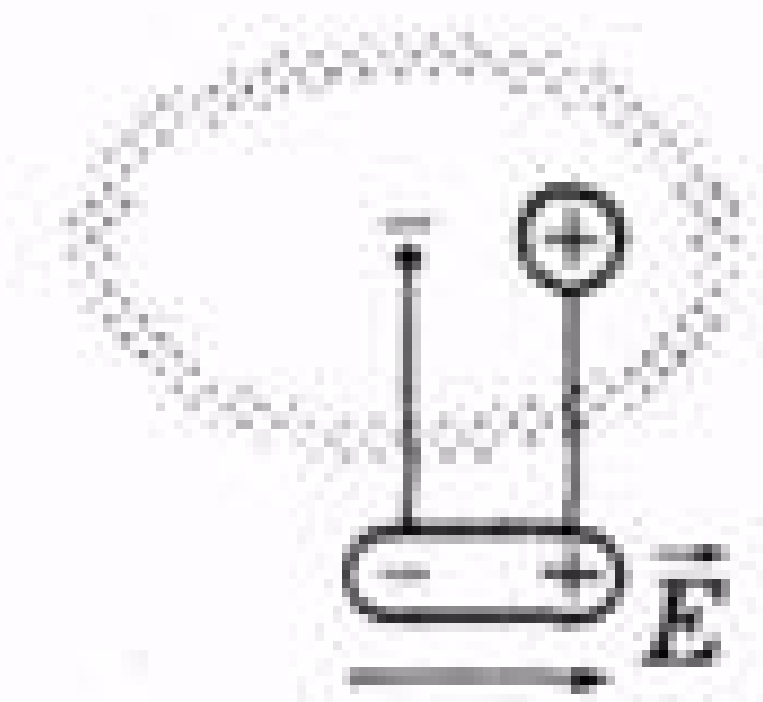

Mat. 2.112

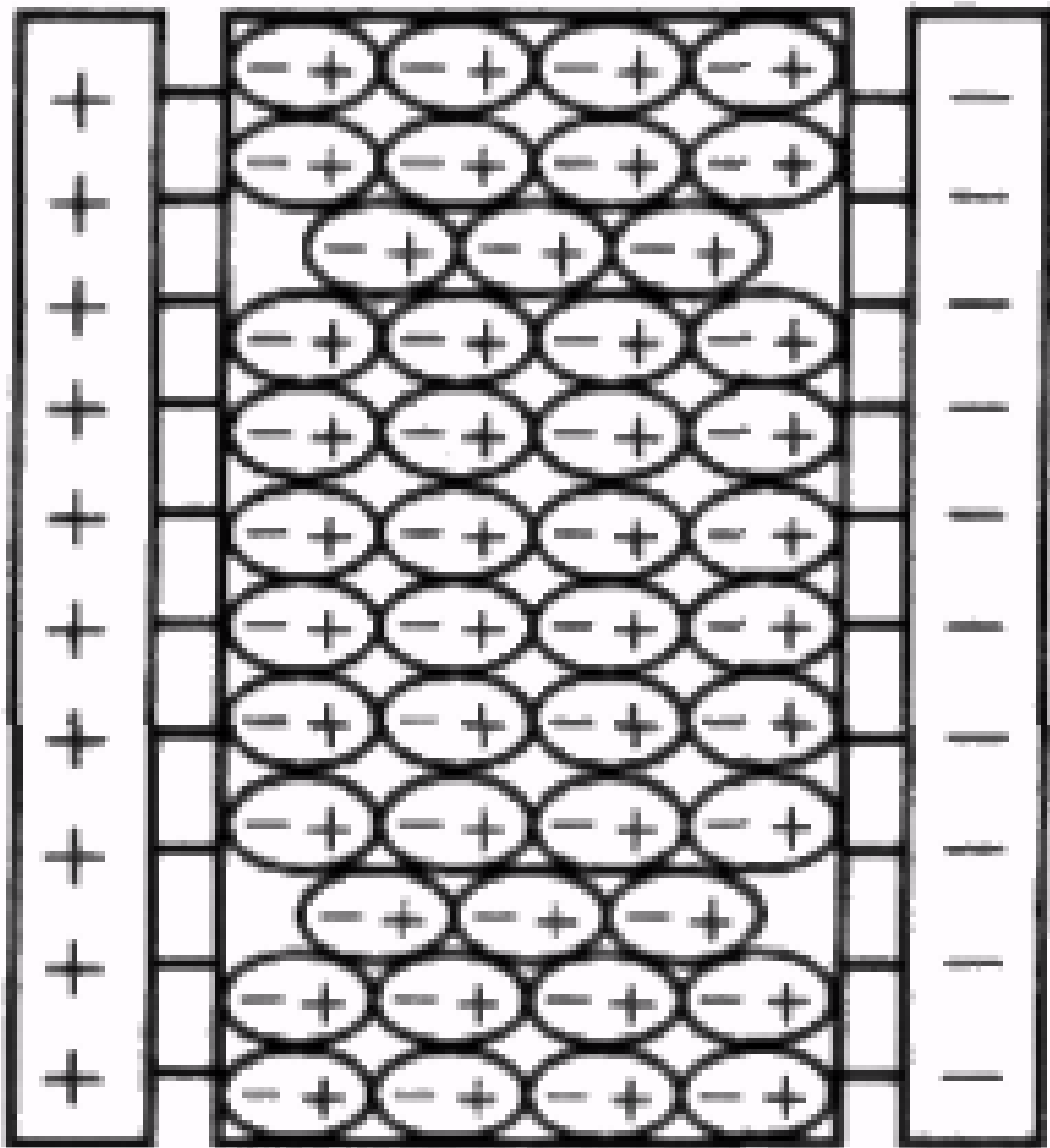

Мал. 2.113

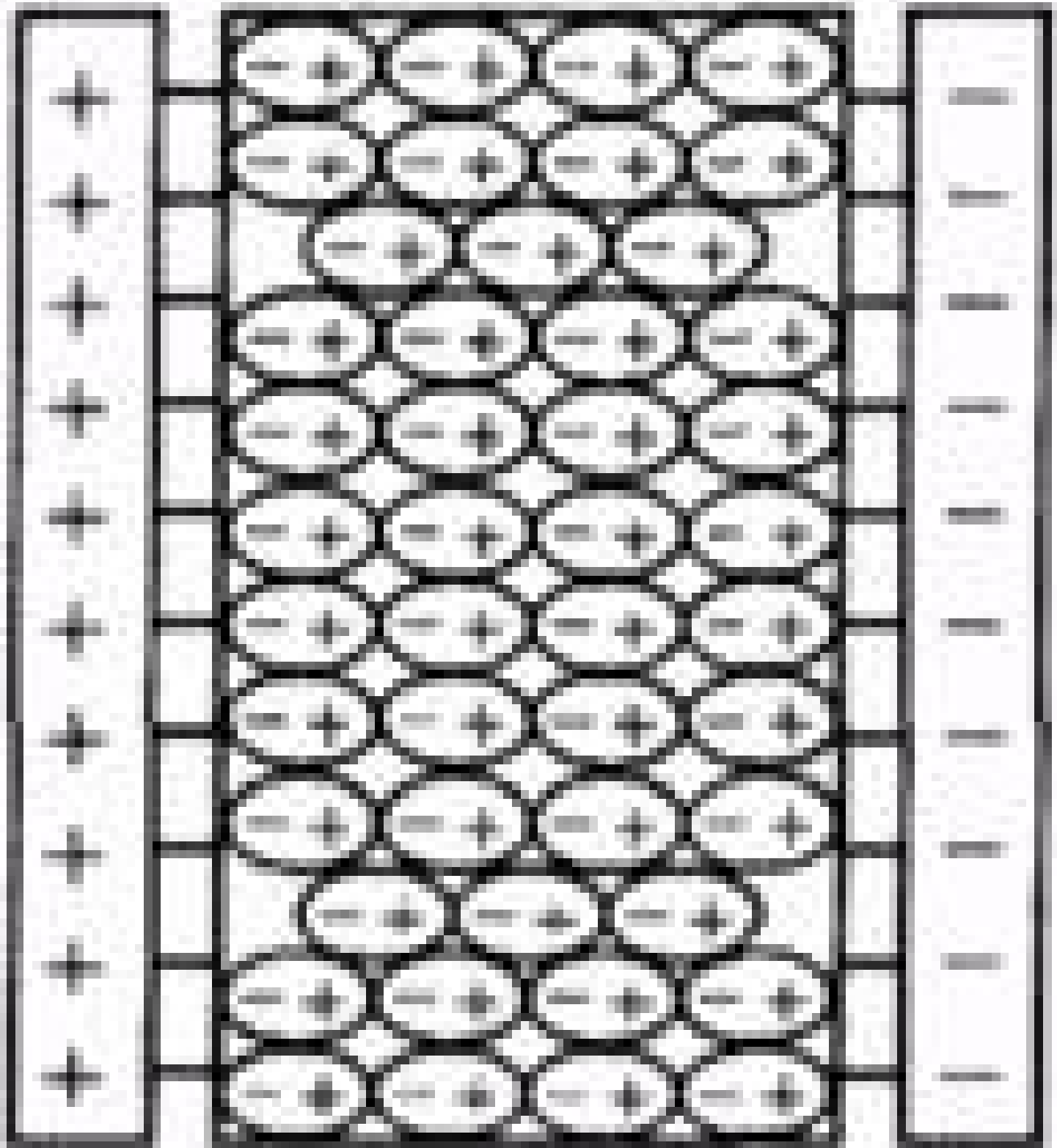

Mat. 2.113

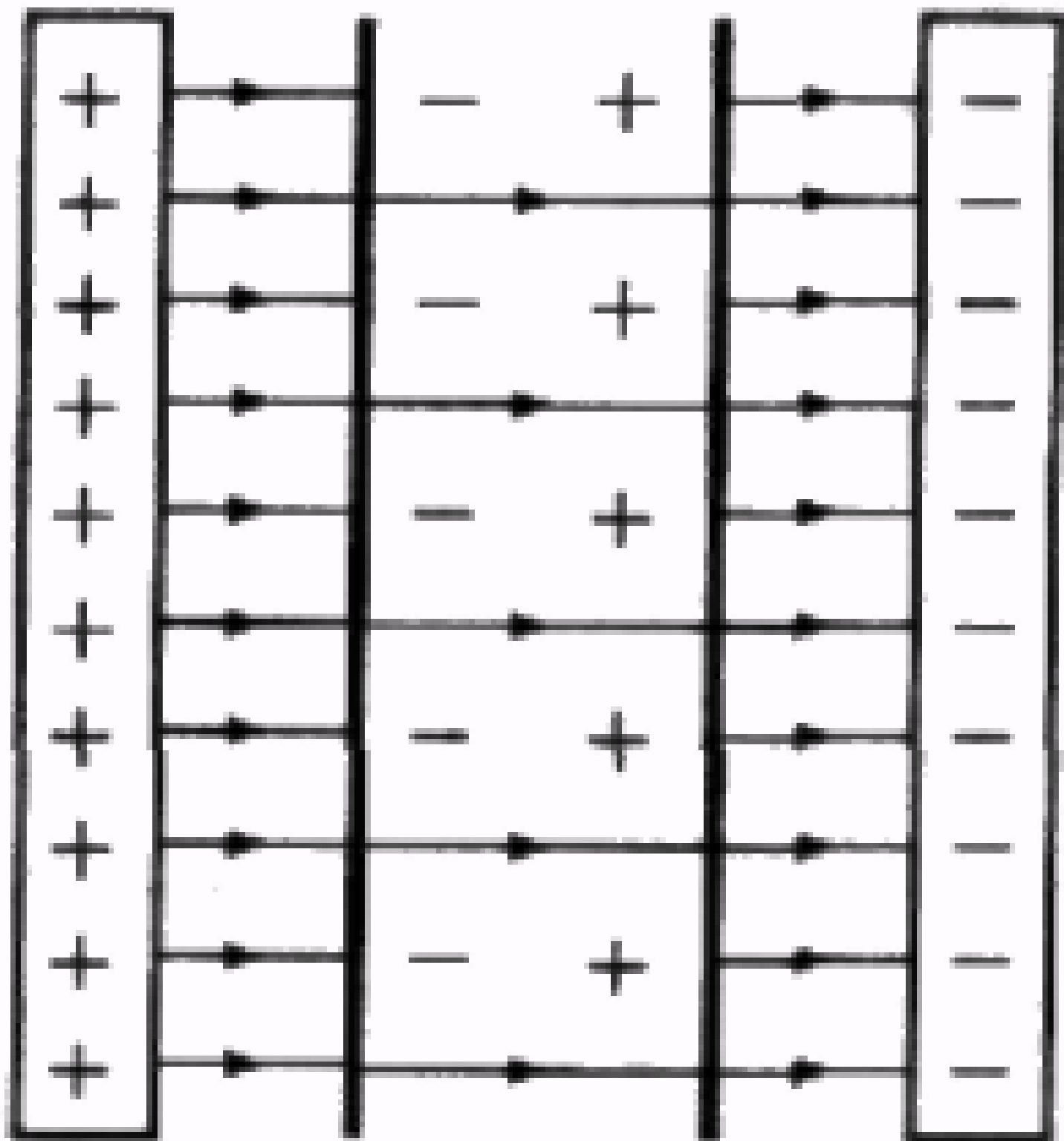

Мал. 2.114

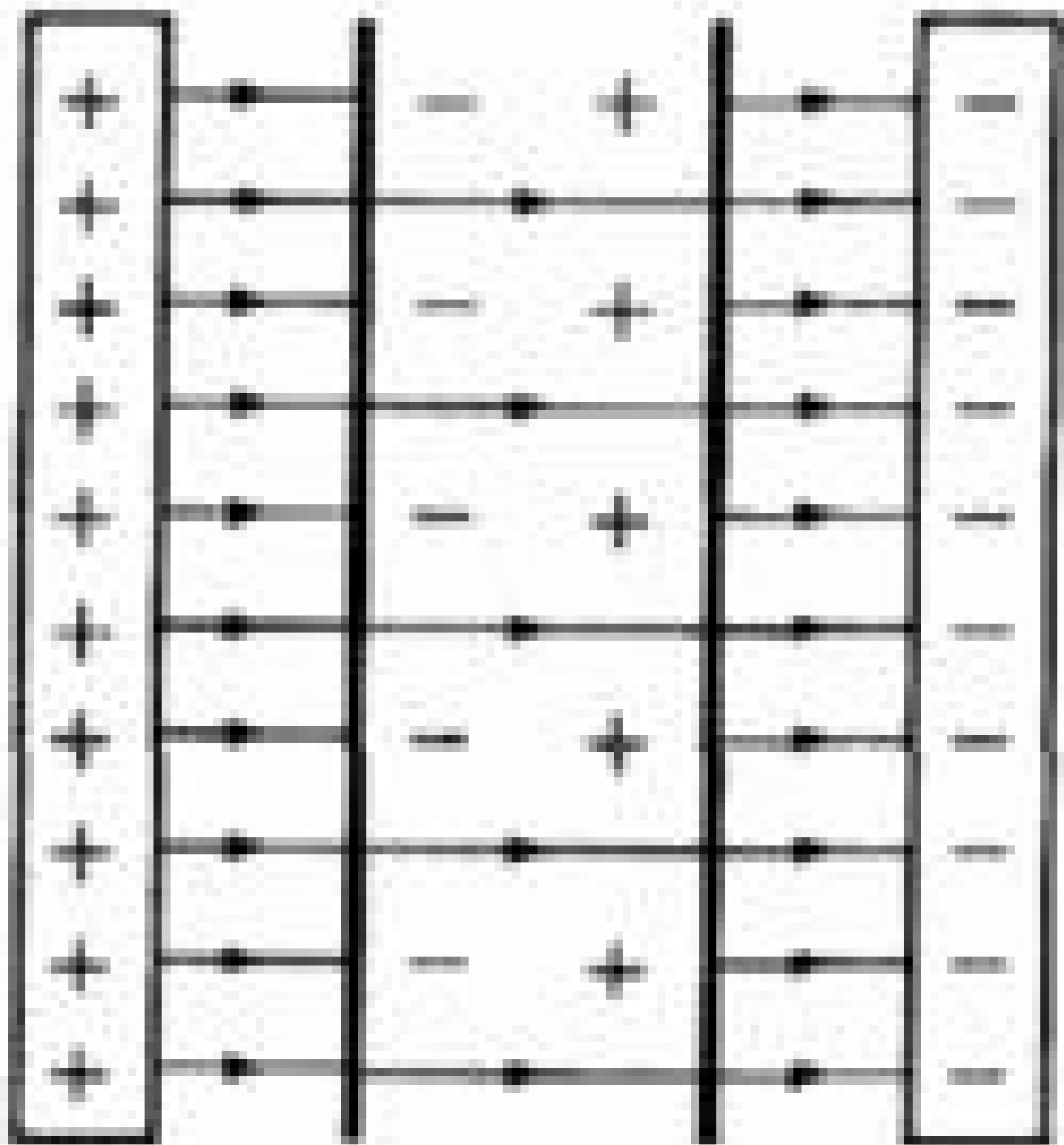

Мал. 2.114

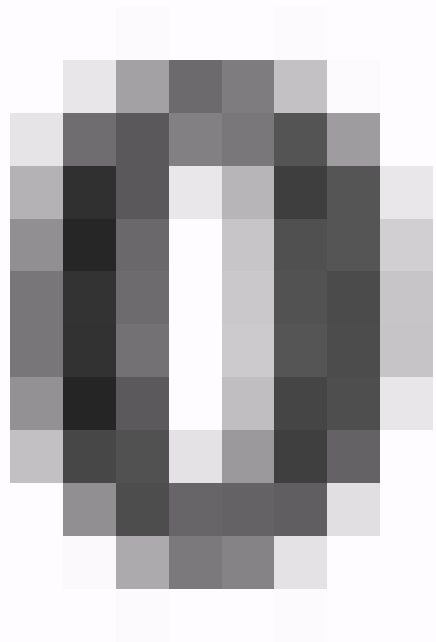
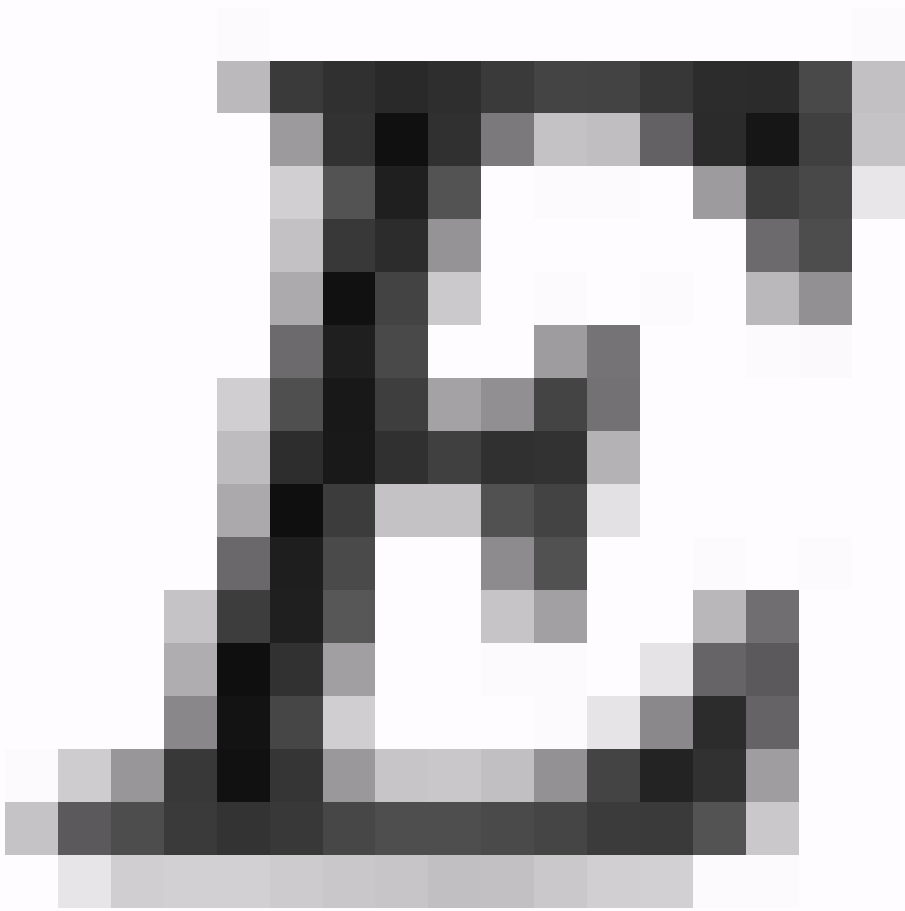



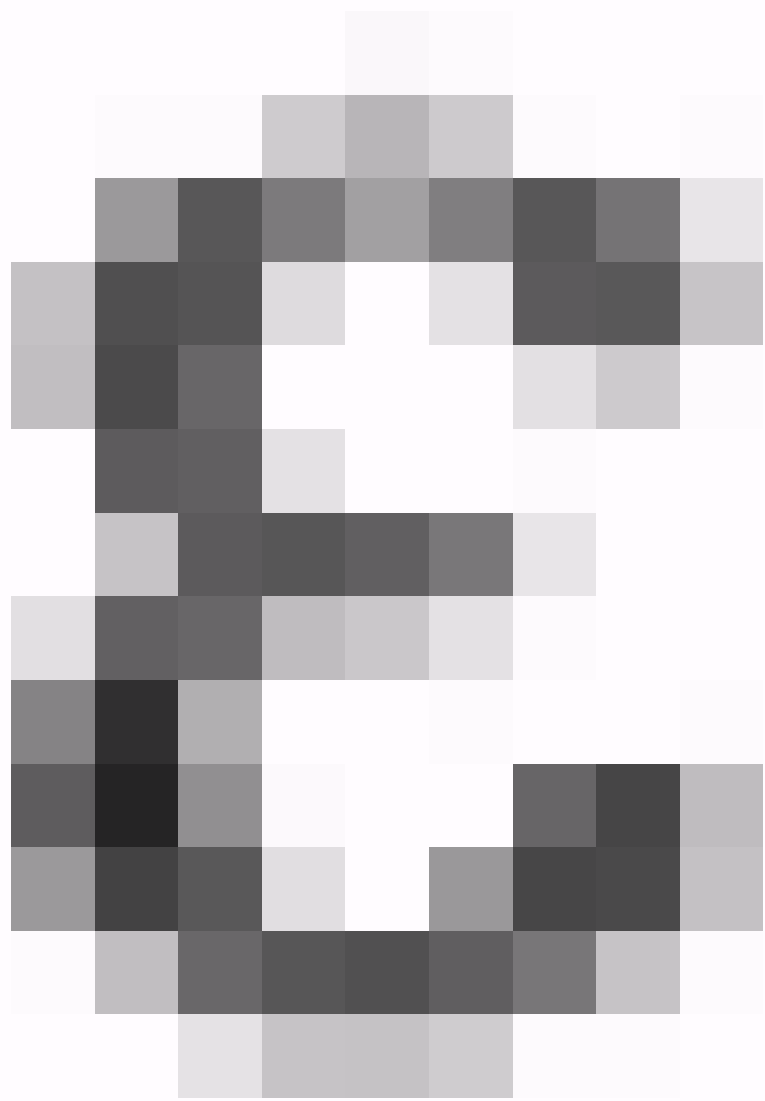



$$\epsilon = \frac{E_0}{E} \quad (36.1)$$

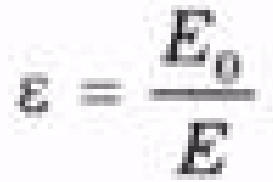

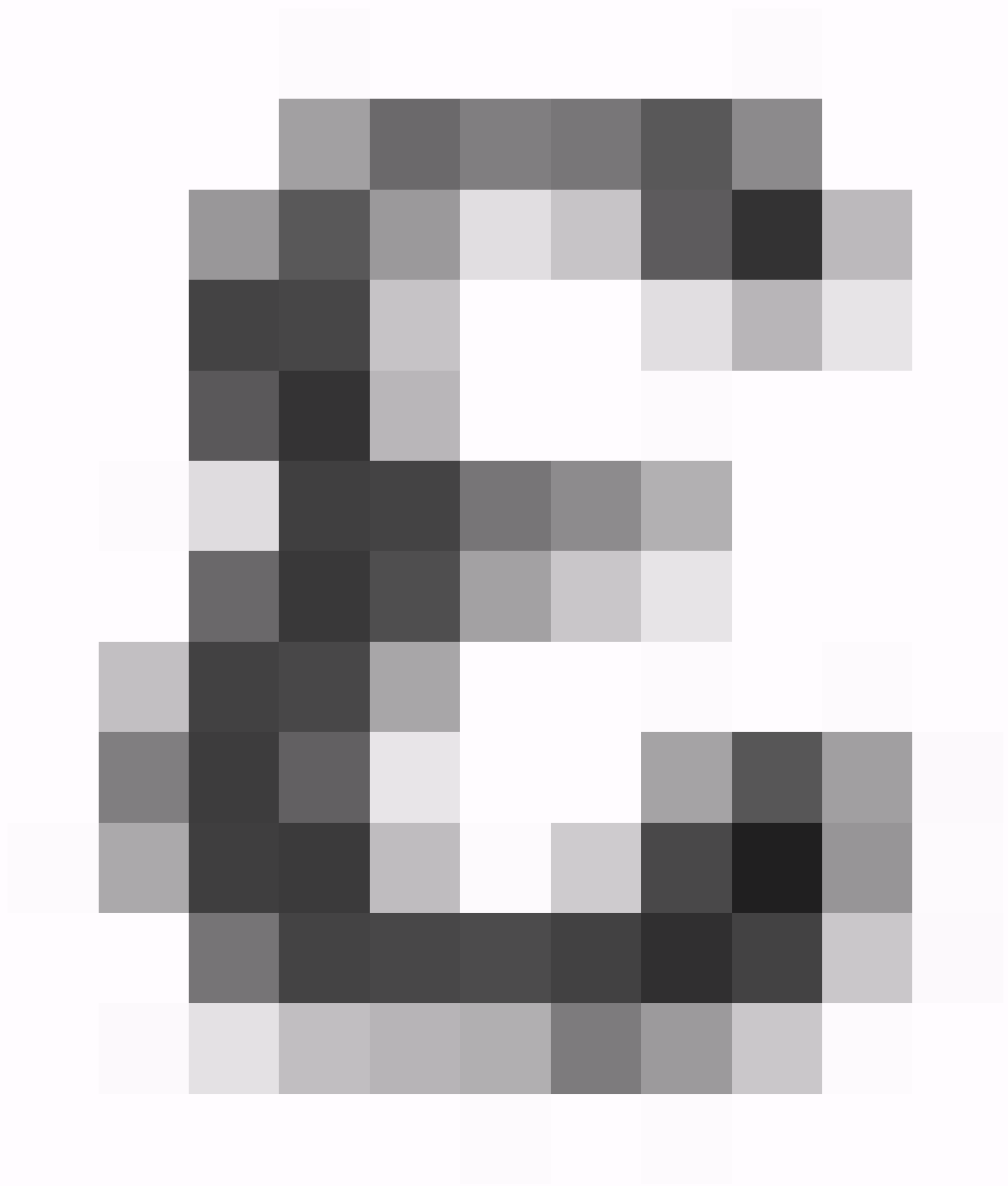



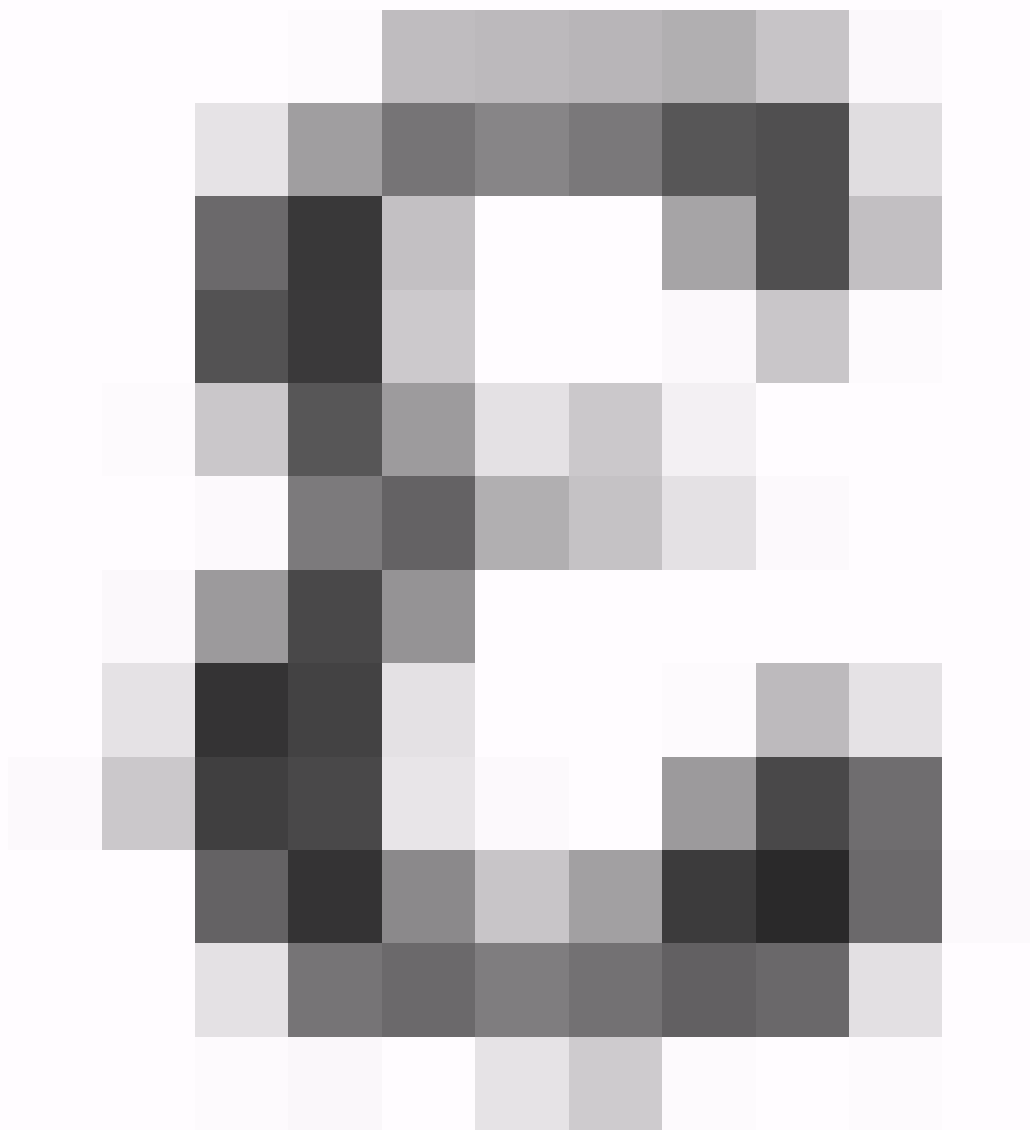

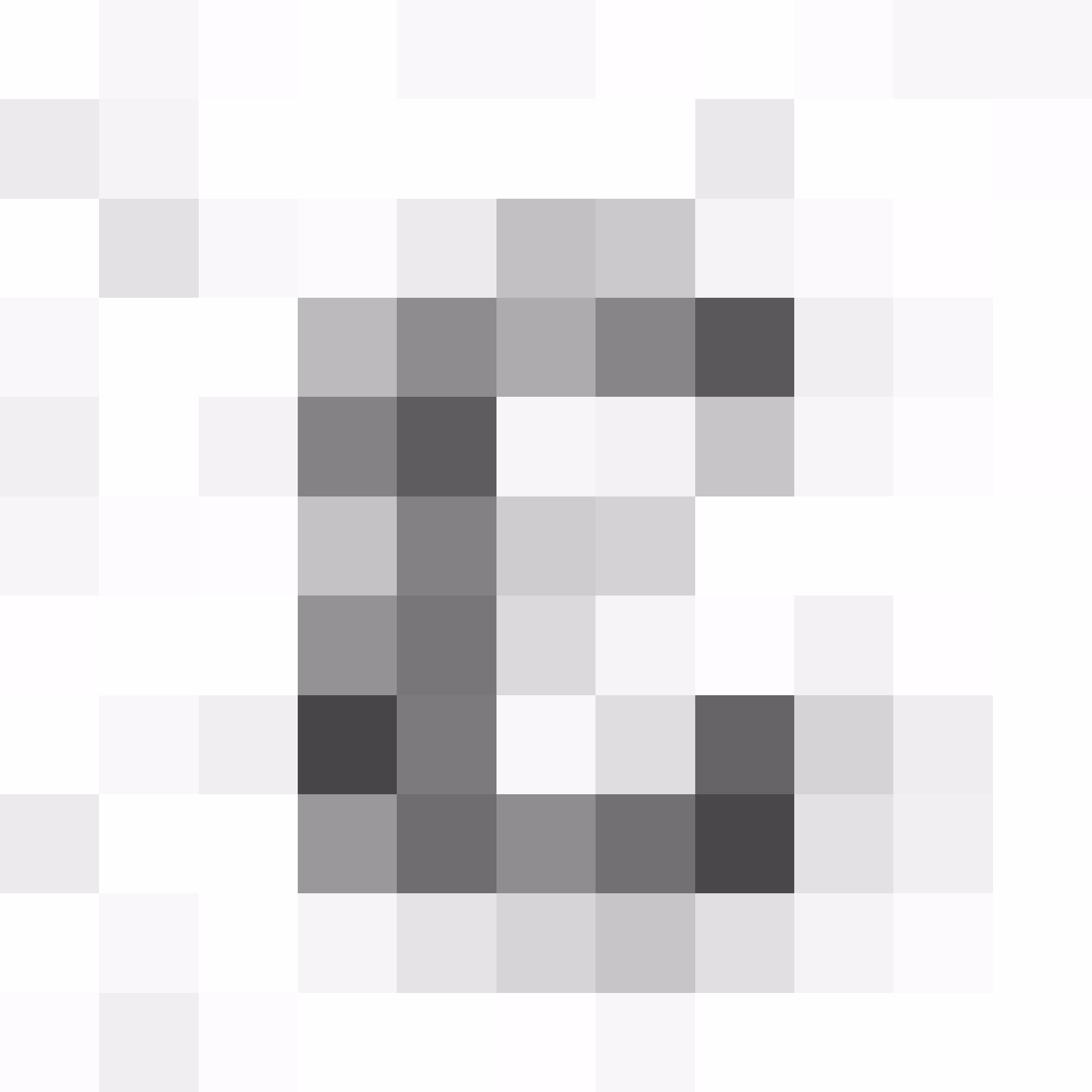

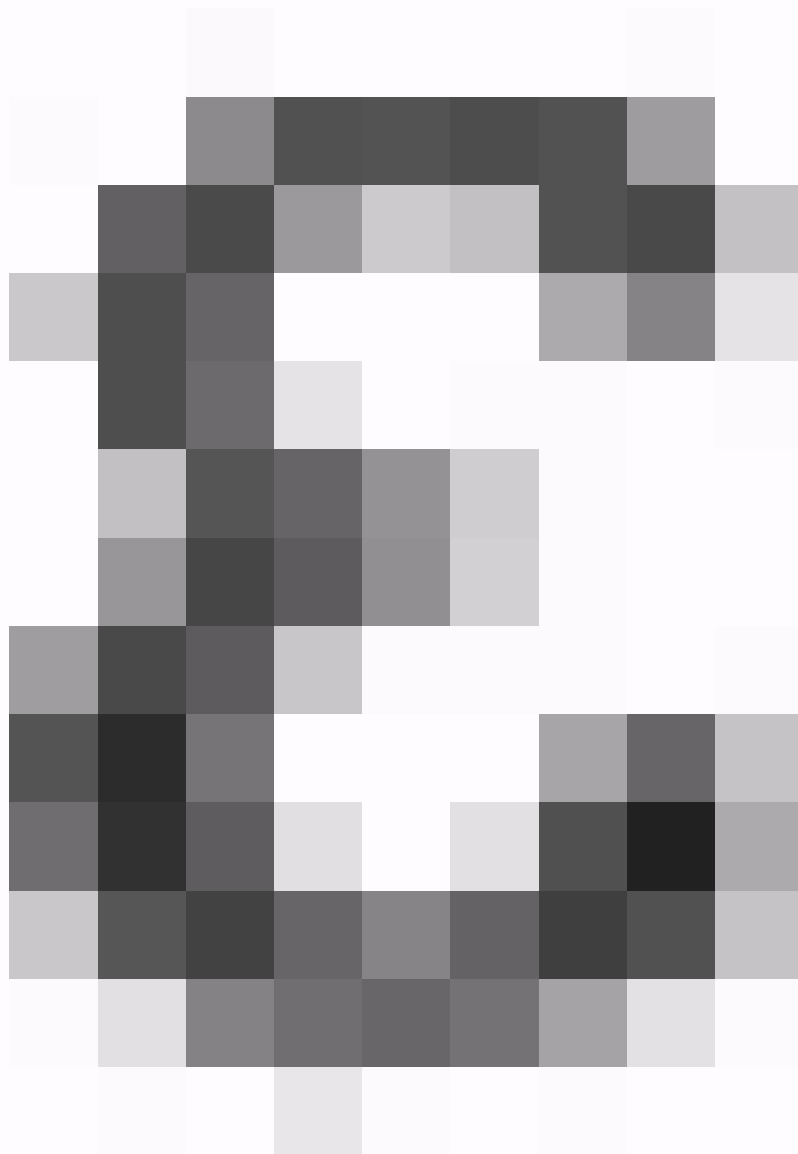

$$F_e = N \frac{Q_1 \cdot Q_2}{\epsilon r^2} \quad (36.2)$$

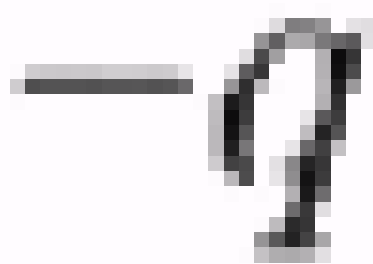
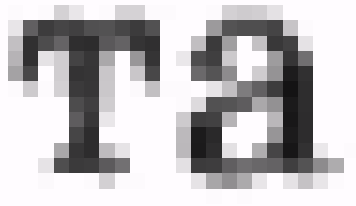
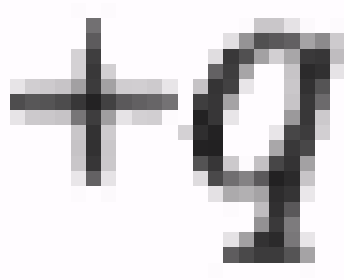

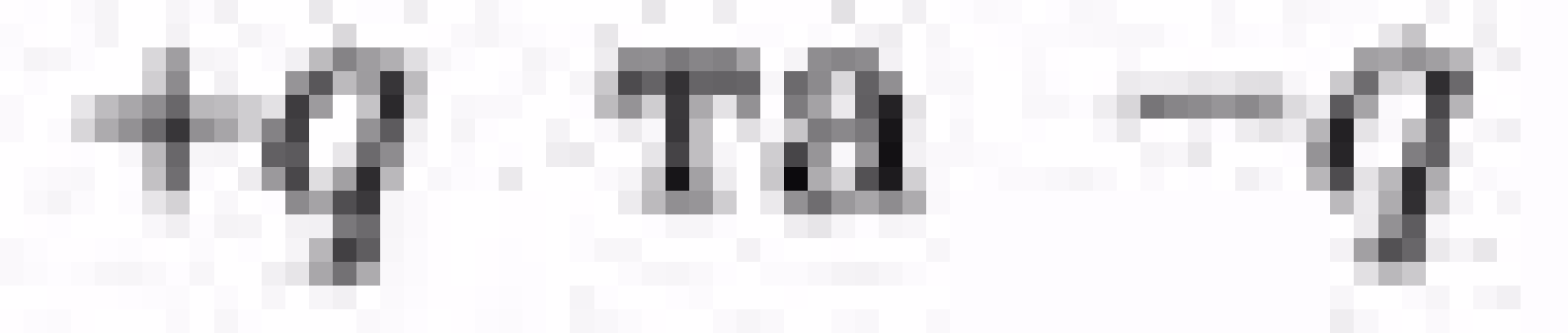

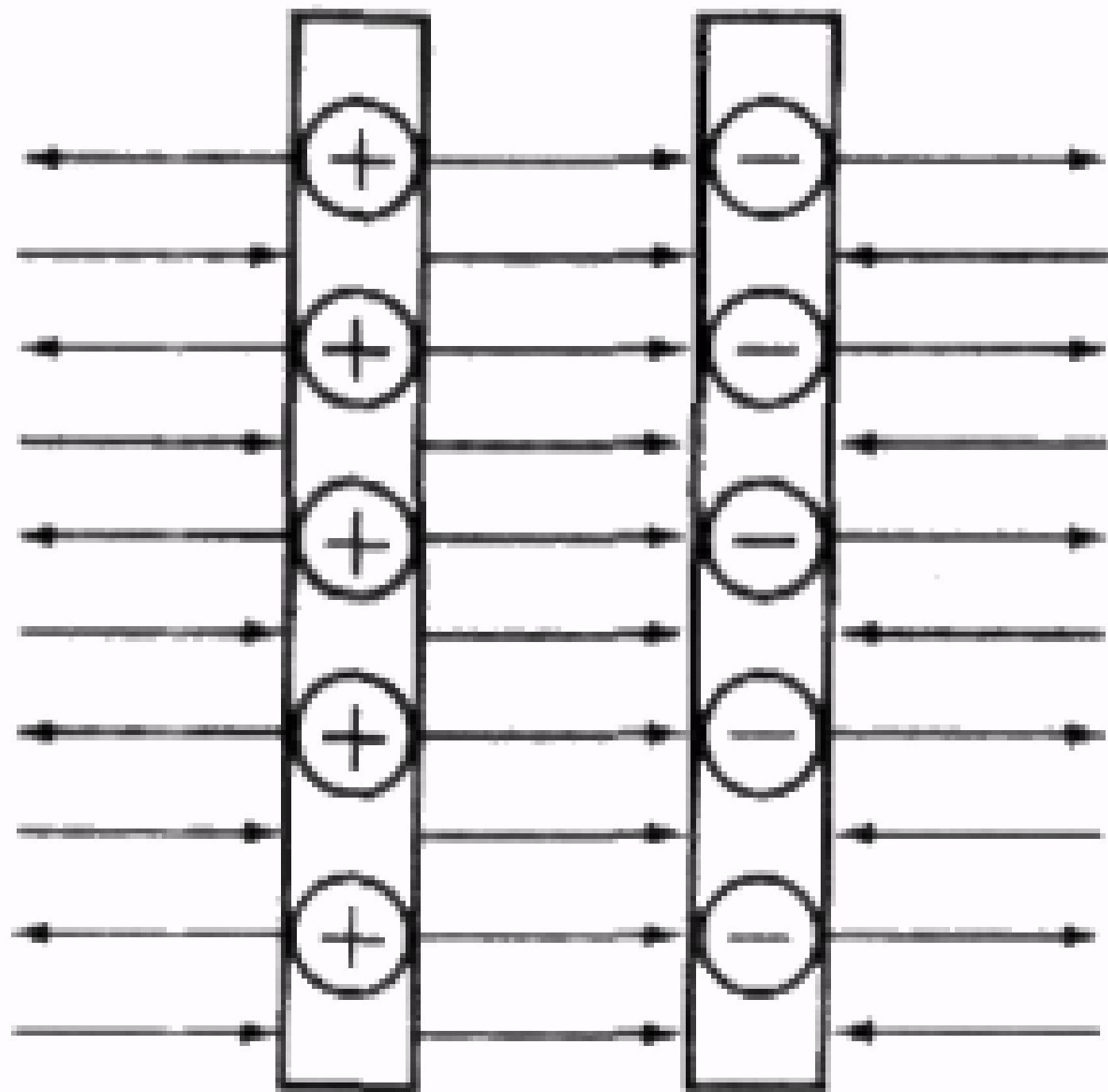

Мал. 2.115

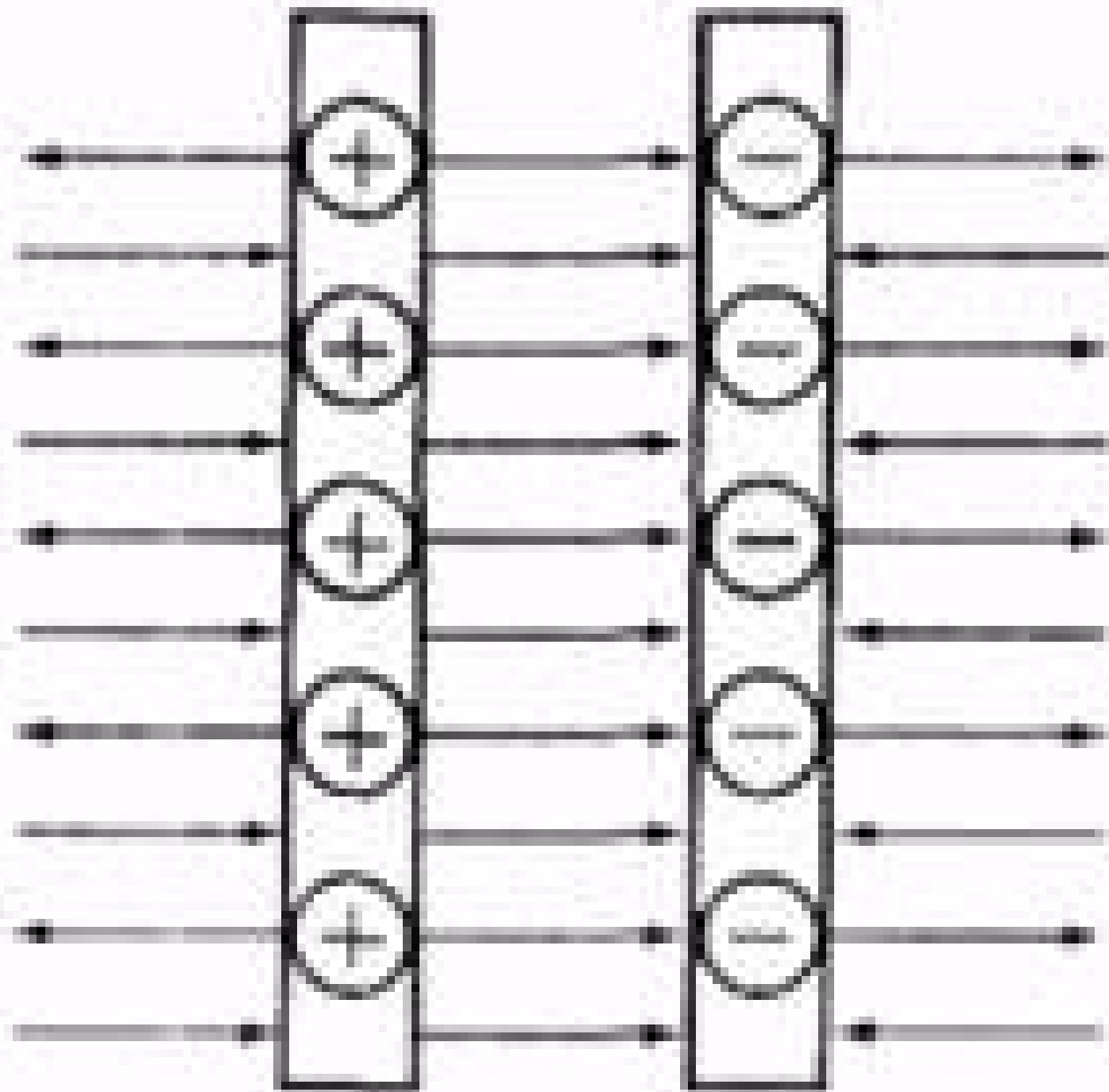

Мал. 2.115

$$c = \frac{Q}{V} \quad (36.3)$$

1000

1000

$$1 \Phi = \frac{1 \kappa \pi}{1 B} .$$

100

=

100

1

100

$$1 \text{ МКФ} = 10^{-6} \text{ Ф};$$

$$1 \text{ нФ} = 10^{-9} \text{ Ф};$$

$$1 \text{ пФ} = 10^{-12} \text{ Ф}.$$

$$I_{MK\Phi} = 10^{-6} \Phi;$$

$$I_{H\Phi} = 10^{-8} \Phi;$$

$$I_{n\Phi} = 10^{-12} \Phi.$$

$$C = \frac{E \cdot S}{d}$$

(36.4)

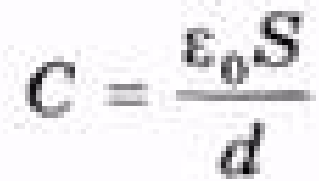

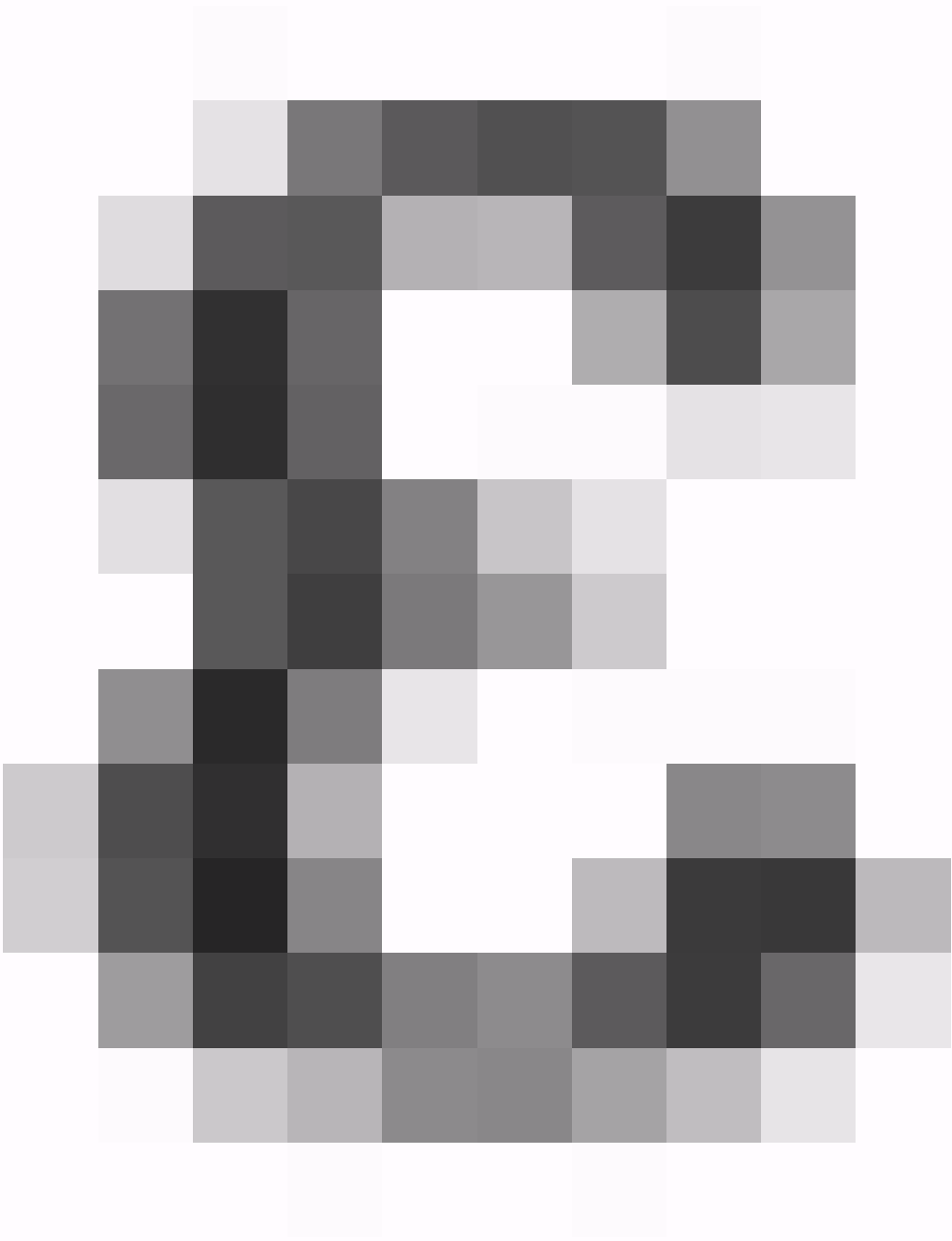



$$C = \frac{\epsilon \epsilon_0 S}{d} \quad (36.5)$$

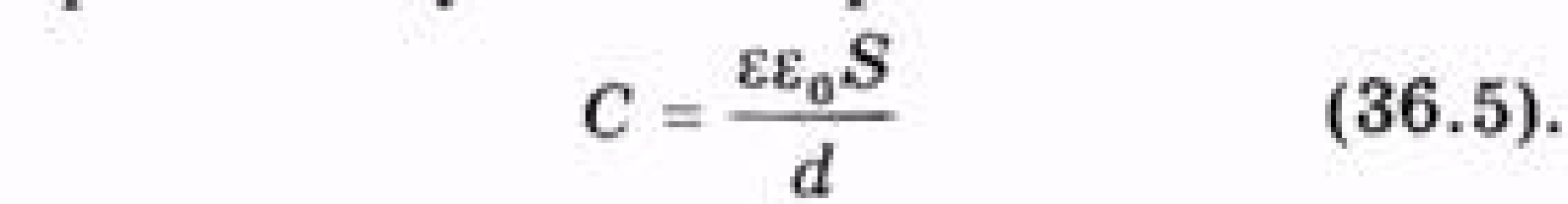

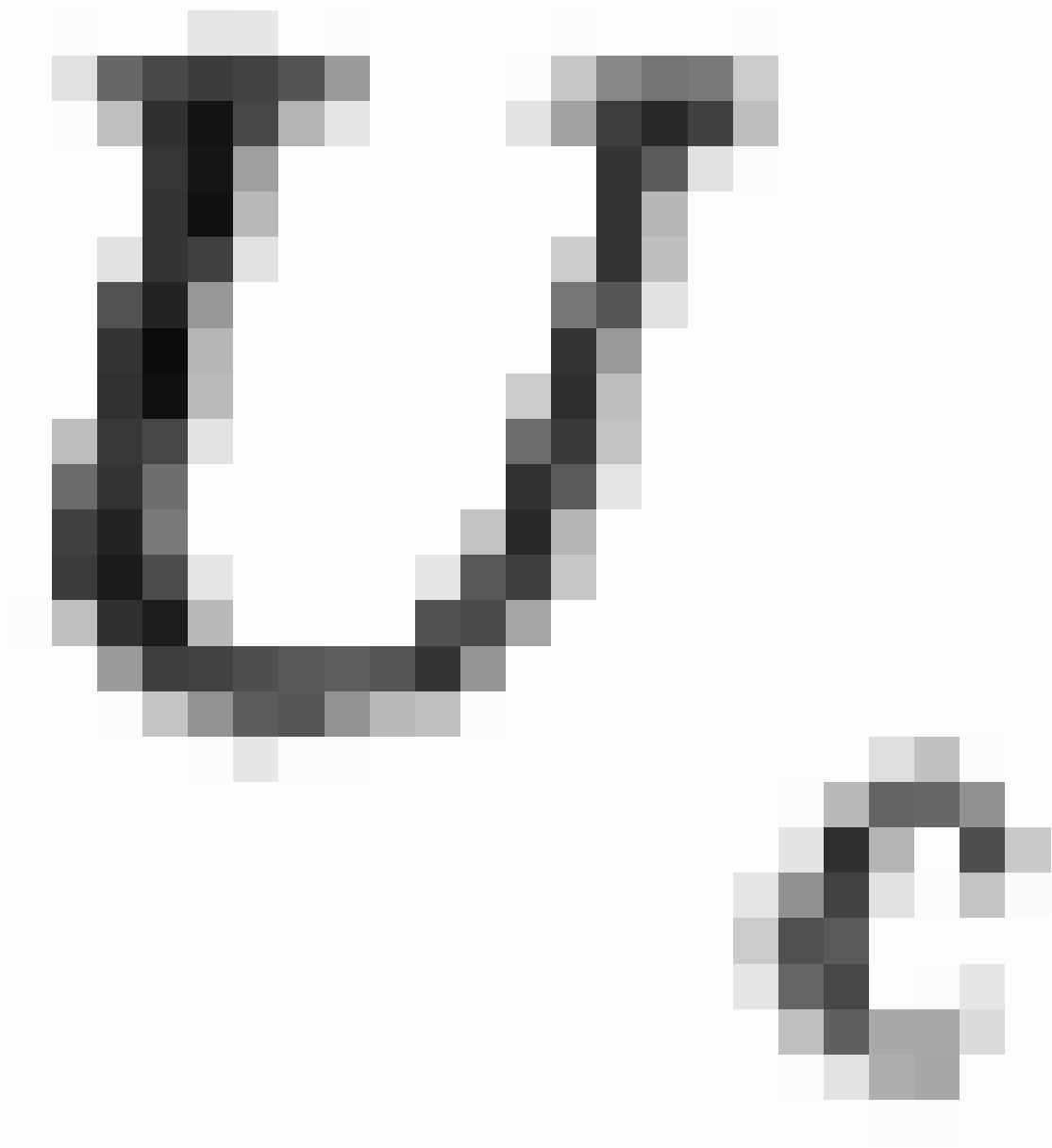



V

c

=

V

—

2

+



$$A = qv_e = \frac{qv}{2} \quad (30.6)$$



$$A = \frac{CV^2}{2} \quad (36.7)$$



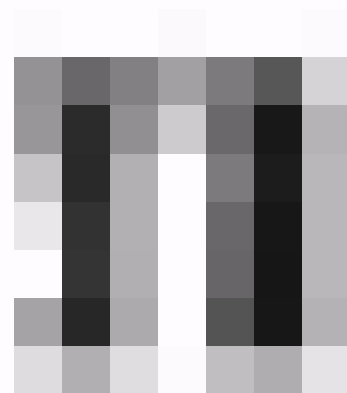
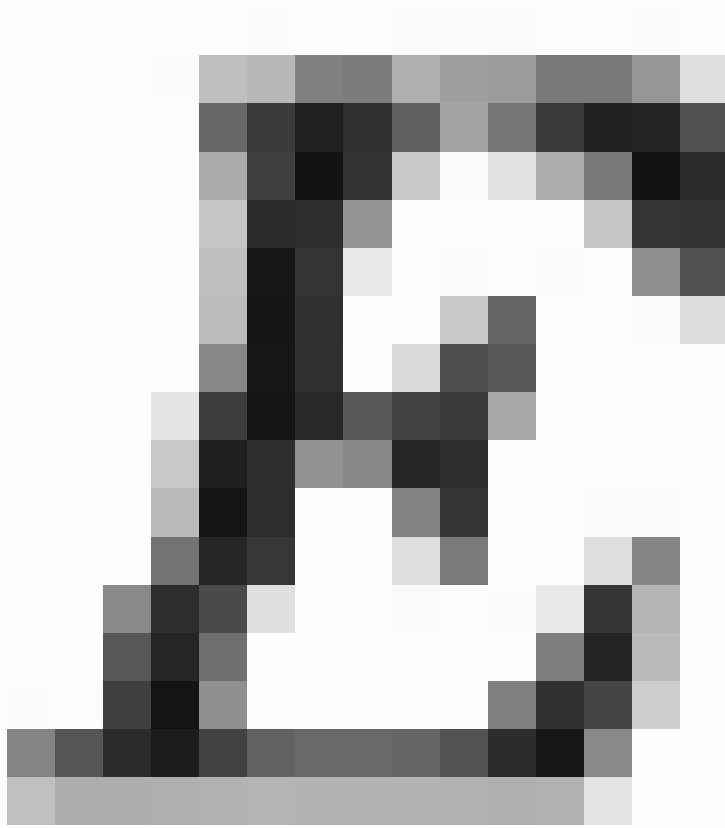

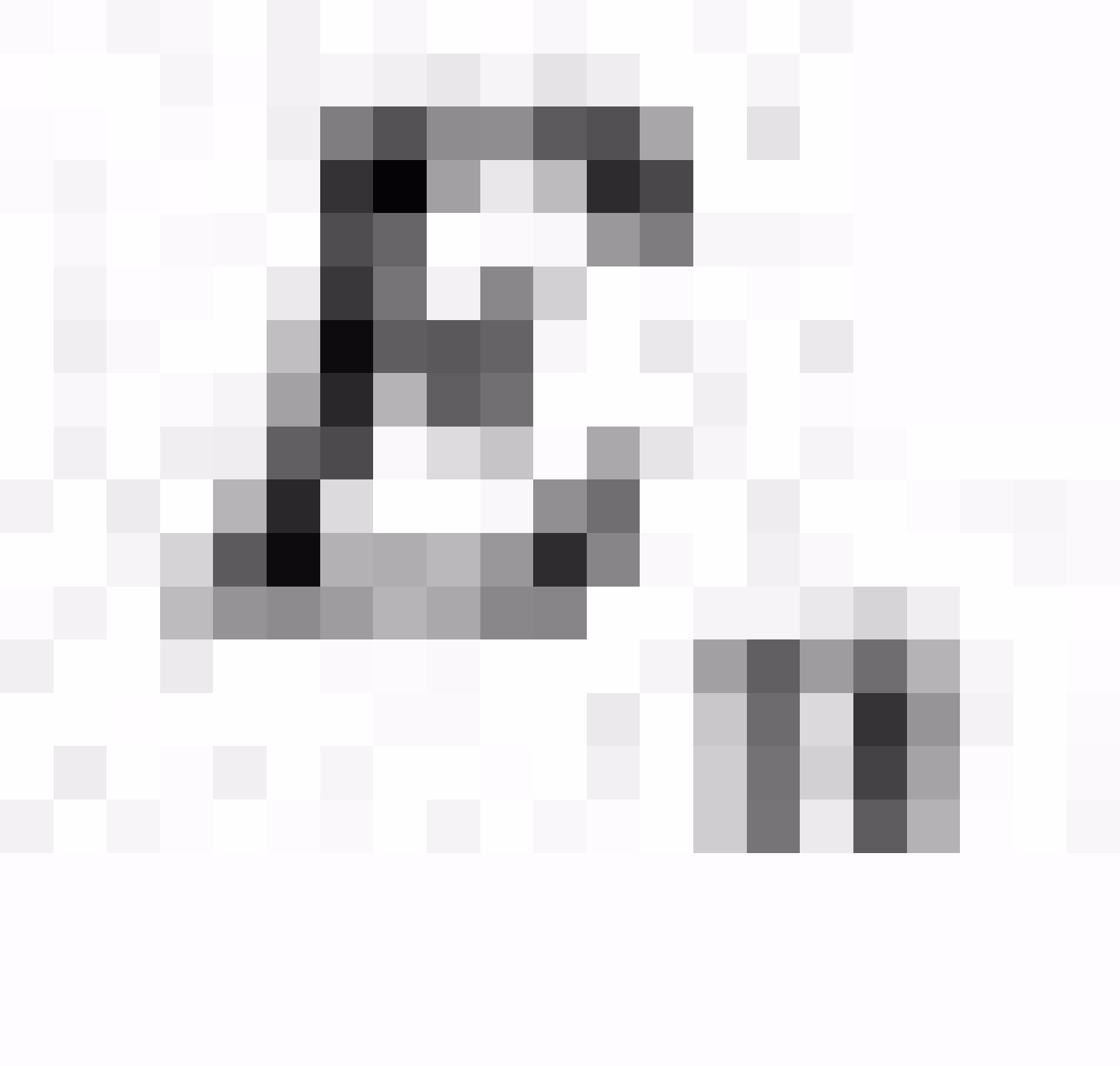

$$A = E_{\pi}, \quad E_{\pi} = \frac{qU}{2} = \frac{cU^2}{2} = \frac{q^2}{2c} \quad (36.8)$$

1. $\frac{1}{x^2} = x^{-2}$

2. $\frac{d}{dx} x^{-2} = -2x^{-3}$

3. $= -2x^{-3} = -\frac{2}{x^3}$

4. $= -\frac{2}{x^3}$





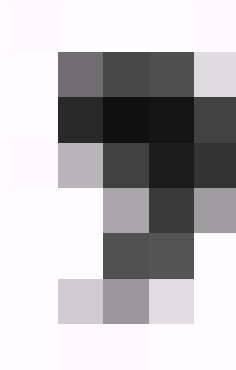
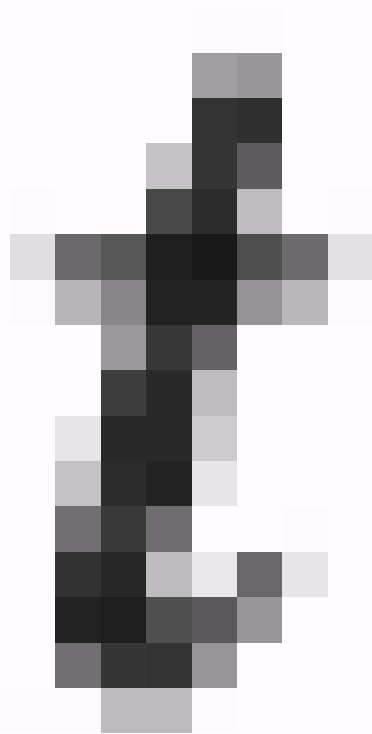
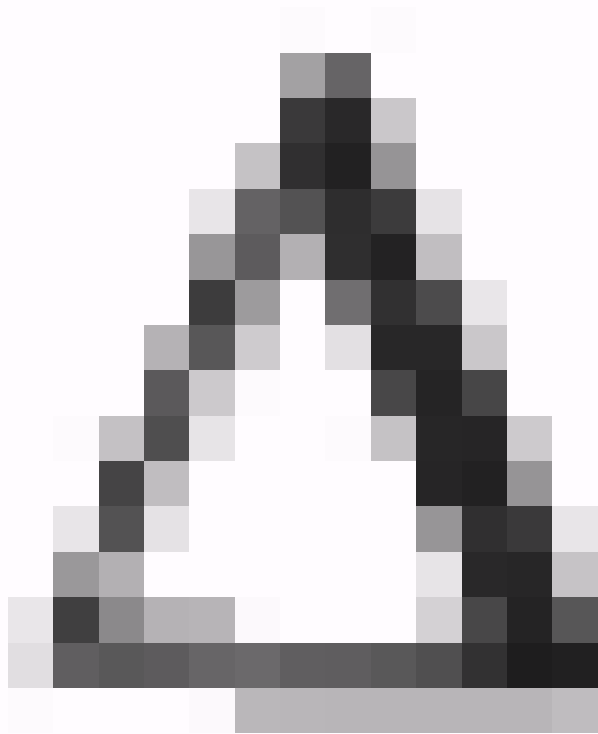

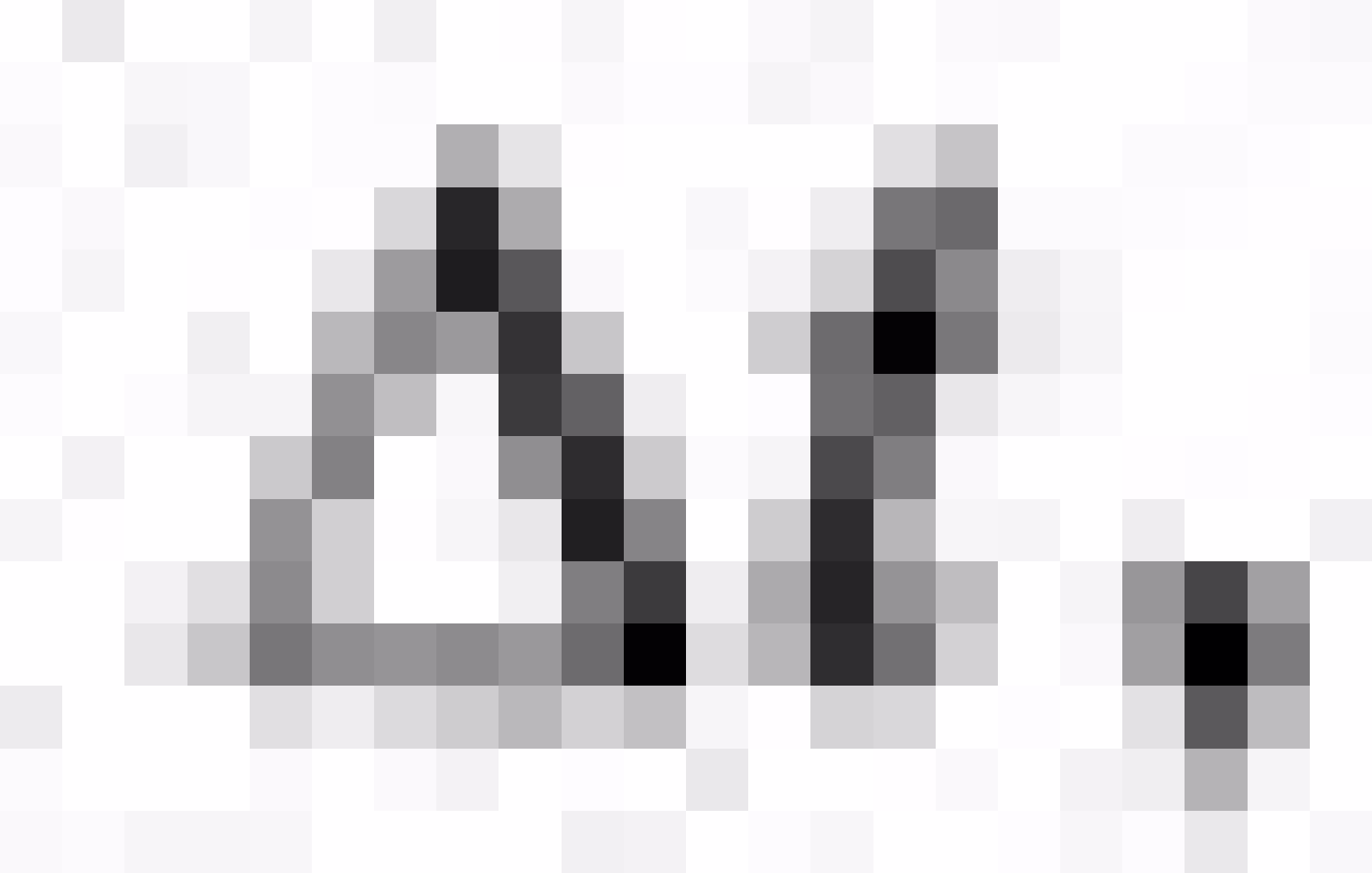

$$I = \frac{\Delta q}{\Delta t} \quad (37.1)$$

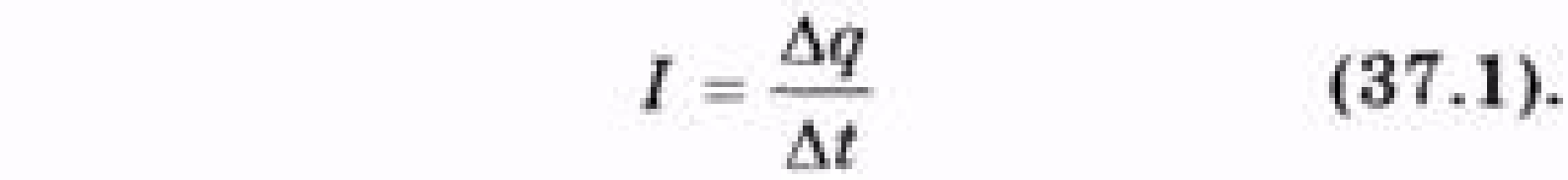

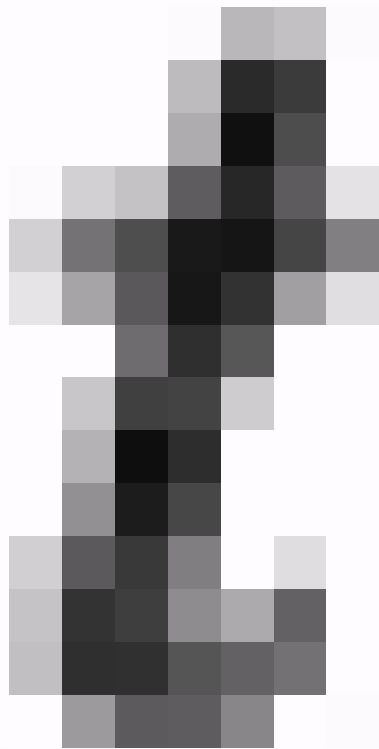
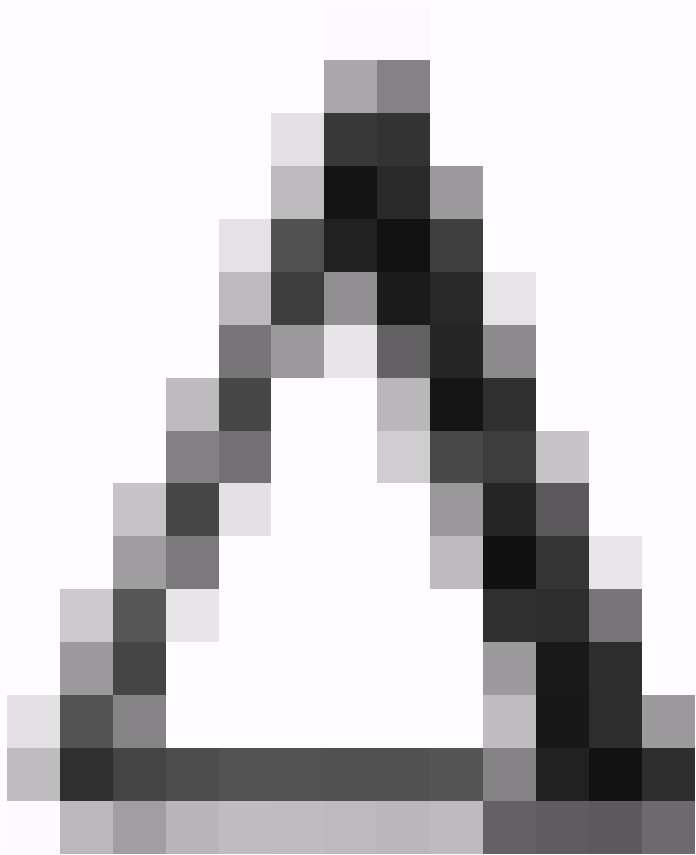

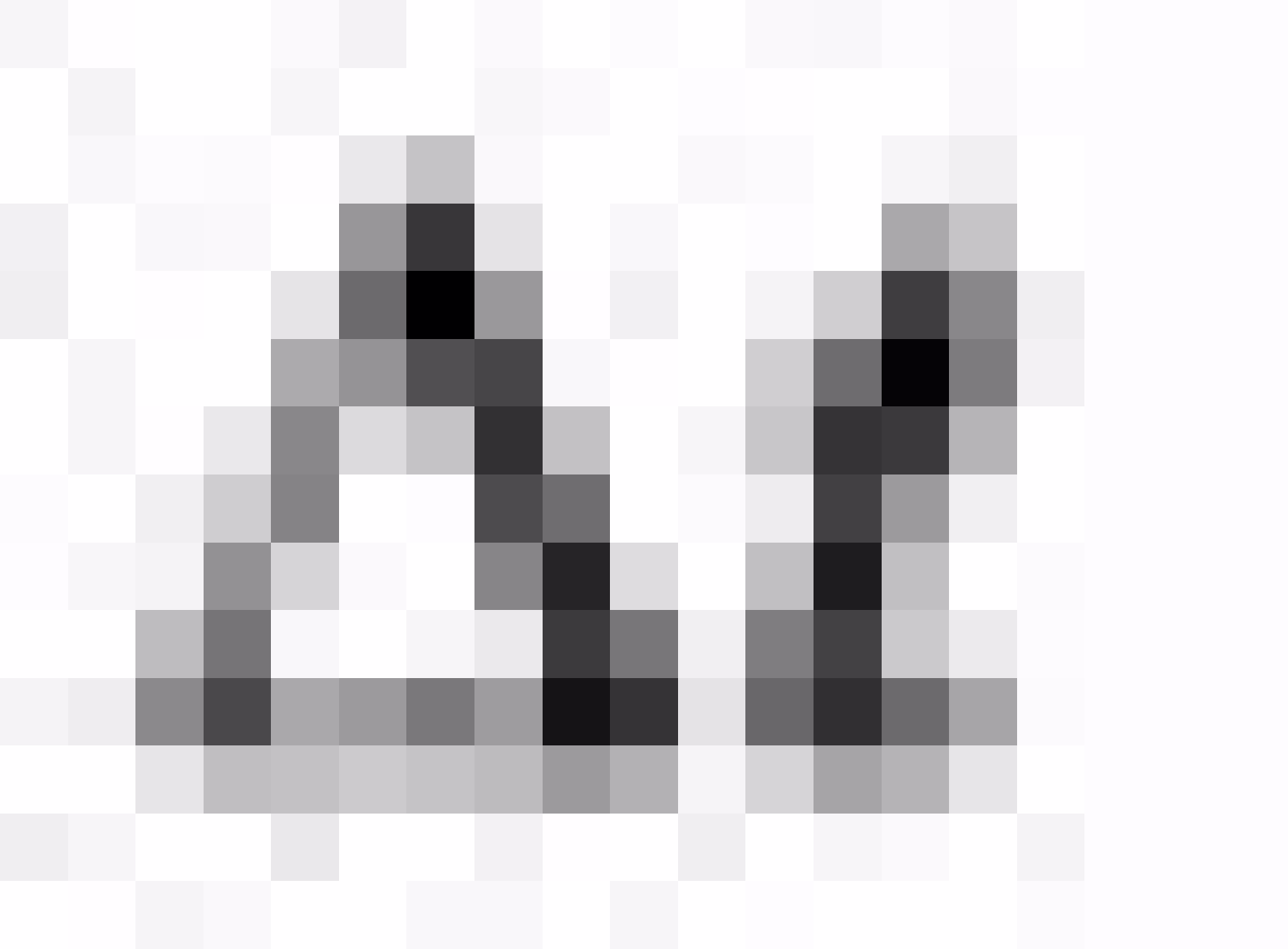

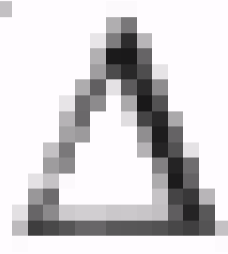
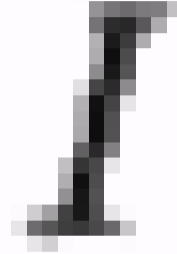
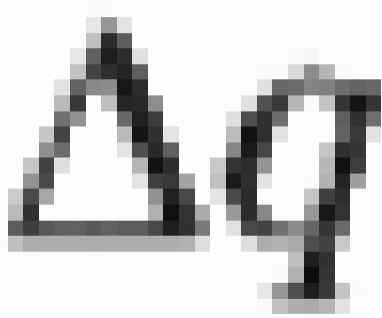

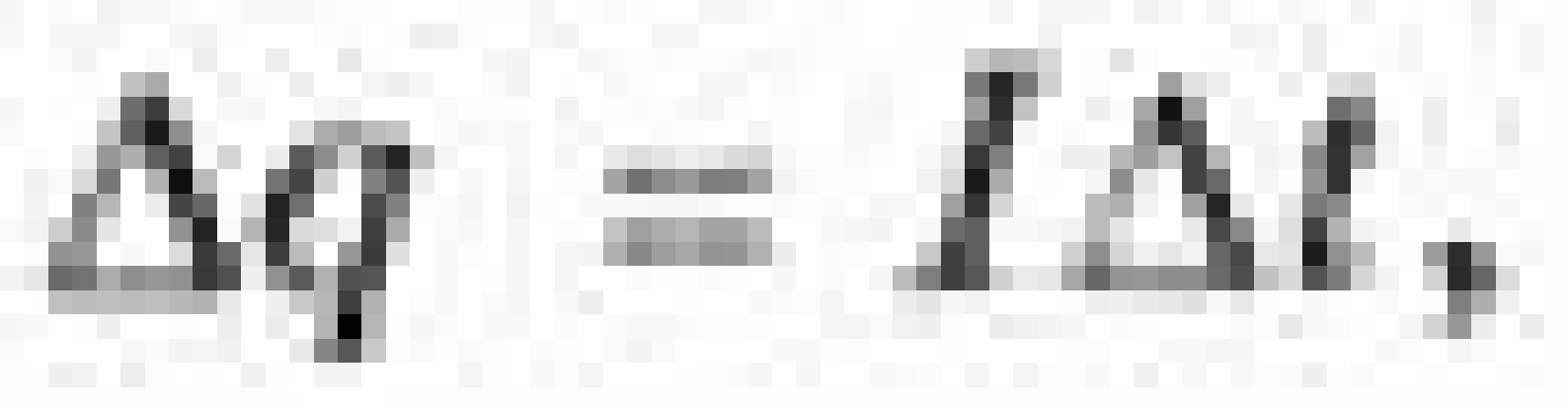

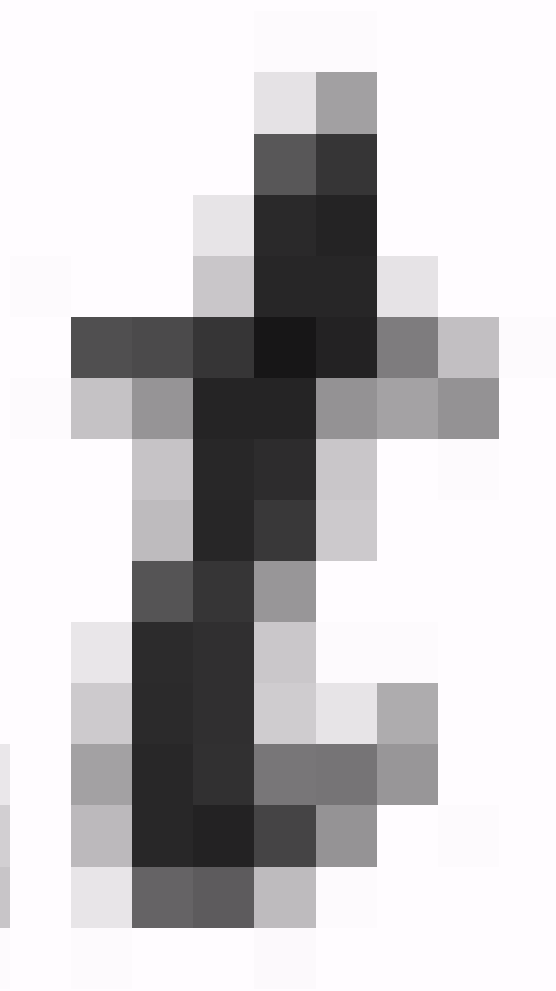
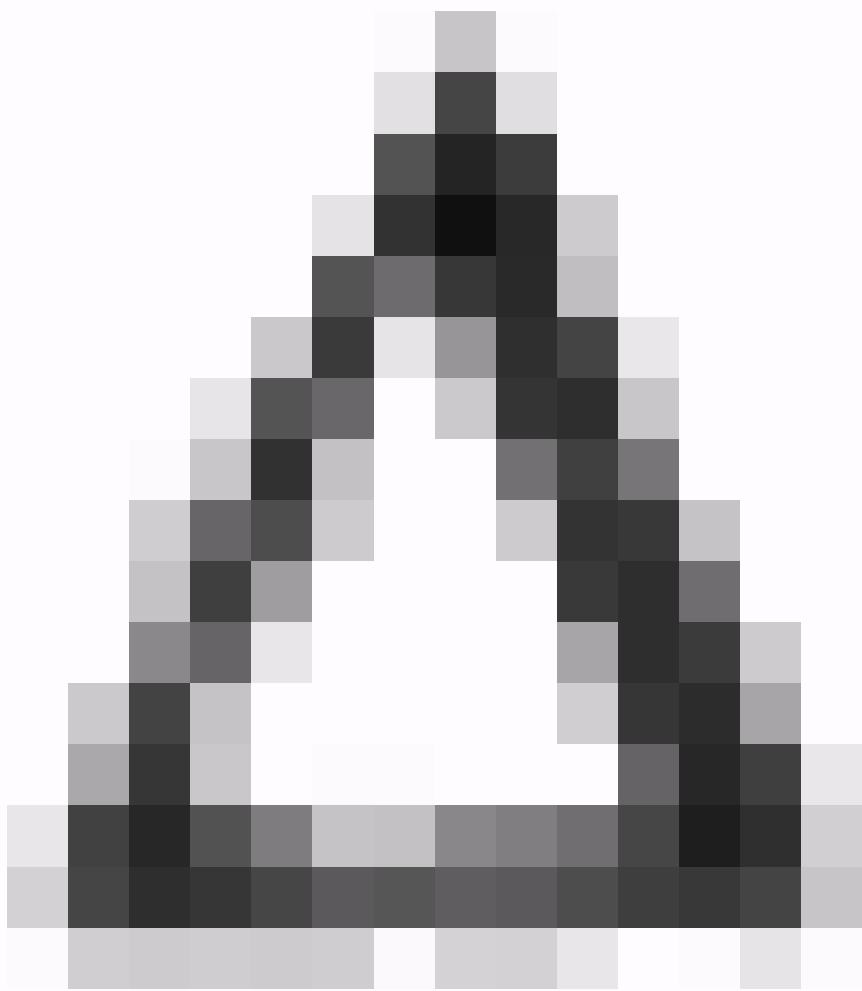

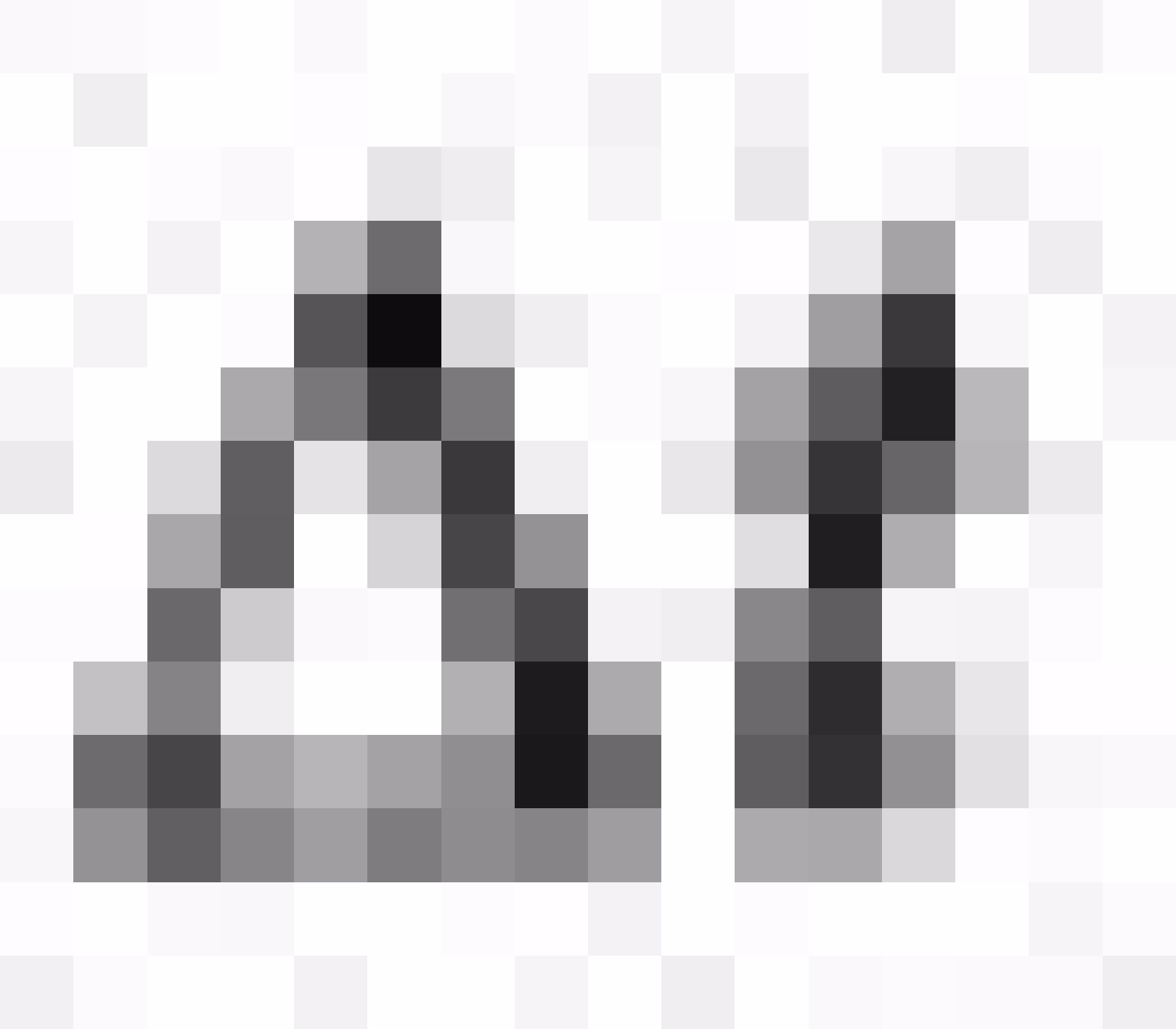

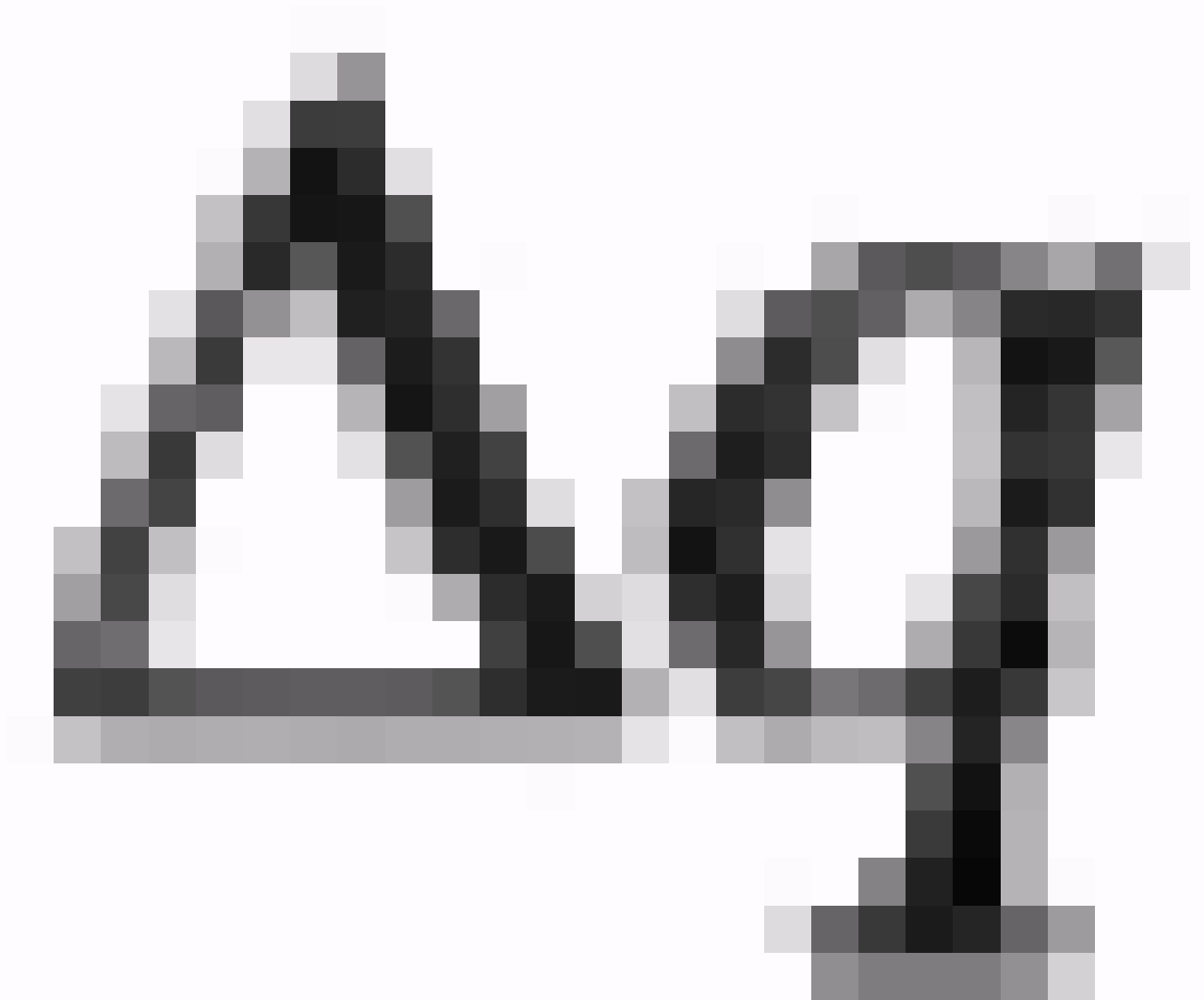

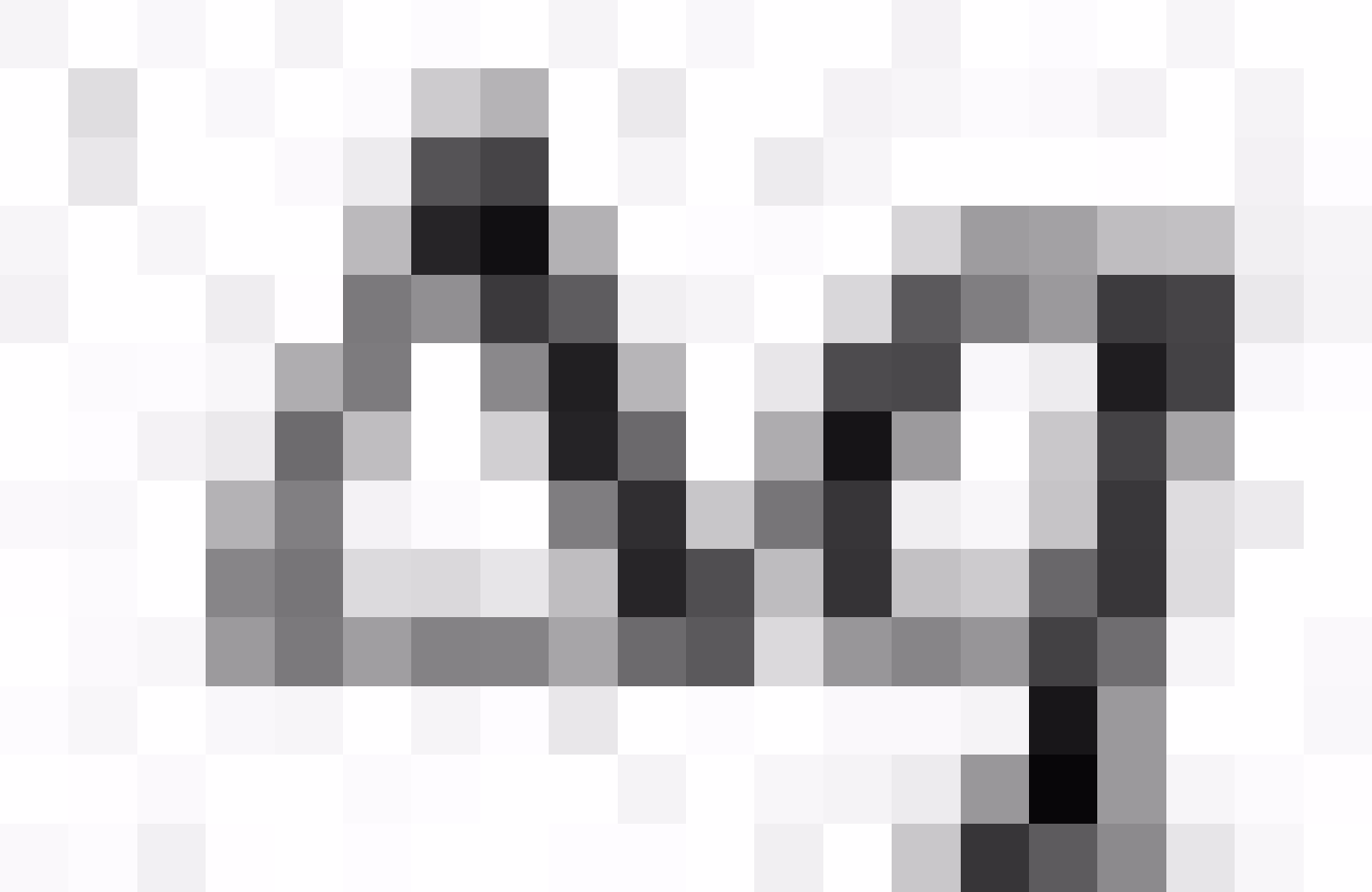

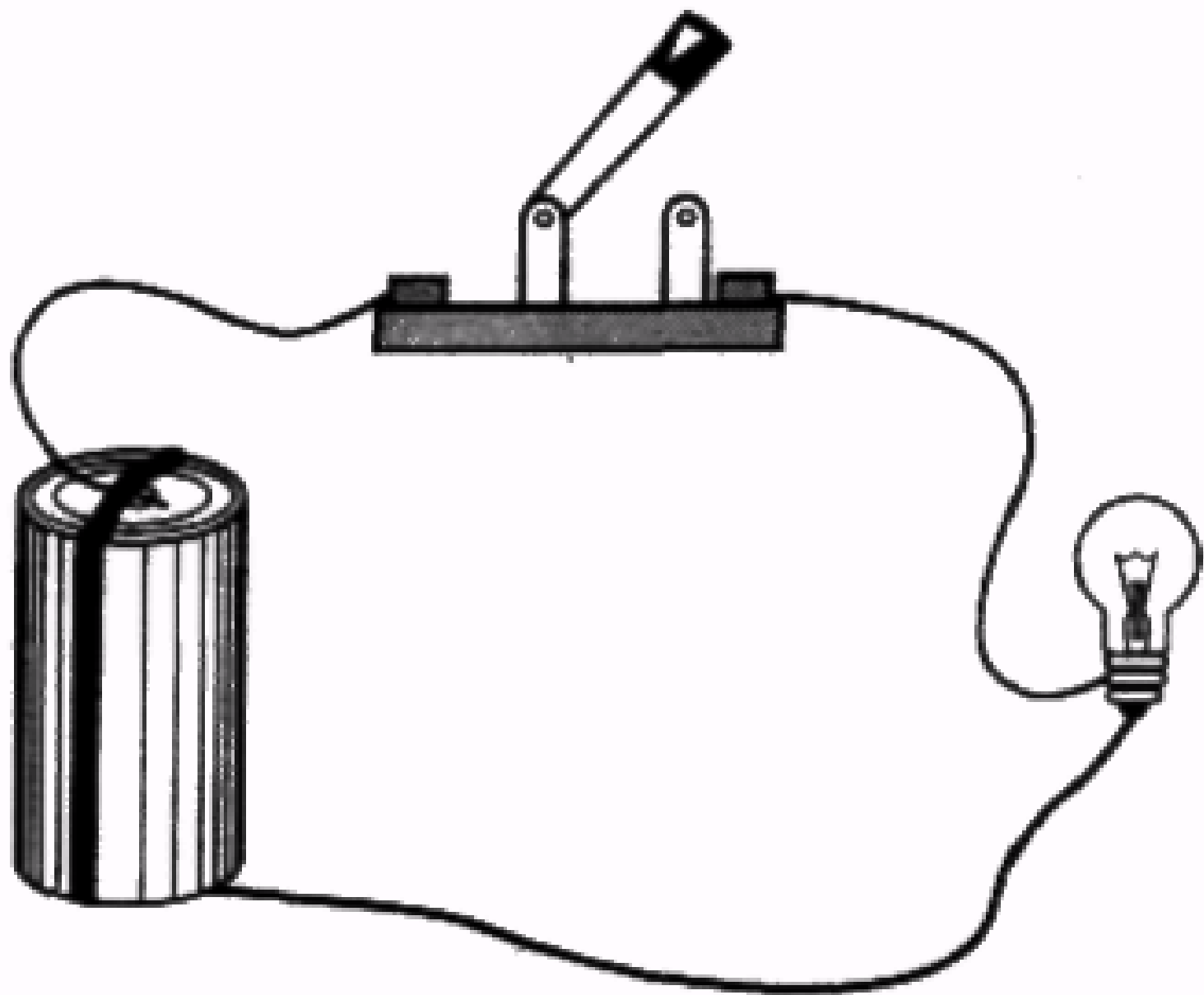

Мал. 2.116

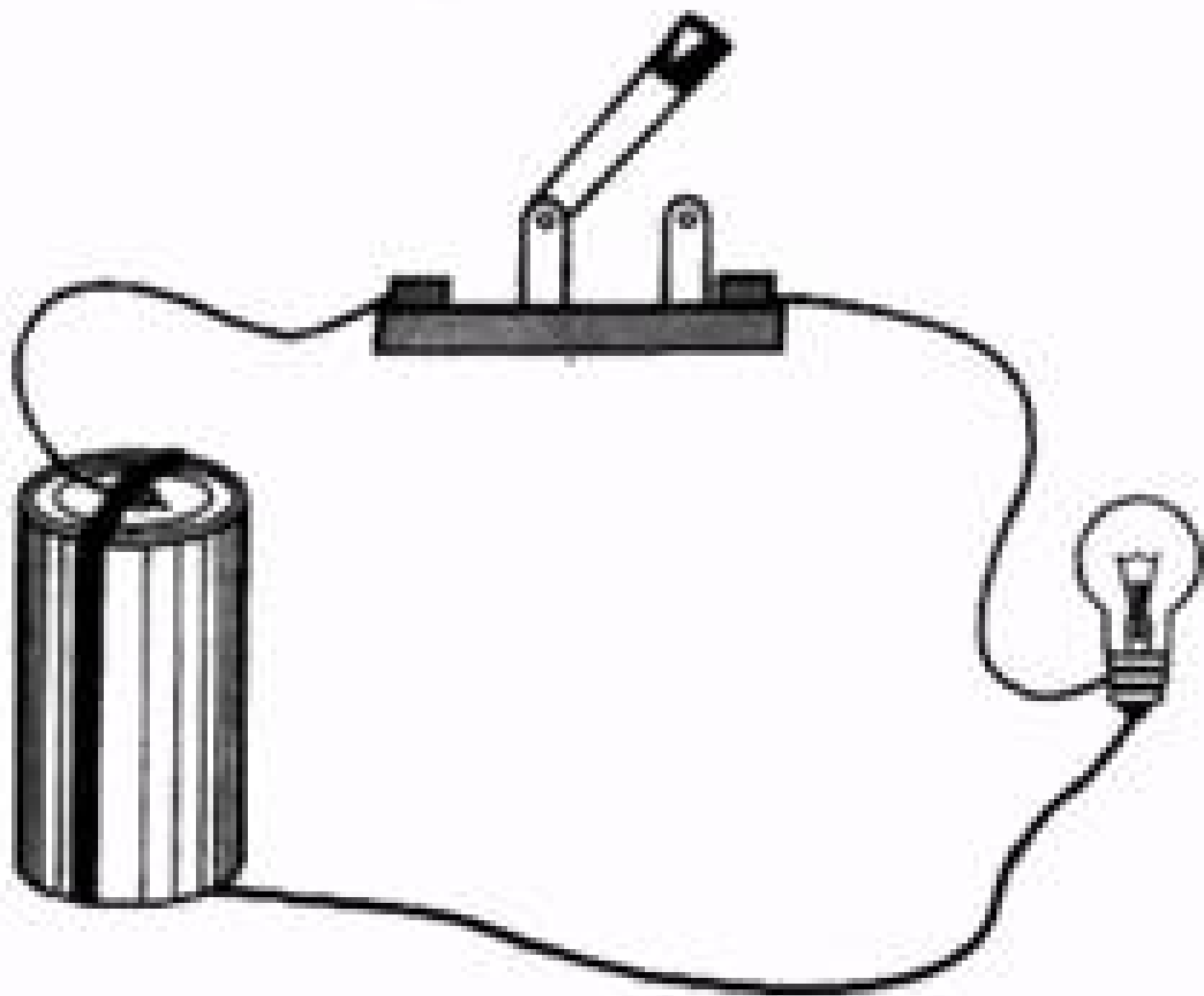

Мал. 2.116

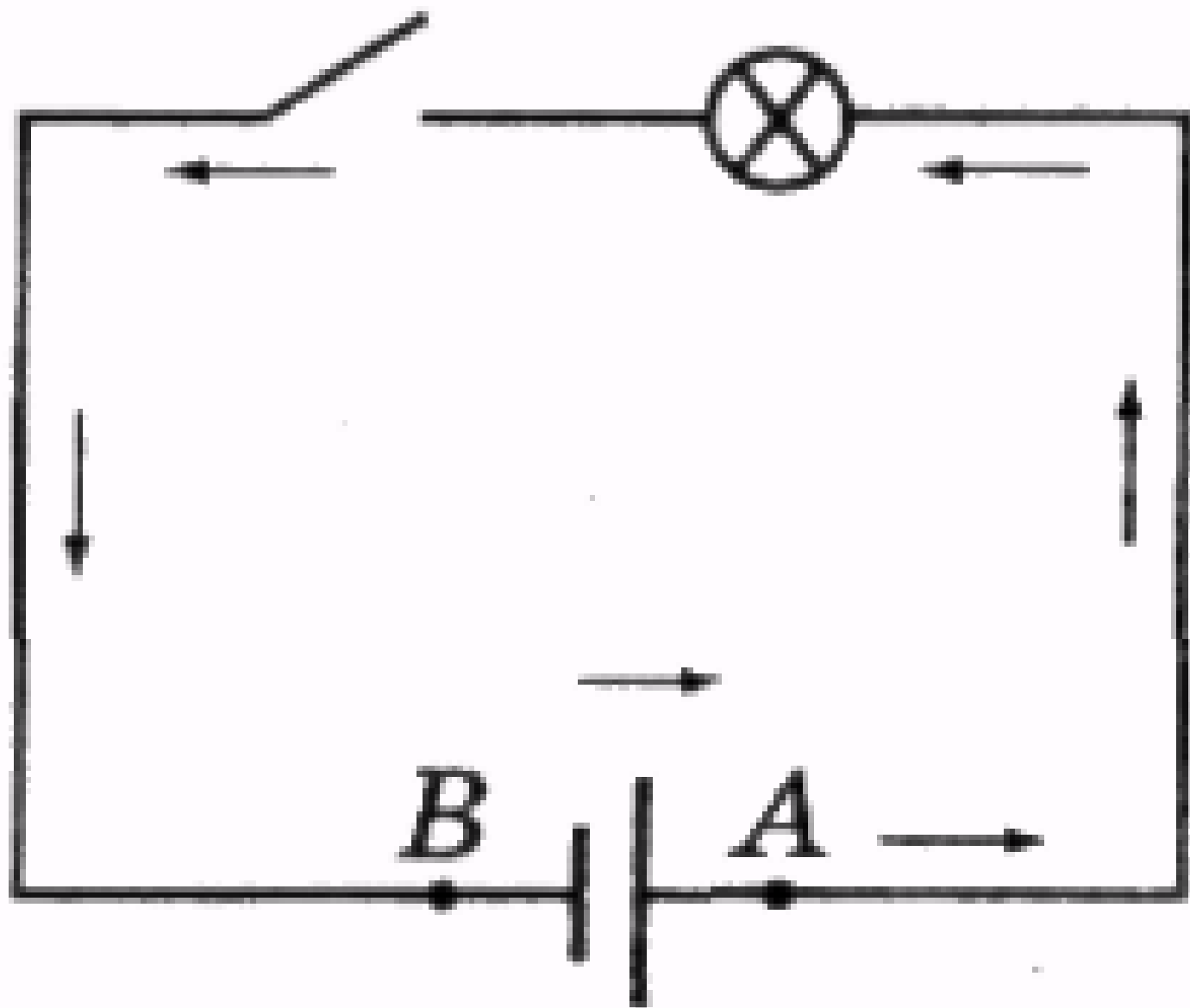

Мал. 2.117

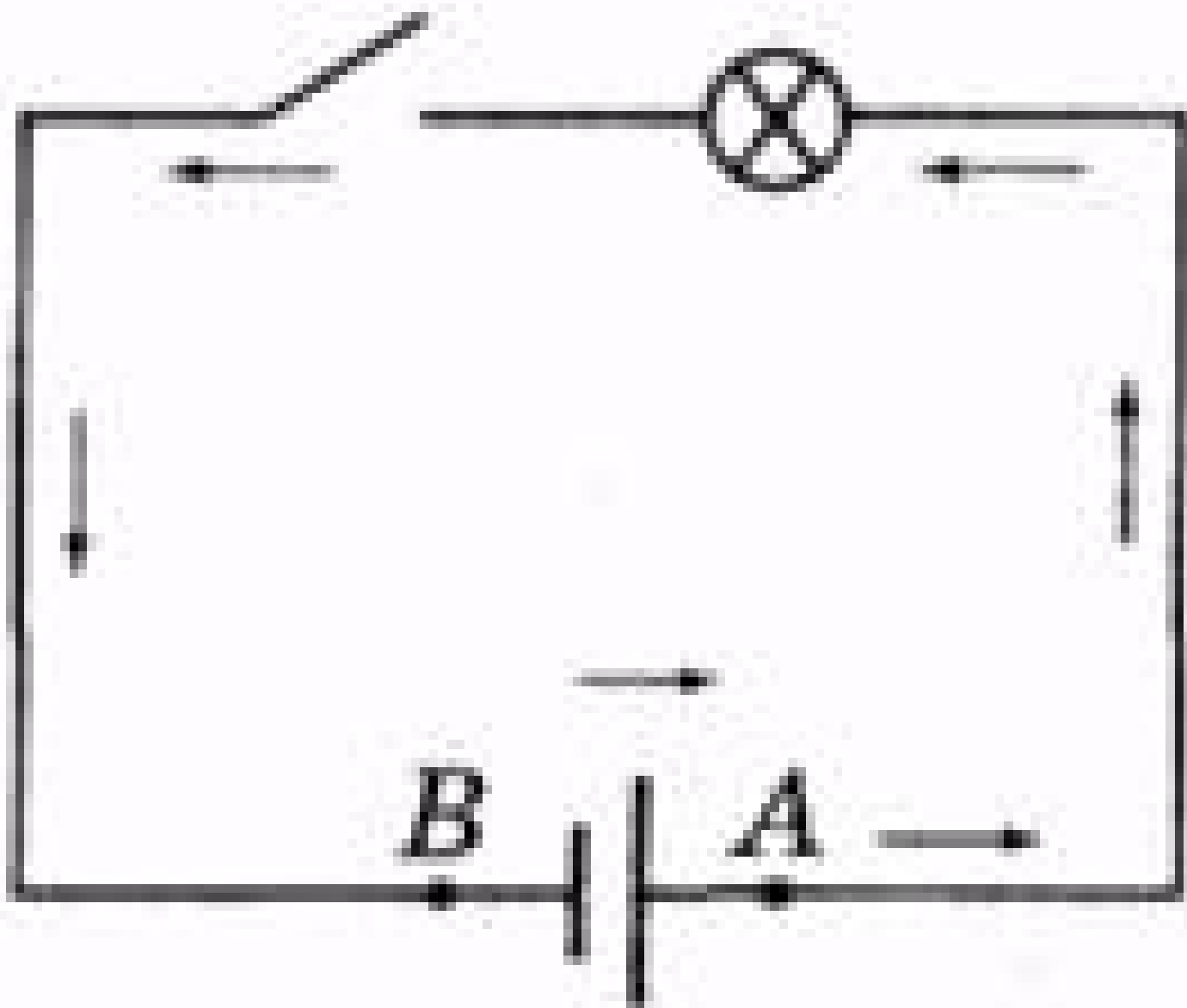

Mar. 2.117

| | |
|---|----------------------|
|  | гальванічний елемент |
|  | провідник |
|  | лампа розжарювання |
|  | резистор |
|  | конденсатор |
|  | катушка |
|  | ключ |
|  | вольтметр |
|  | амперметр |

Мал. 2.118

 гальванічний елемент

 провідник

 лампа розжарювання

 резистор

 конденсатор

 котушка

 ключ

 вольтметр

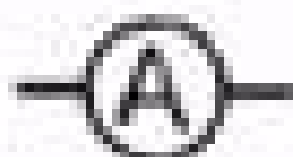
 амперметр

Мал. 2.118

$$R = \frac{V}{I} \quad (37.2)$$



10M

=

1B

.

1A

1000

—

—

1000

1000

1

$$R = \rho \frac{L}{S}$$

(37.3)



10731

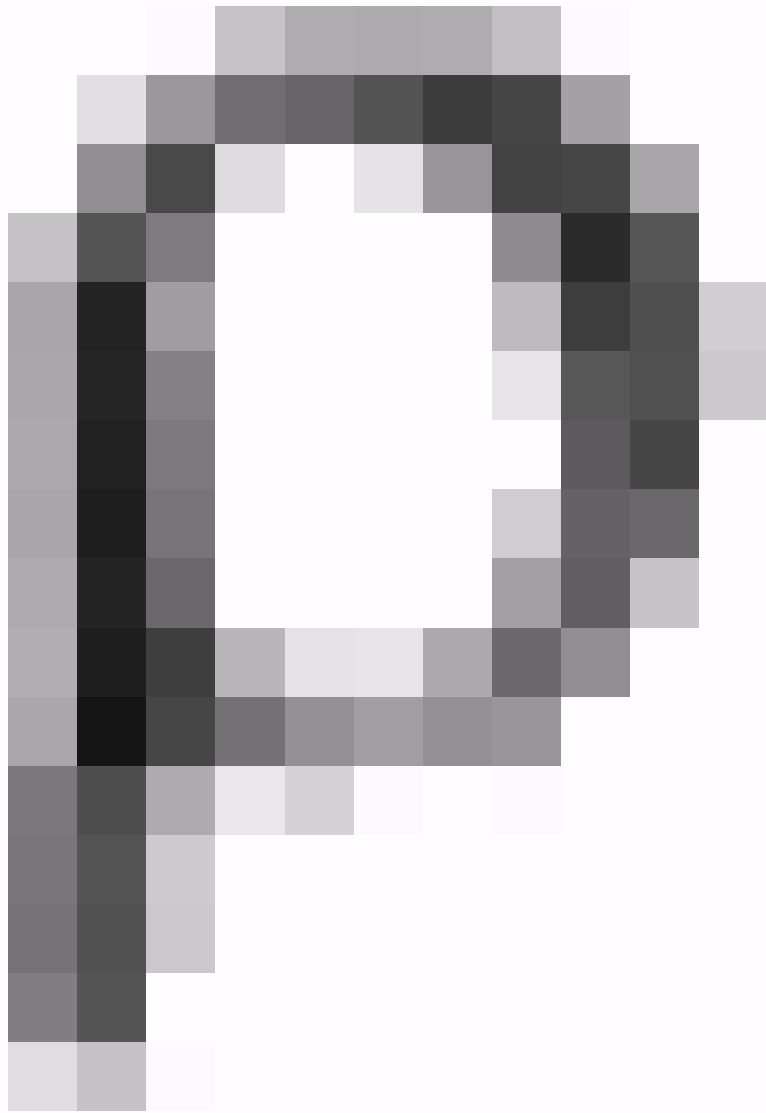

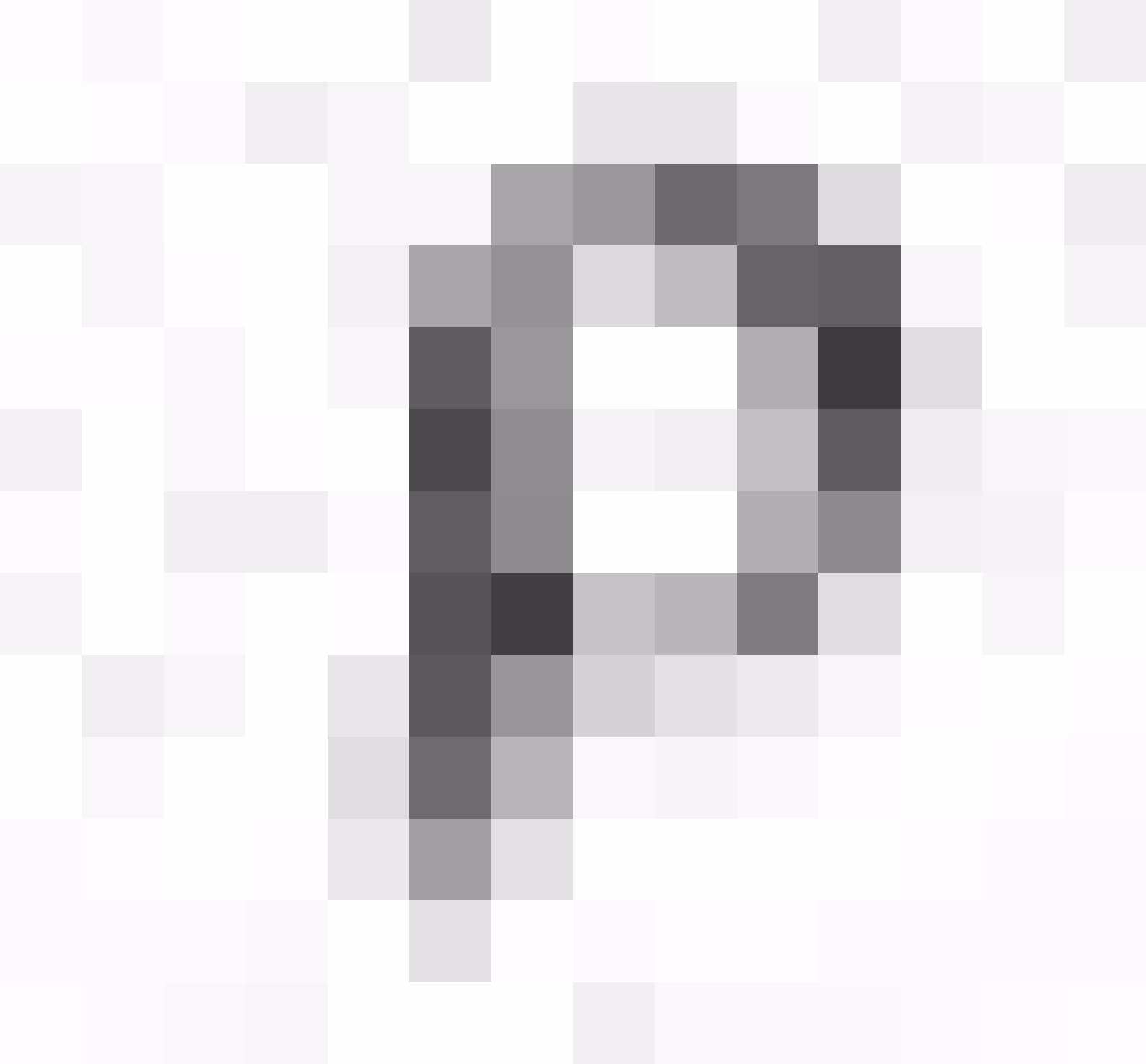

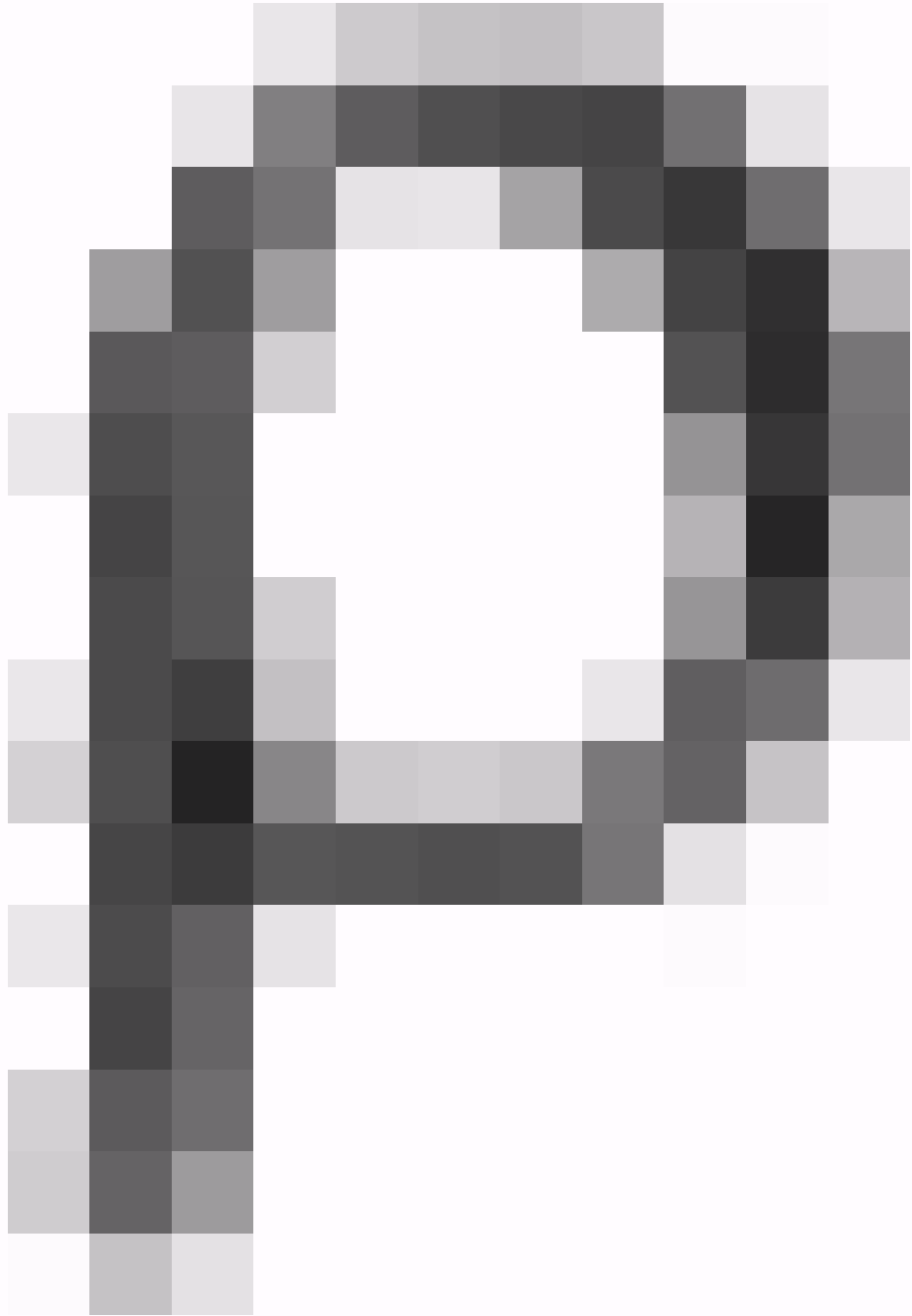



$$I = \frac{U}{R} \quad (37.4)$$

11

12

13

14

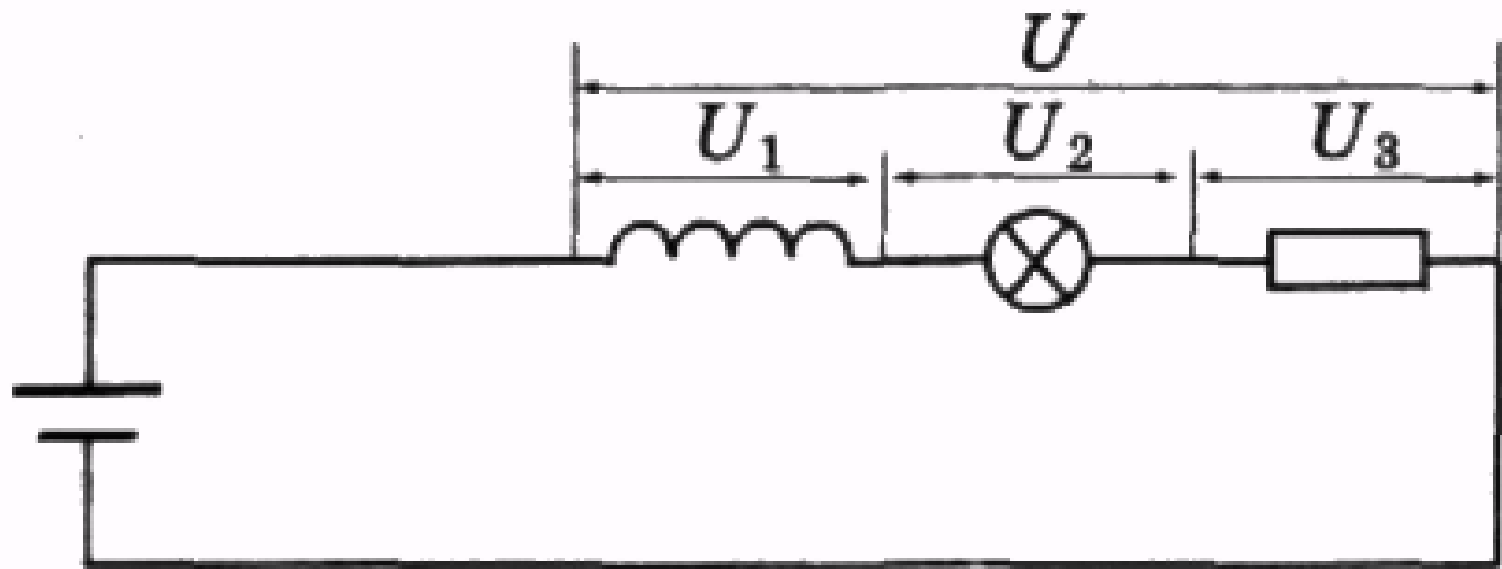

Мал. 2.119

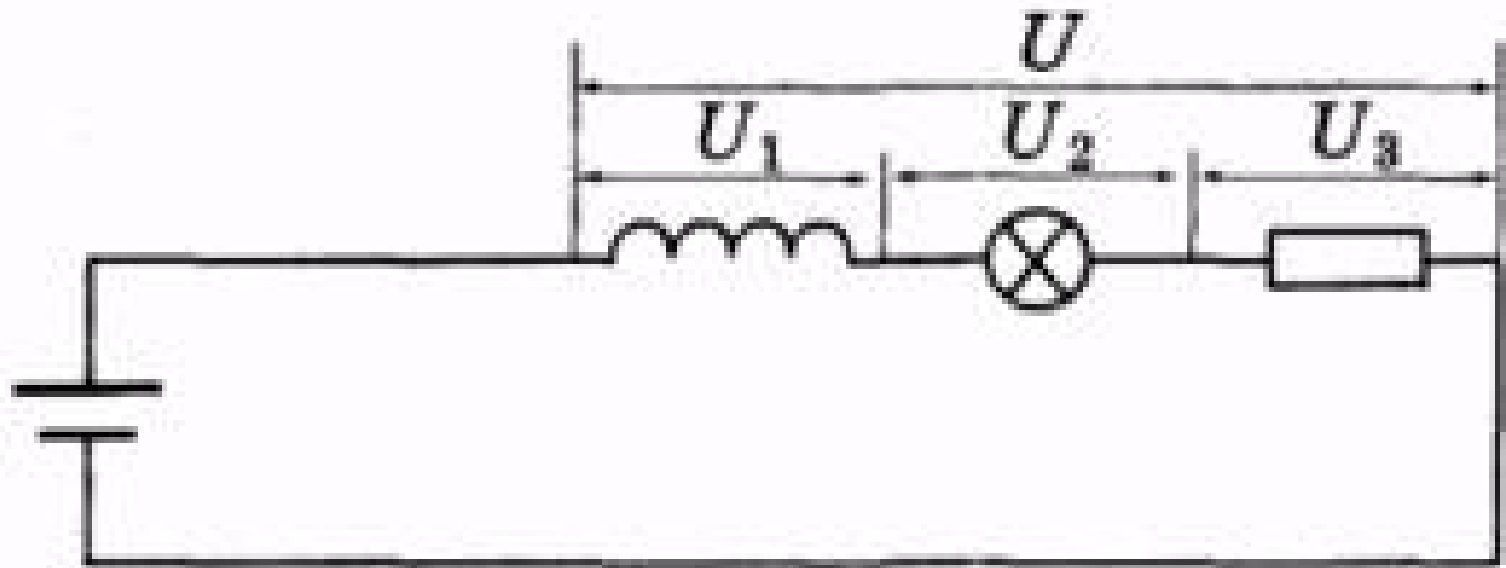

Мал. 2.119

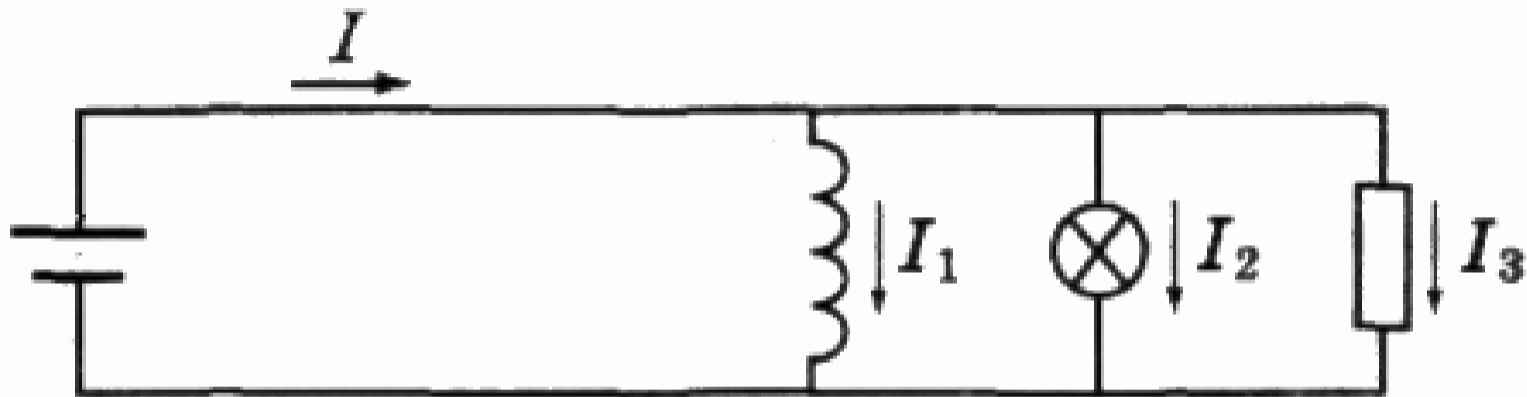

Мал. 2.120

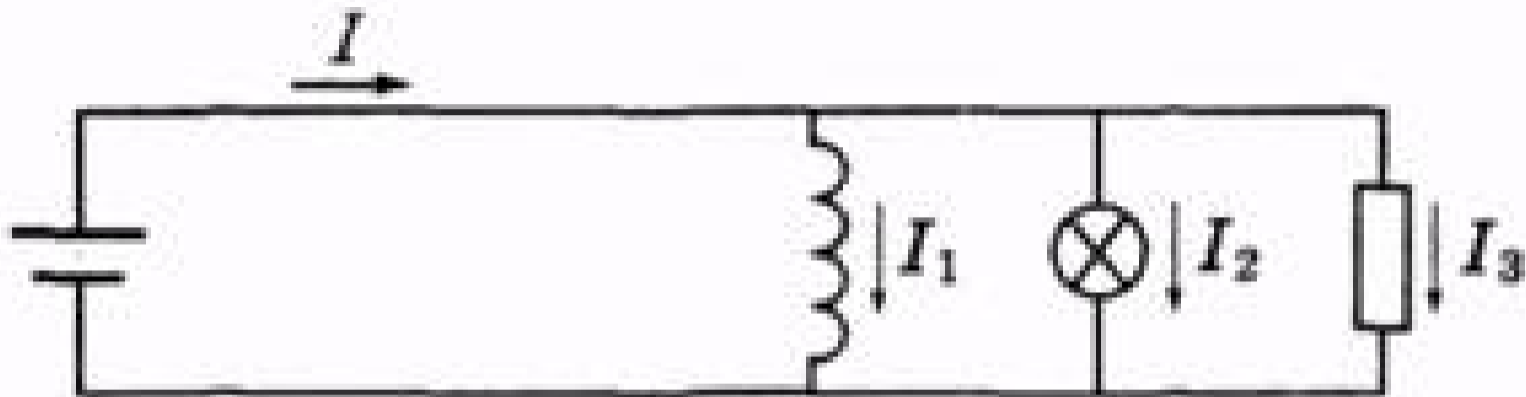

Мал. 2.120

$$V = V_1 + V_2 + V_3 = IR_1 + IR_2 + IR_3 = I(R_1 + R_2 + R_3).$$

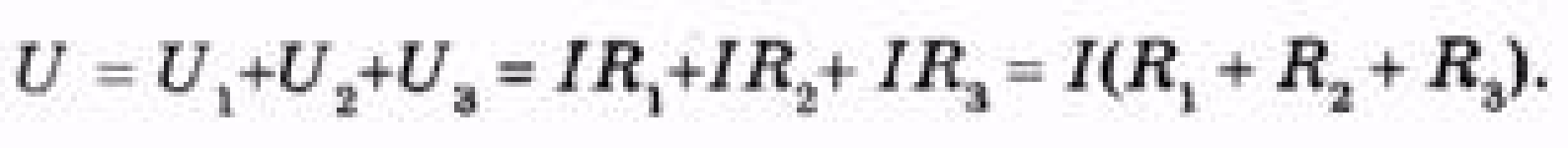

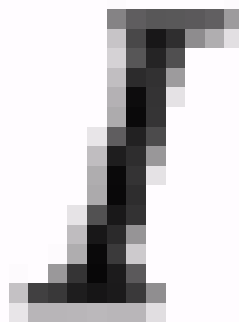
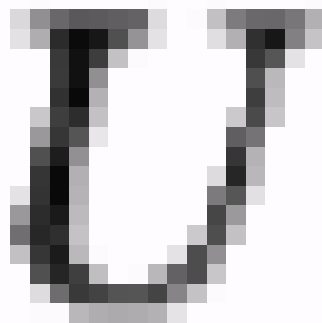
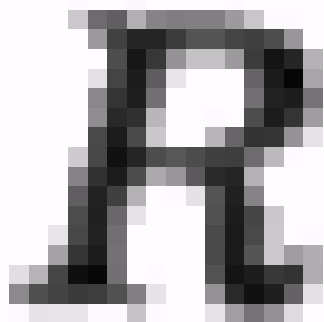

17

18

19

20

21

$R = R_1 + R_2 + R_3$
 (37.5)

THE UNIVERSITY OF CHICAGO
LIBRARY

$$I = I_1 + I_2 + I_3 = \frac{U}{R_1} + \frac{U}{R_2} + \frac{U}{R_3} .$$

1. The first part of the document discusses the importance of maintaining accurate records of all transactions. This is essential for ensuring the integrity of the financial statements and for providing a clear audit trail. The second part of the document outlines the various methods used to collect and analyze data, including interviews, surveys, and focus groups. The third part of the document describes the results of the research, highlighting the key findings and the implications for practice. The fourth part of the document discusses the limitations of the study and the need for further research. The fifth part of the document provides a conclusion and a list of references.

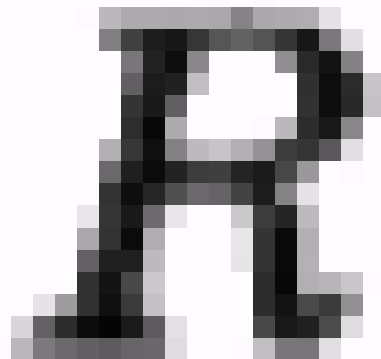
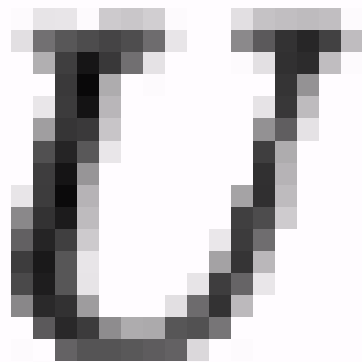
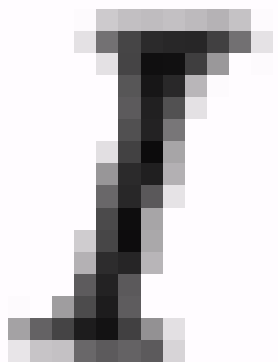

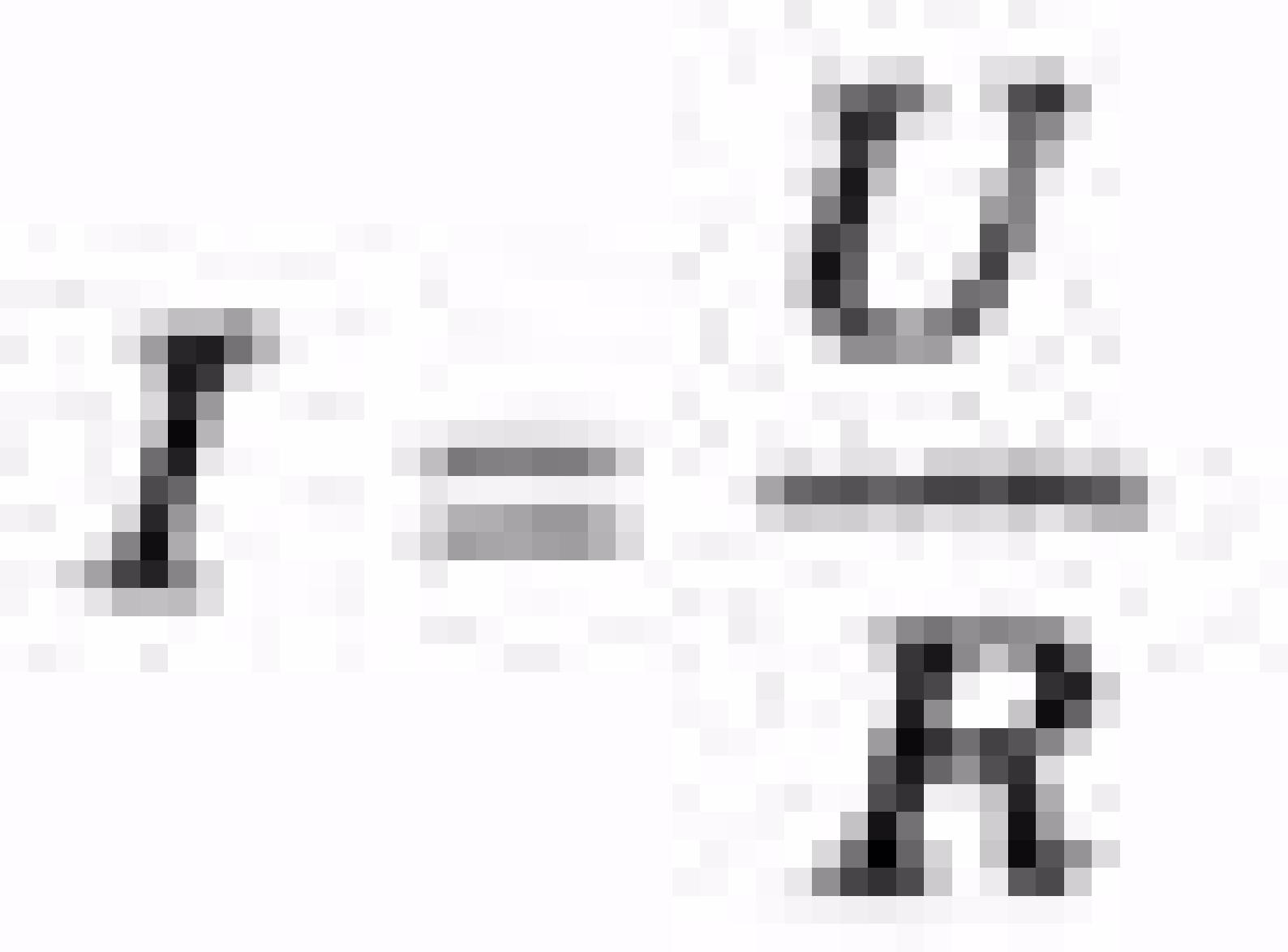

$$\frac{1}{R} = \frac{1}{R_1} + \frac{1}{R_2} + \frac{1}{R_3} \quad (37.6)$$

$$\frac{1}{R} = \frac{1}{R_1} + \frac{1}{R_2} + \frac{1}{R_3} + \frac{1}{R_4}$$

0370

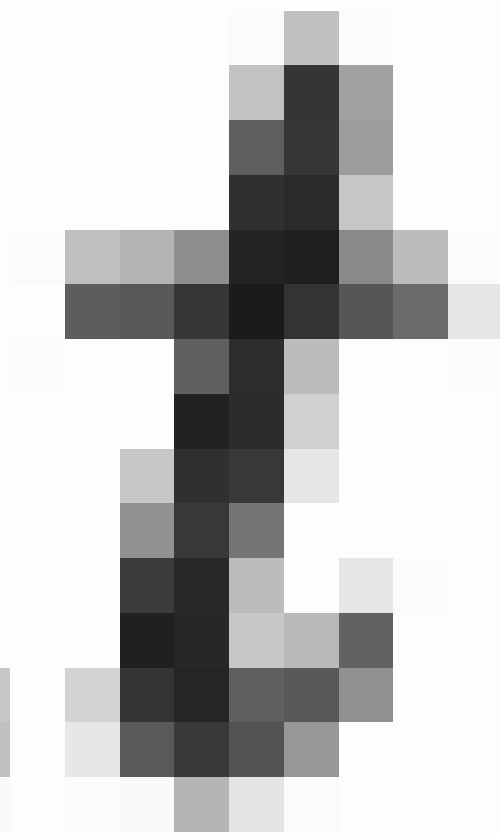
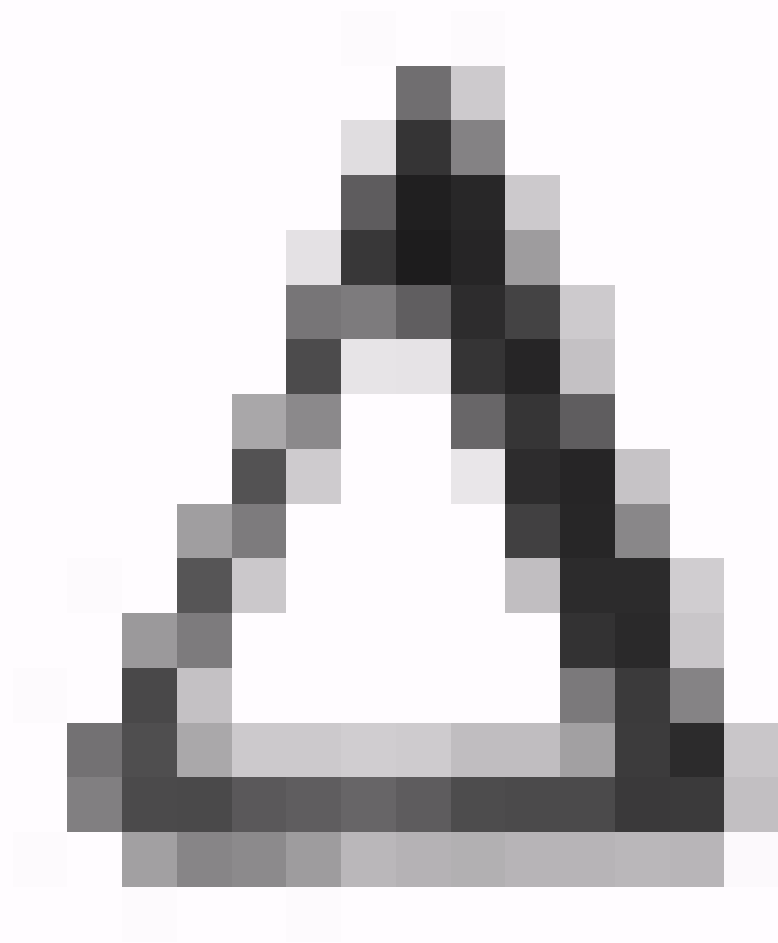

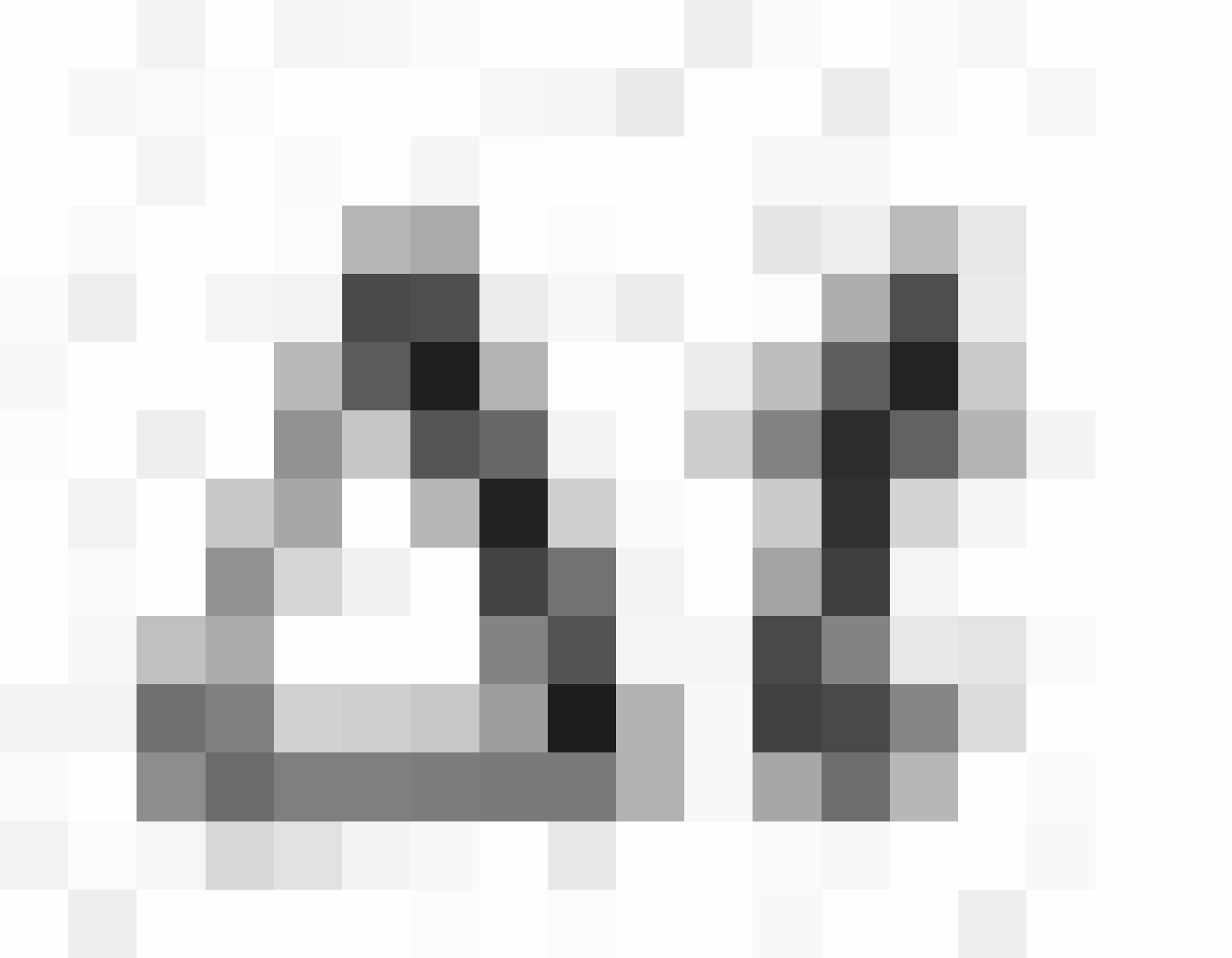

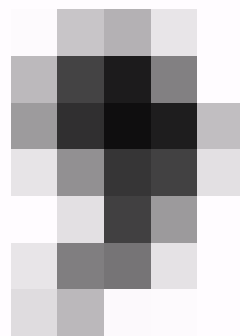
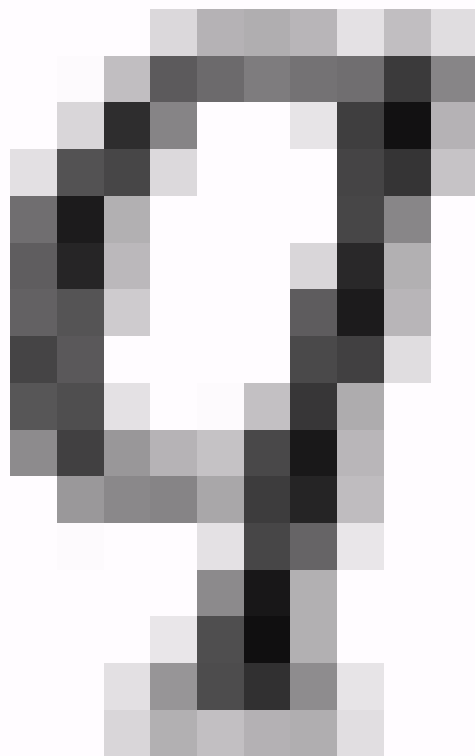
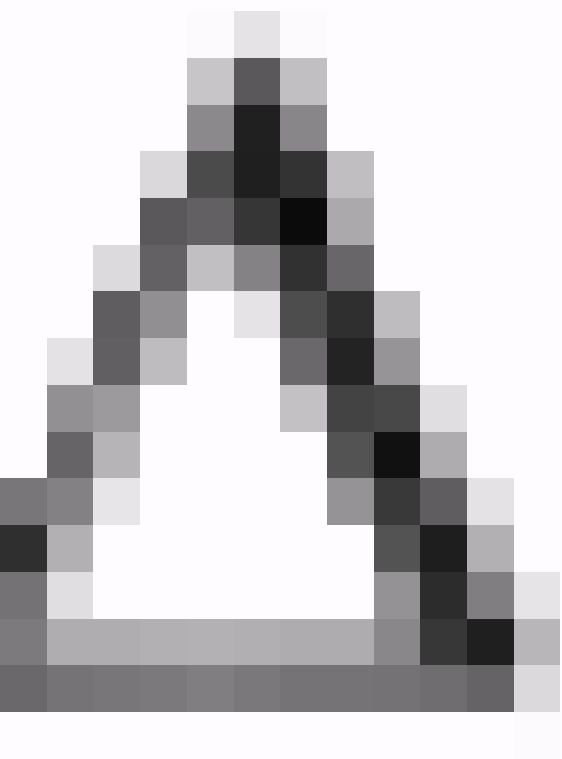

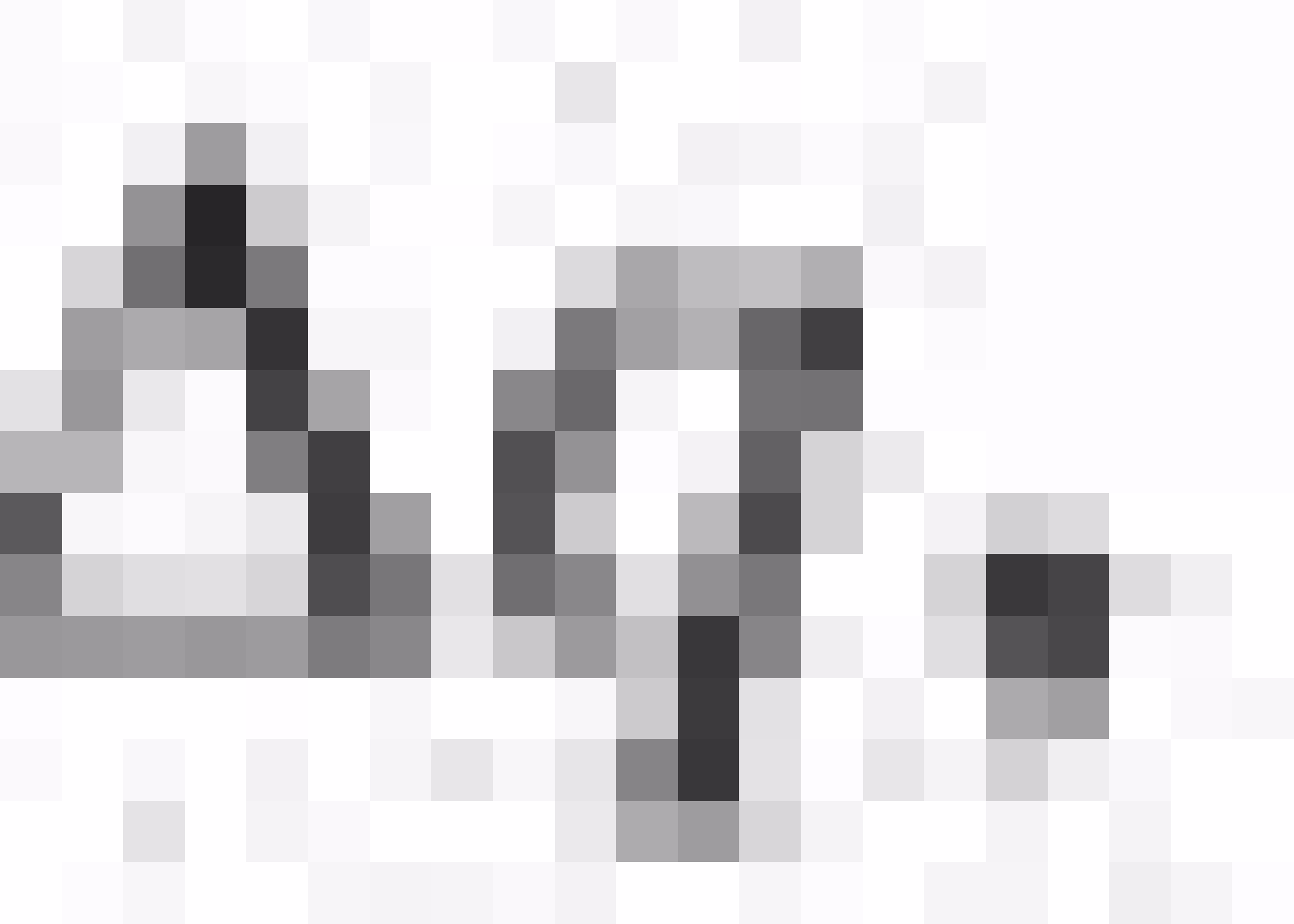

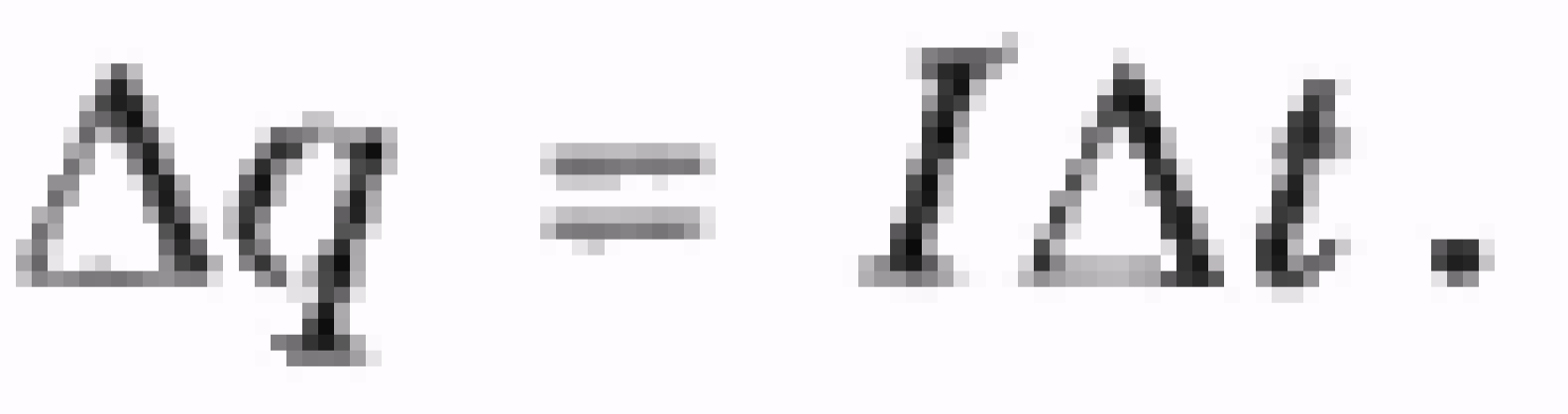

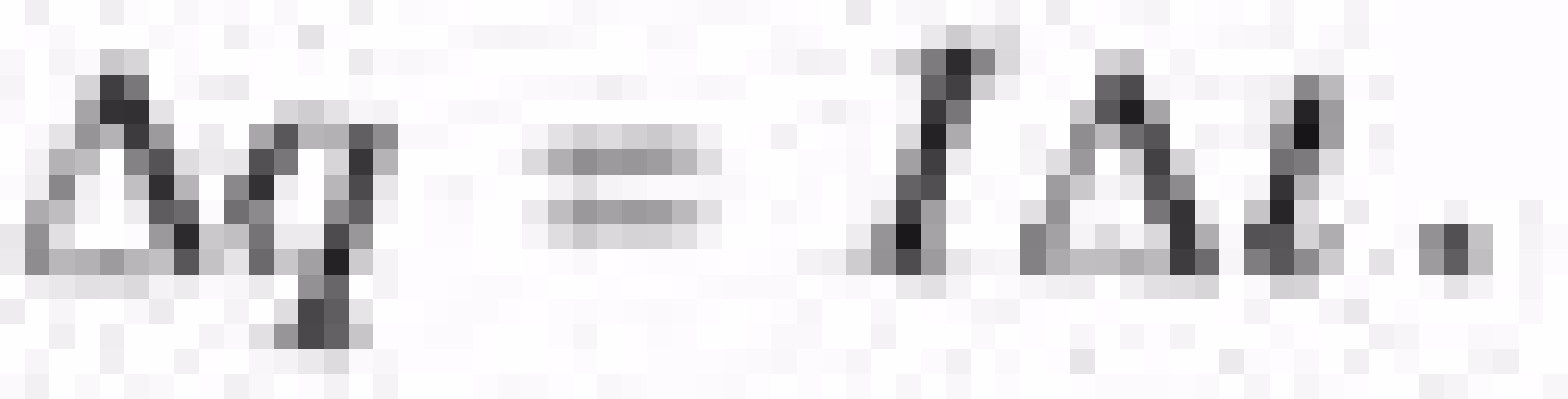

$$A = \Delta q U = I U \Delta t = \frac{U^2 \Delta t}{R} = I^2 R \Delta t \quad (37.7)$$

A

=

Q

=

I²

R₁R₂

Q₁Q₂

ALWAYS BE
SAFE

DRINK
WATER

$$P = \frac{A}{\Delta t} = I V = \frac{V^2}{R} = I^2 R \quad (37.9)$$

1. **Introduction**

The purpose of this report is to analyze the impact of the new policy on the company's performance. The data shows a significant increase in revenue and a decrease in costs, leading to a higher profit margin.

2. **Methodology**

The data was collected from the company's financial statements and analyzed using statistical methods. The results are presented in the following sections.

3. **Results**

The results show that the new policy has had a positive impact on the company's performance. The revenue has increased by 15% and the costs have decreased by 10%, resulting in a 25% increase in profit.

4. **Conclusion**

The new policy has been successful in improving the company's performance. It is recommended that the company continue to implement similar policies in the future.

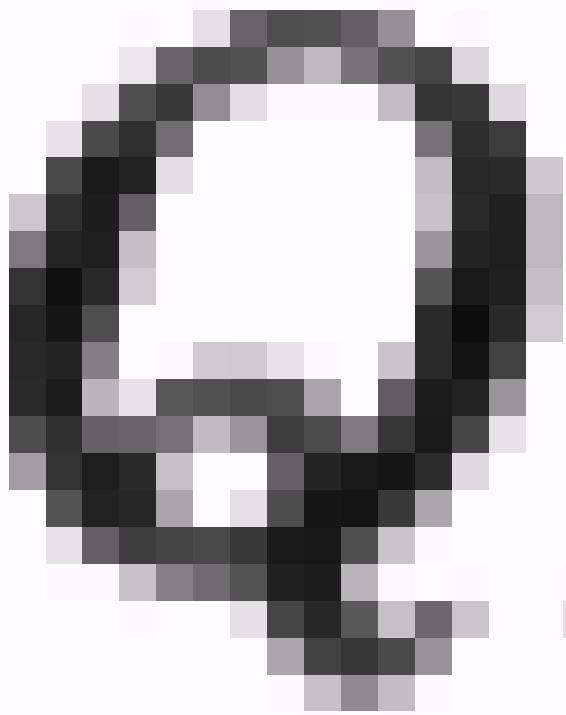

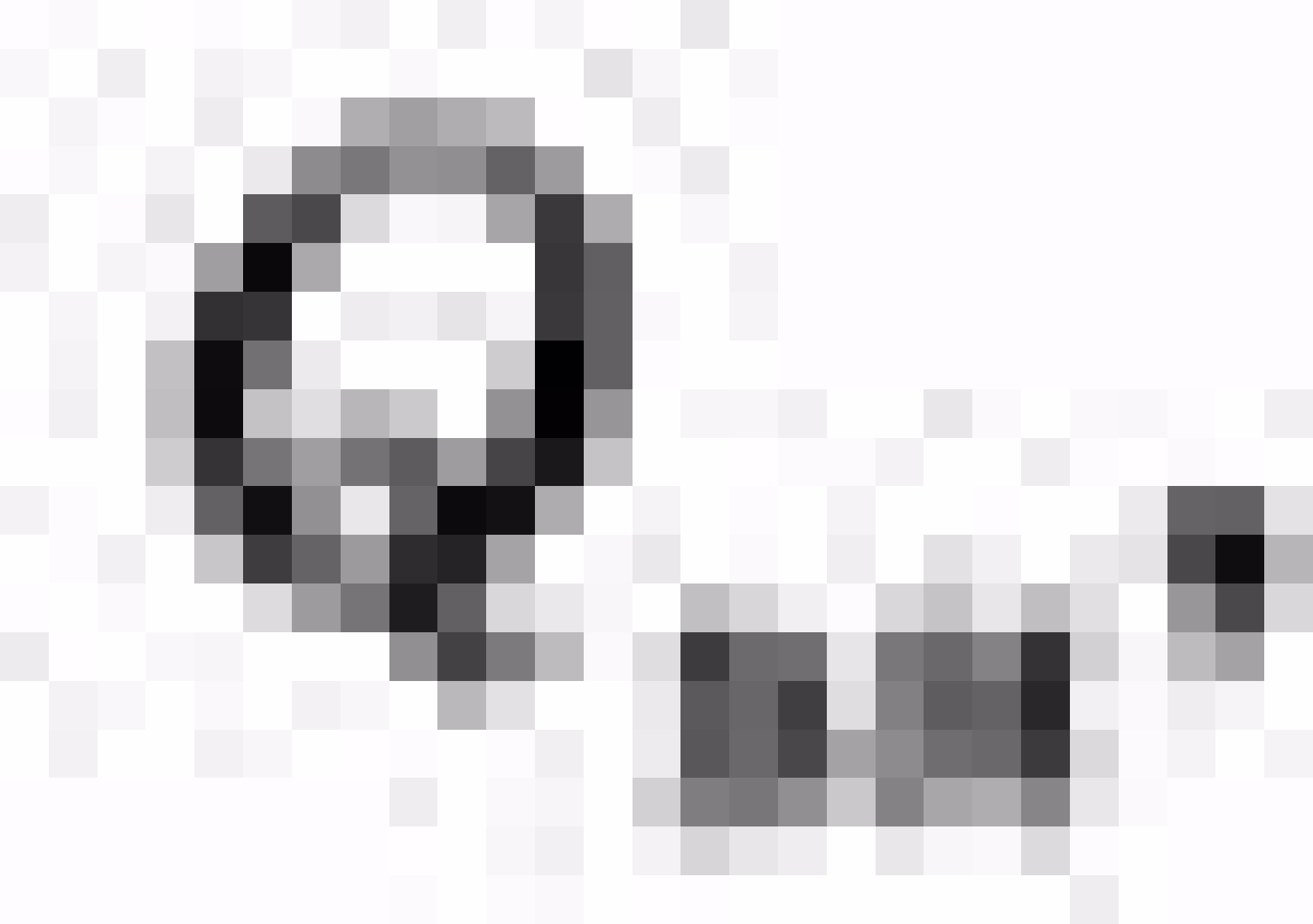

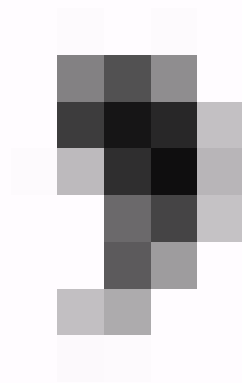
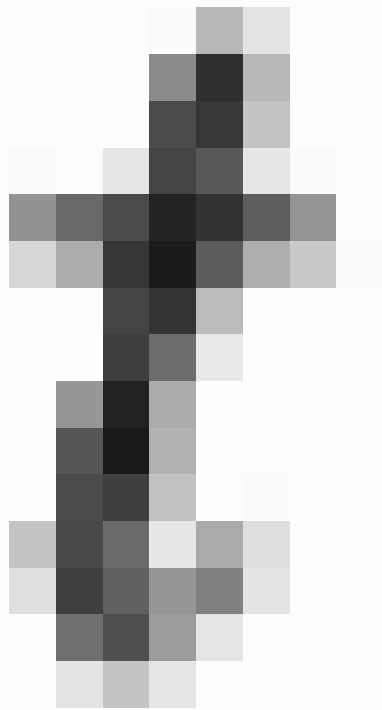
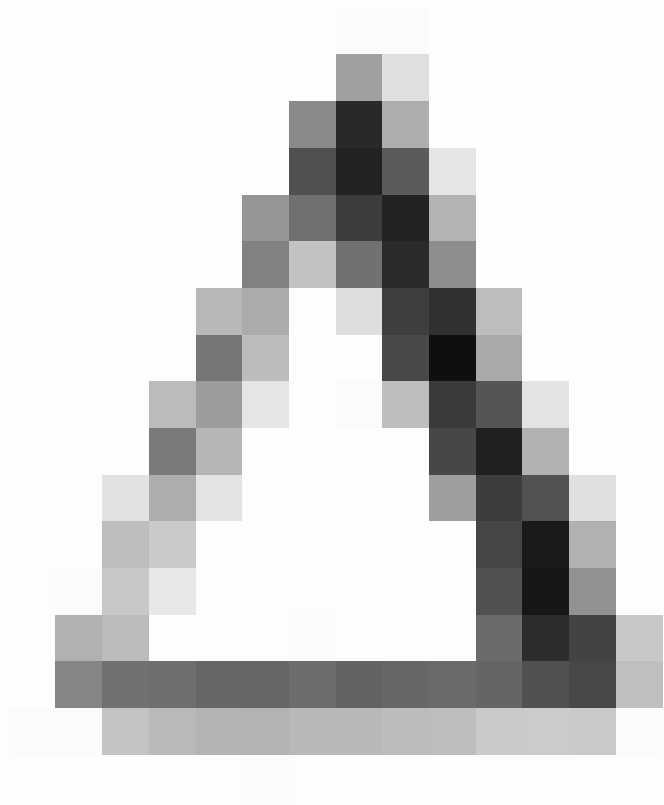

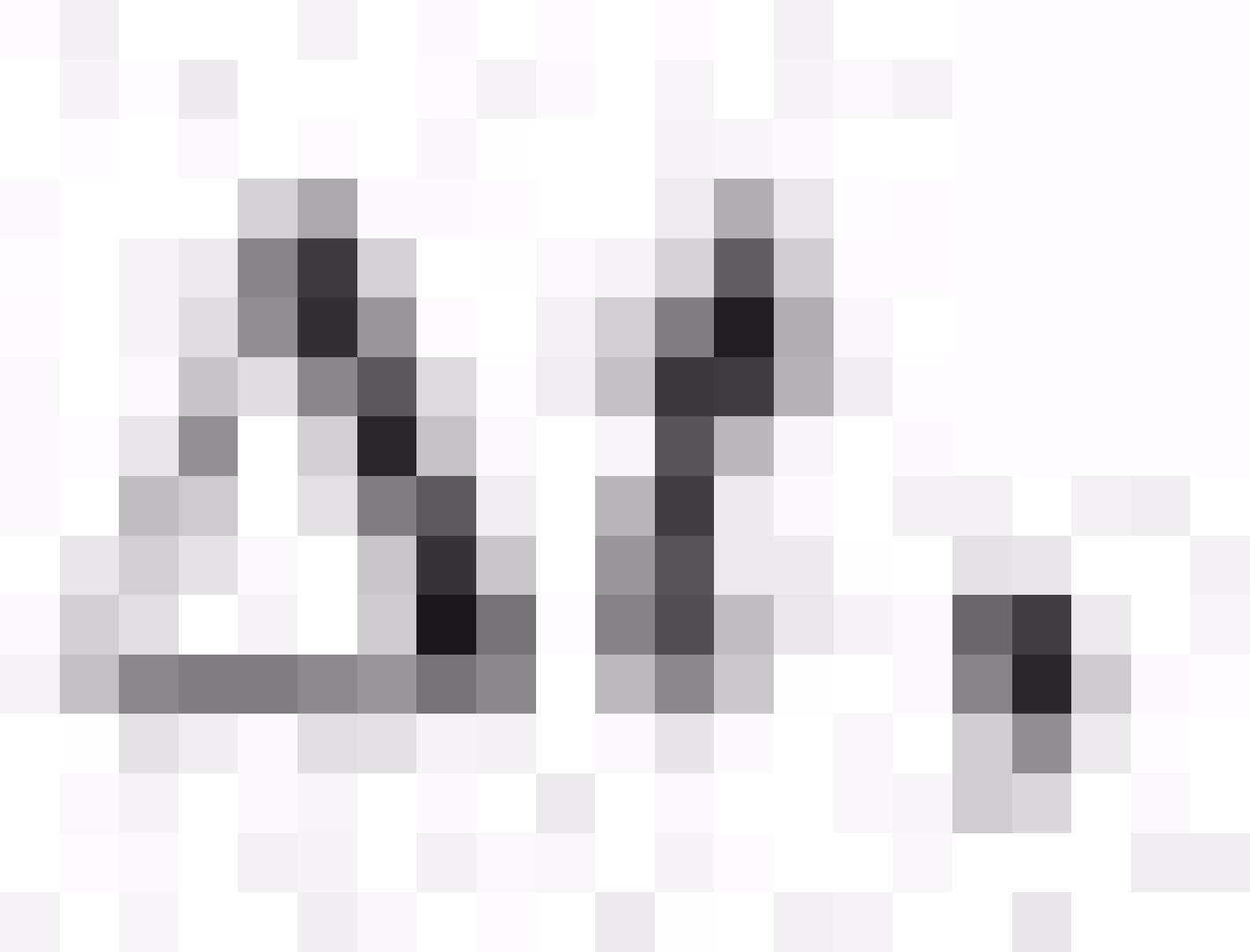

Q. A.

= 12 mt

(37.10)

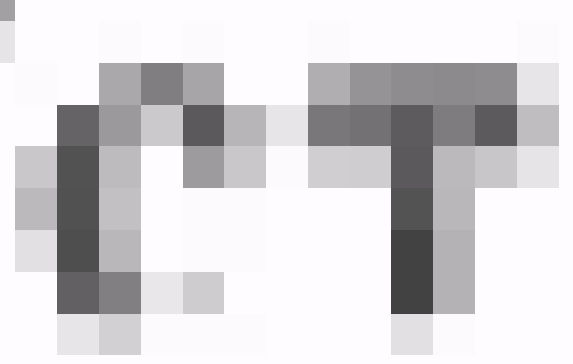
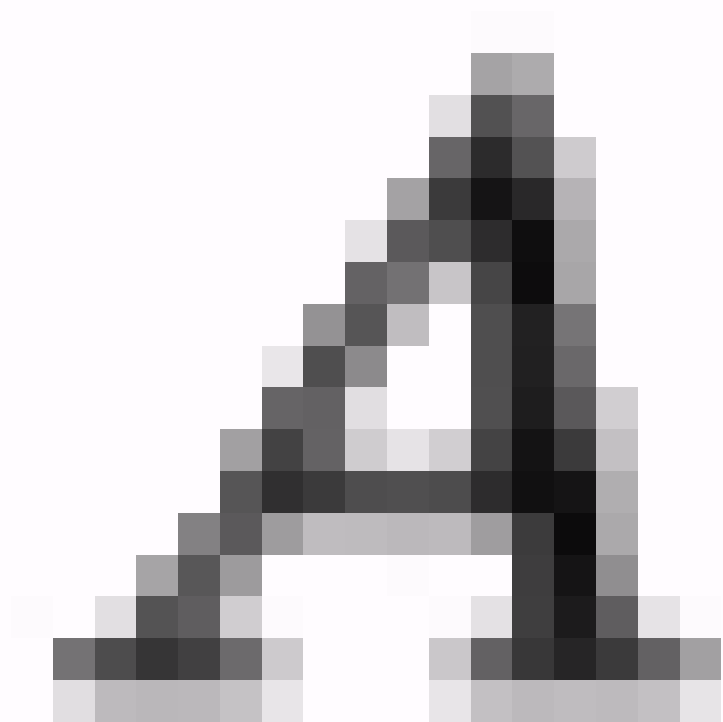

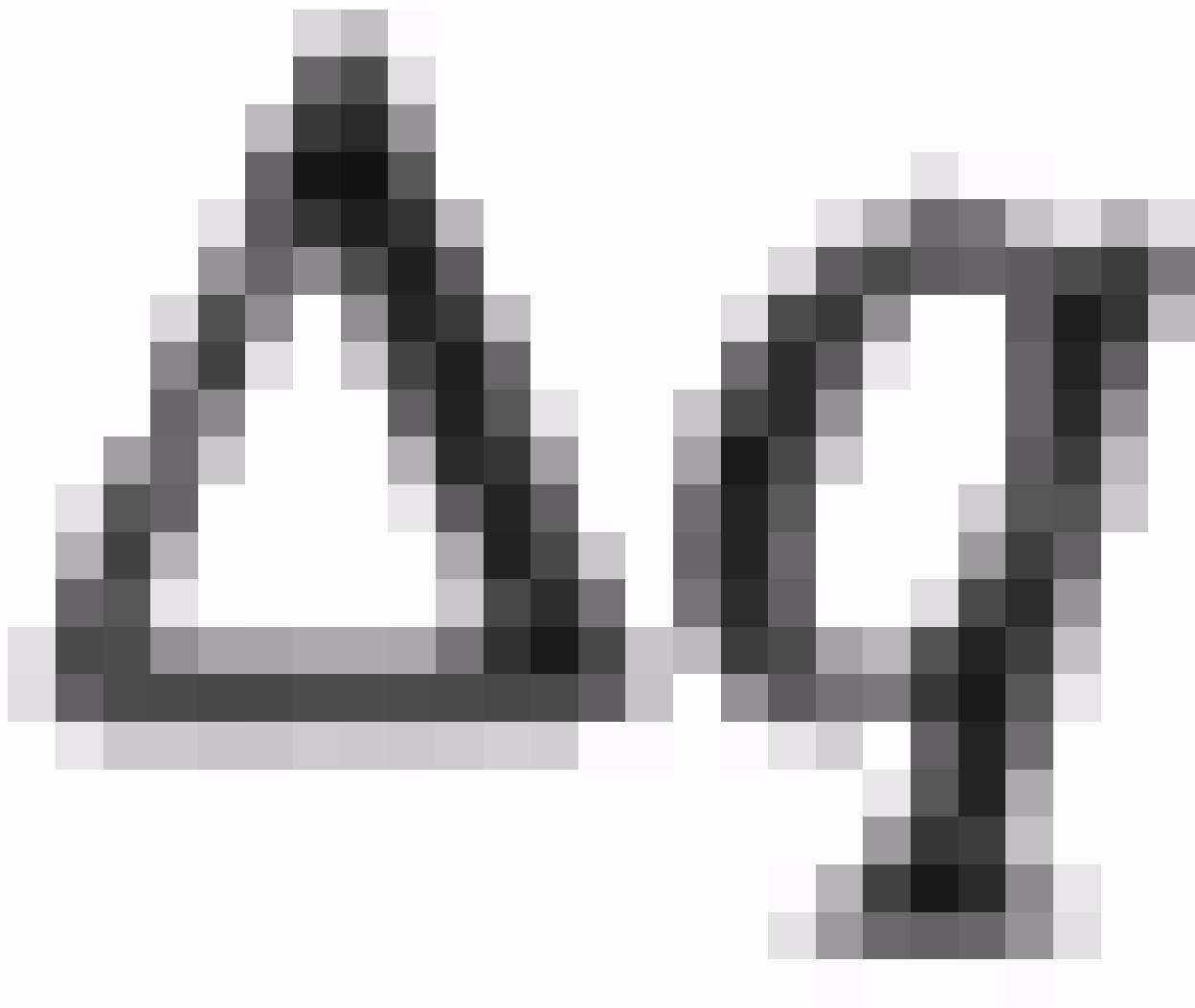

$$E = \frac{A_{\text{CT}}}{A_{\text{M}}}$$

(37.11)

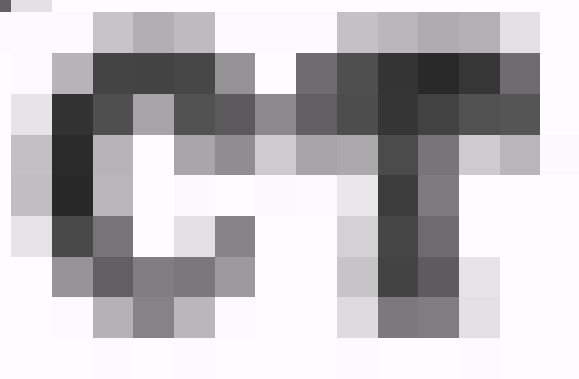
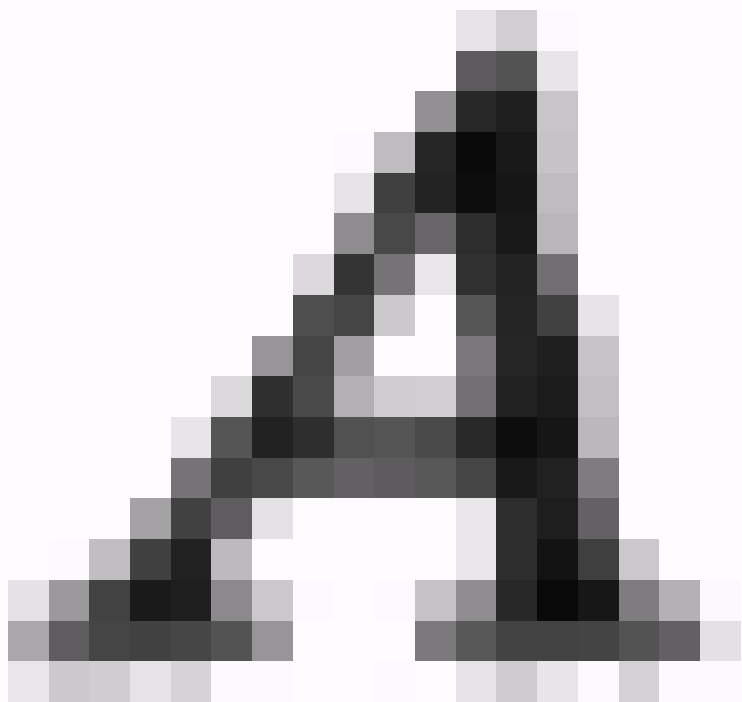

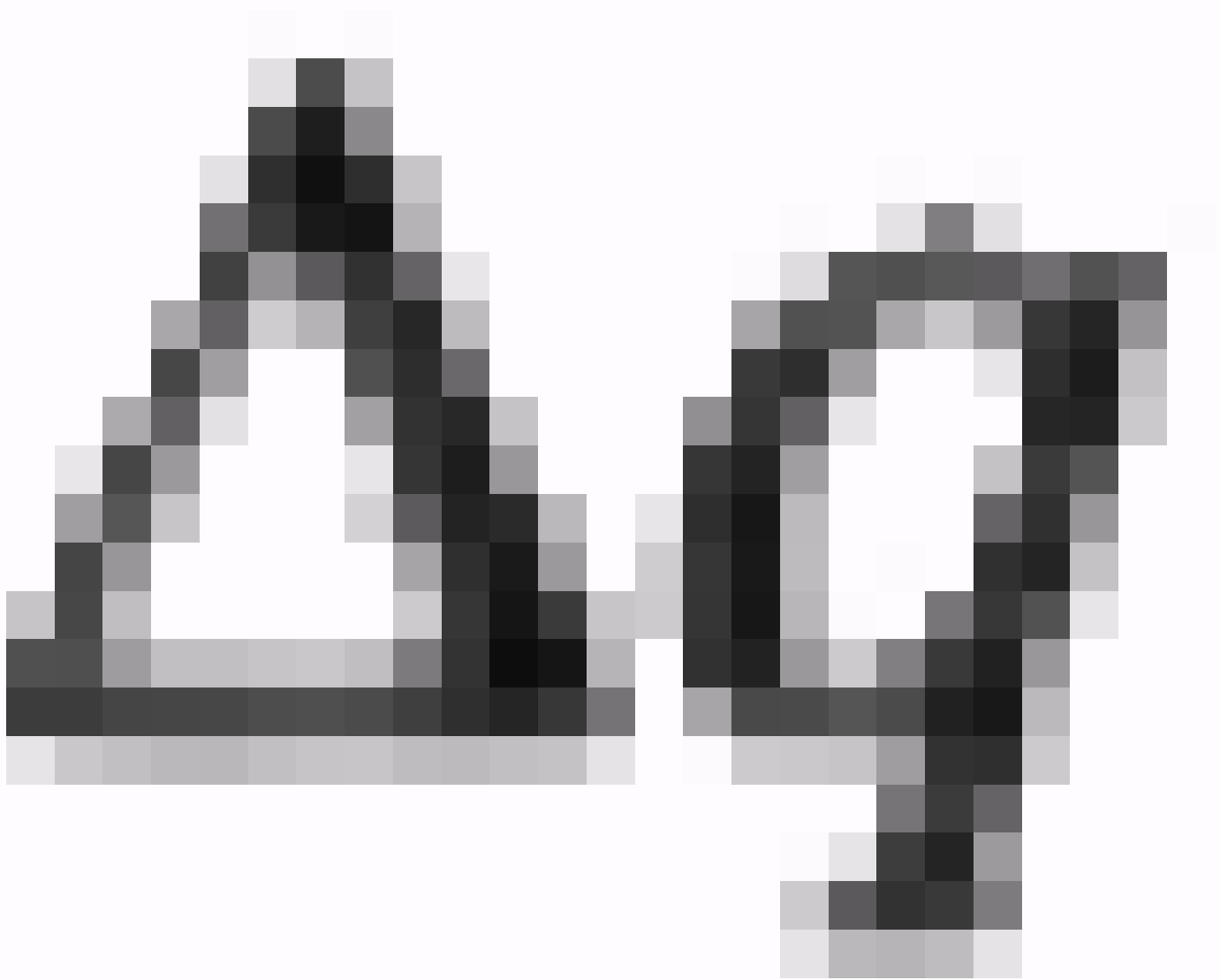

1997

April

ENGL

1997

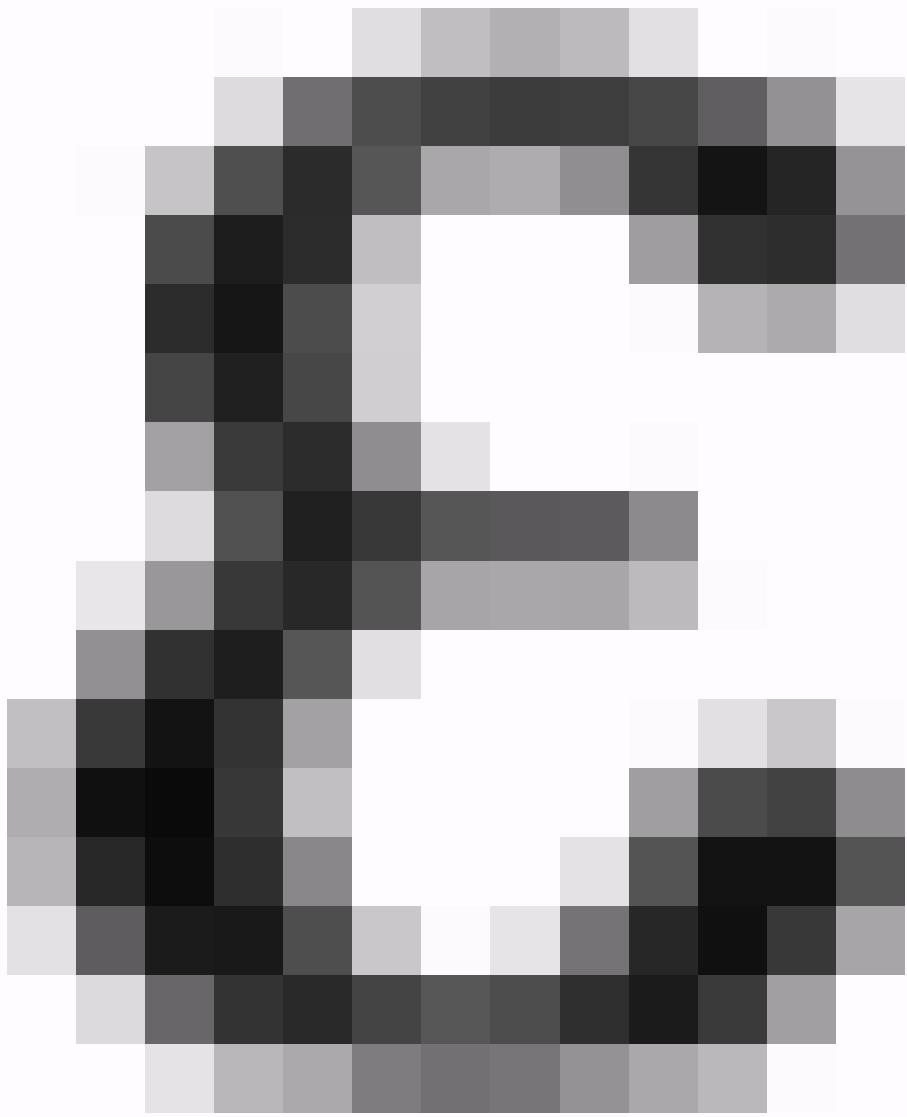

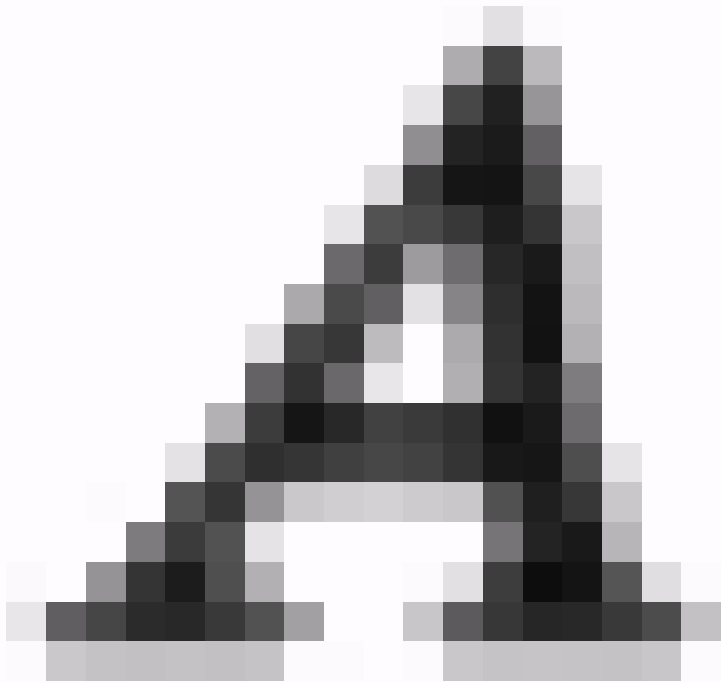

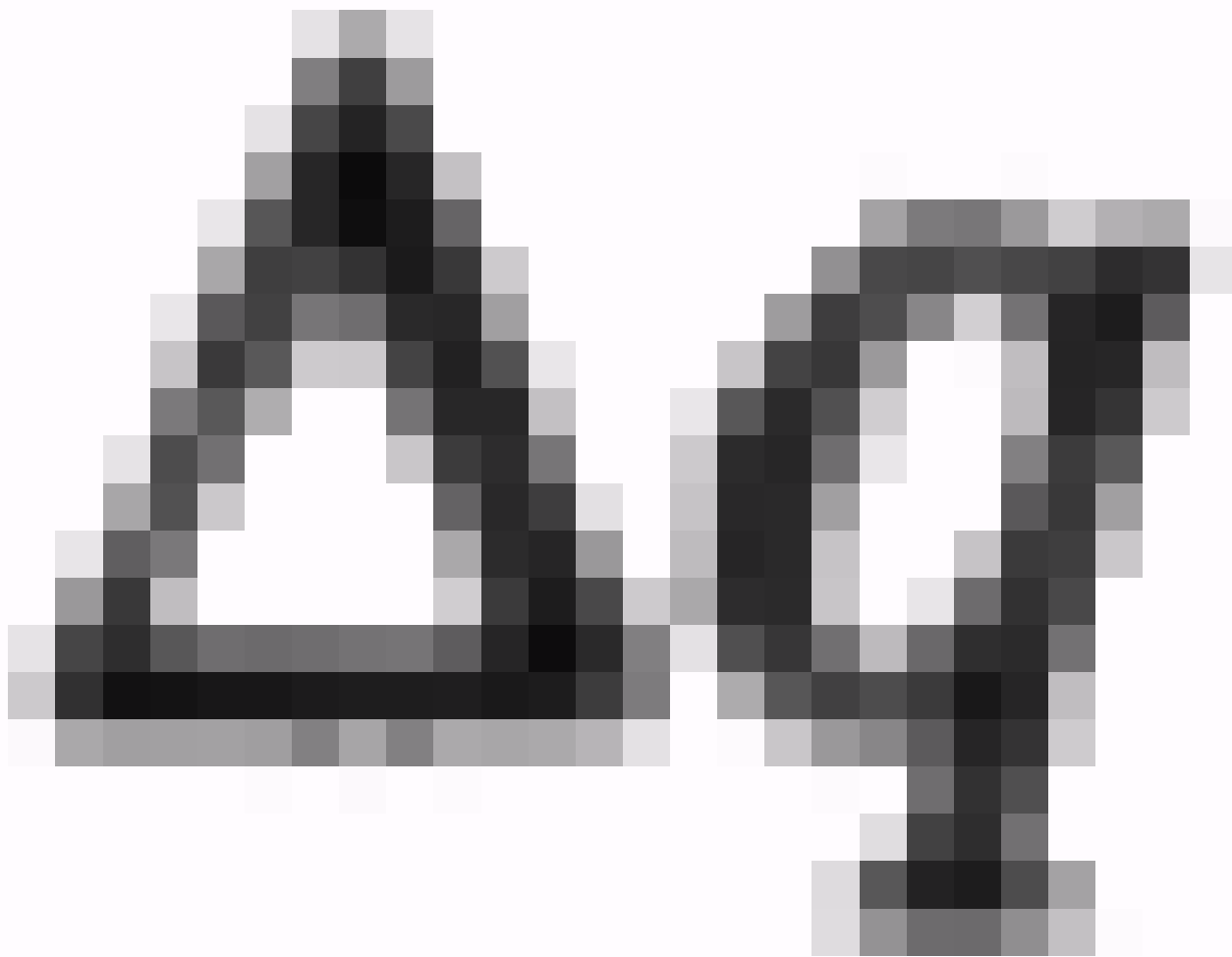

$$A_{CT} = A_{BH} + A_{JORN}$$

$$E \Delta Q = I^2 r \Delta t + I^2 R \Delta t \quad (27.13)$$

ERPR + PR (37.14)

$$i \cdot I = \frac{\varepsilon}{R + r} \quad (37.15)$$

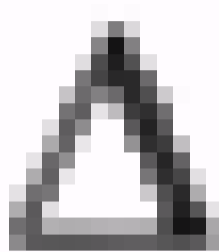
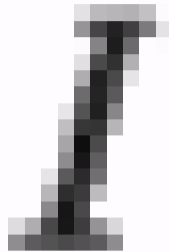
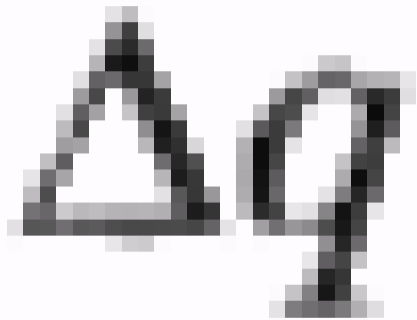

$$p = p_0(1 + \alpha \Delta T)$$

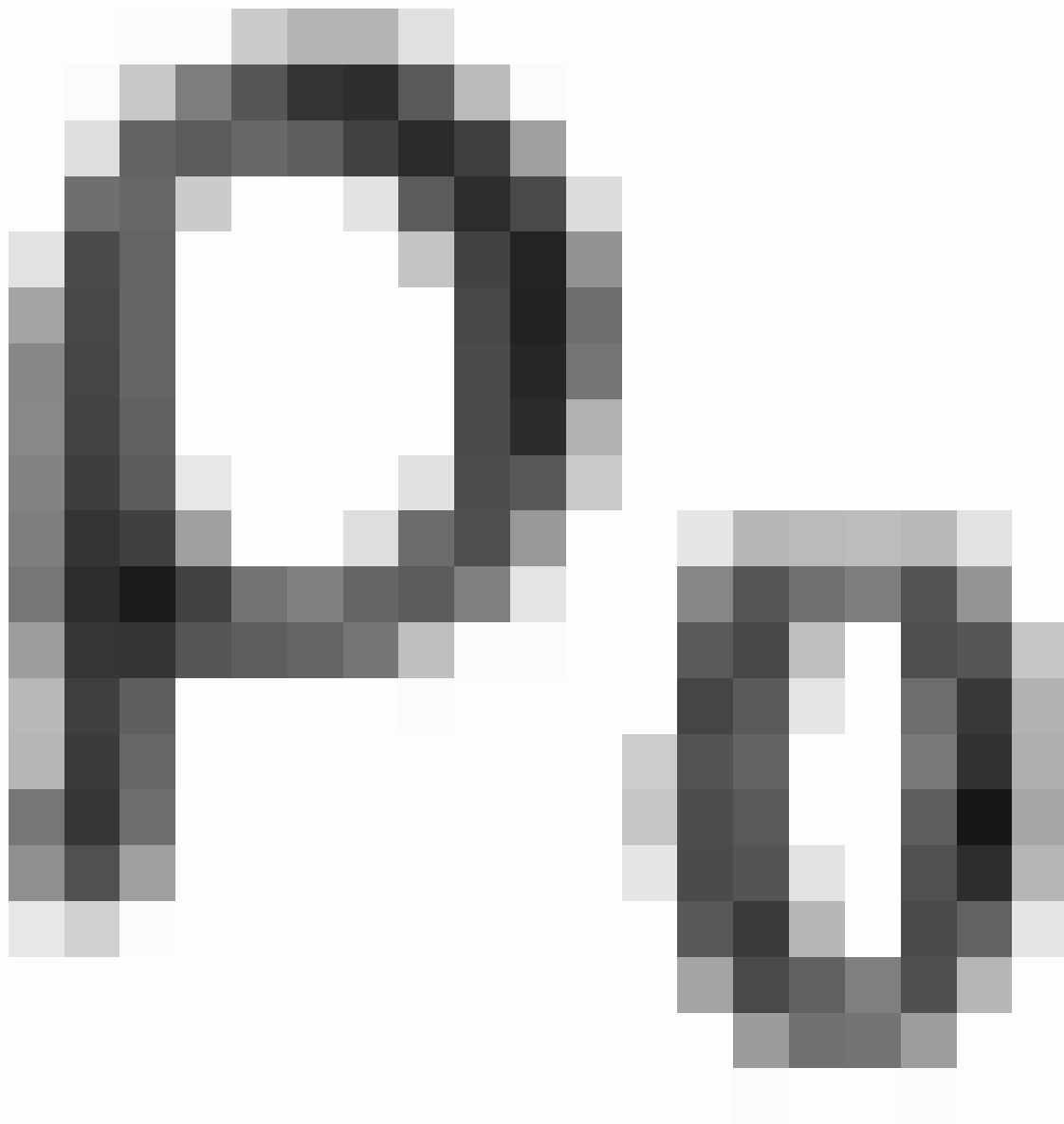

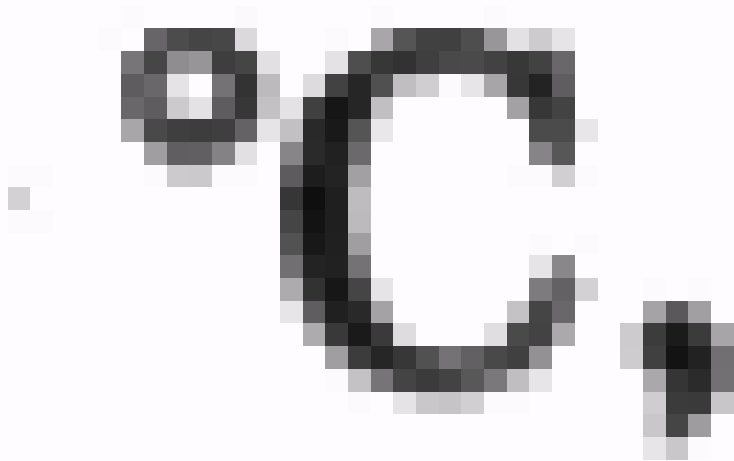
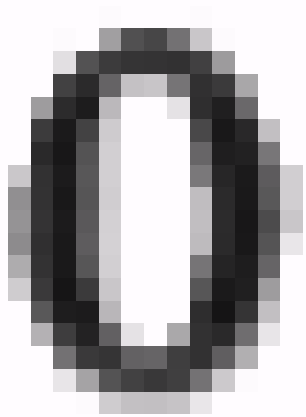

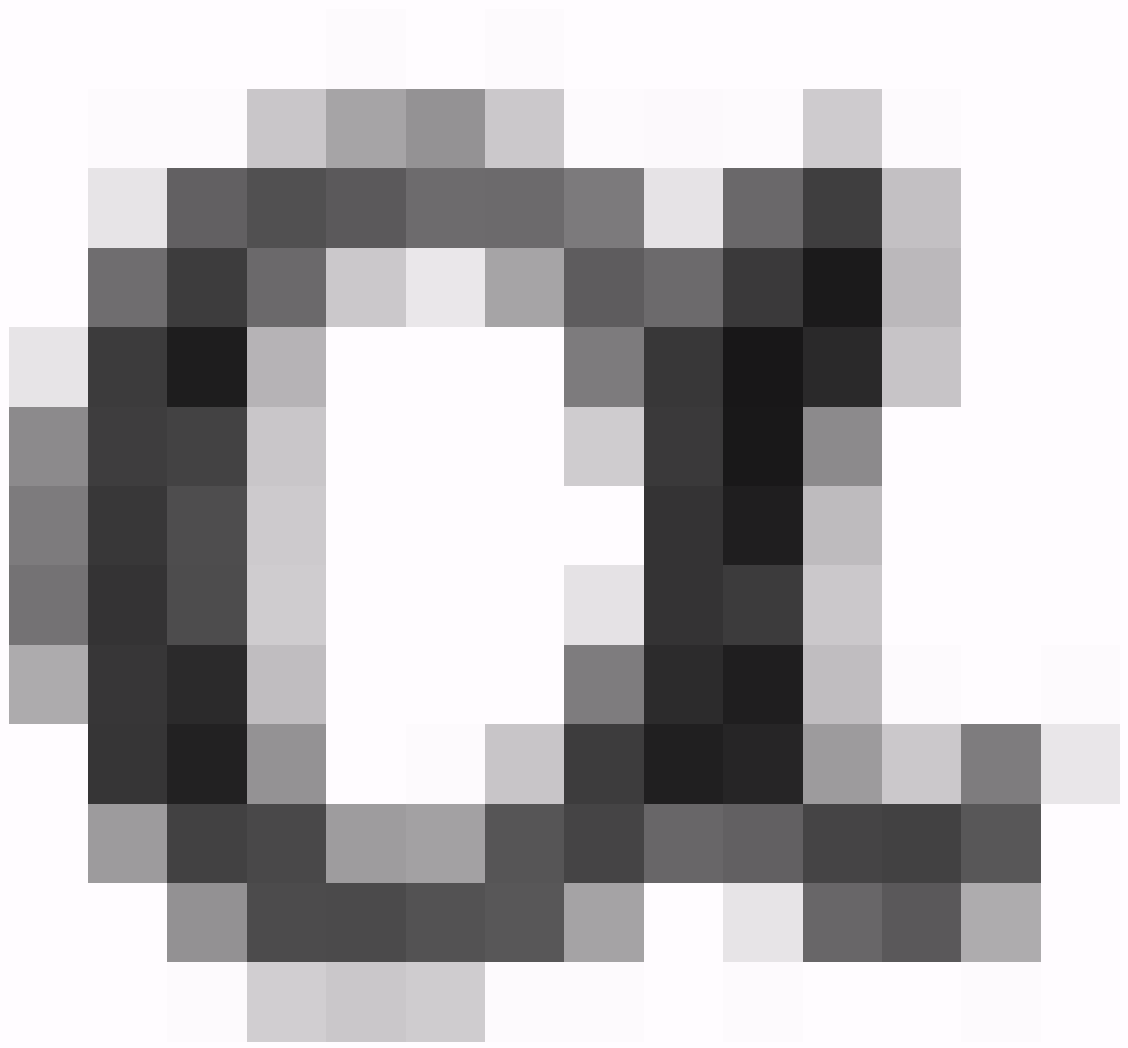

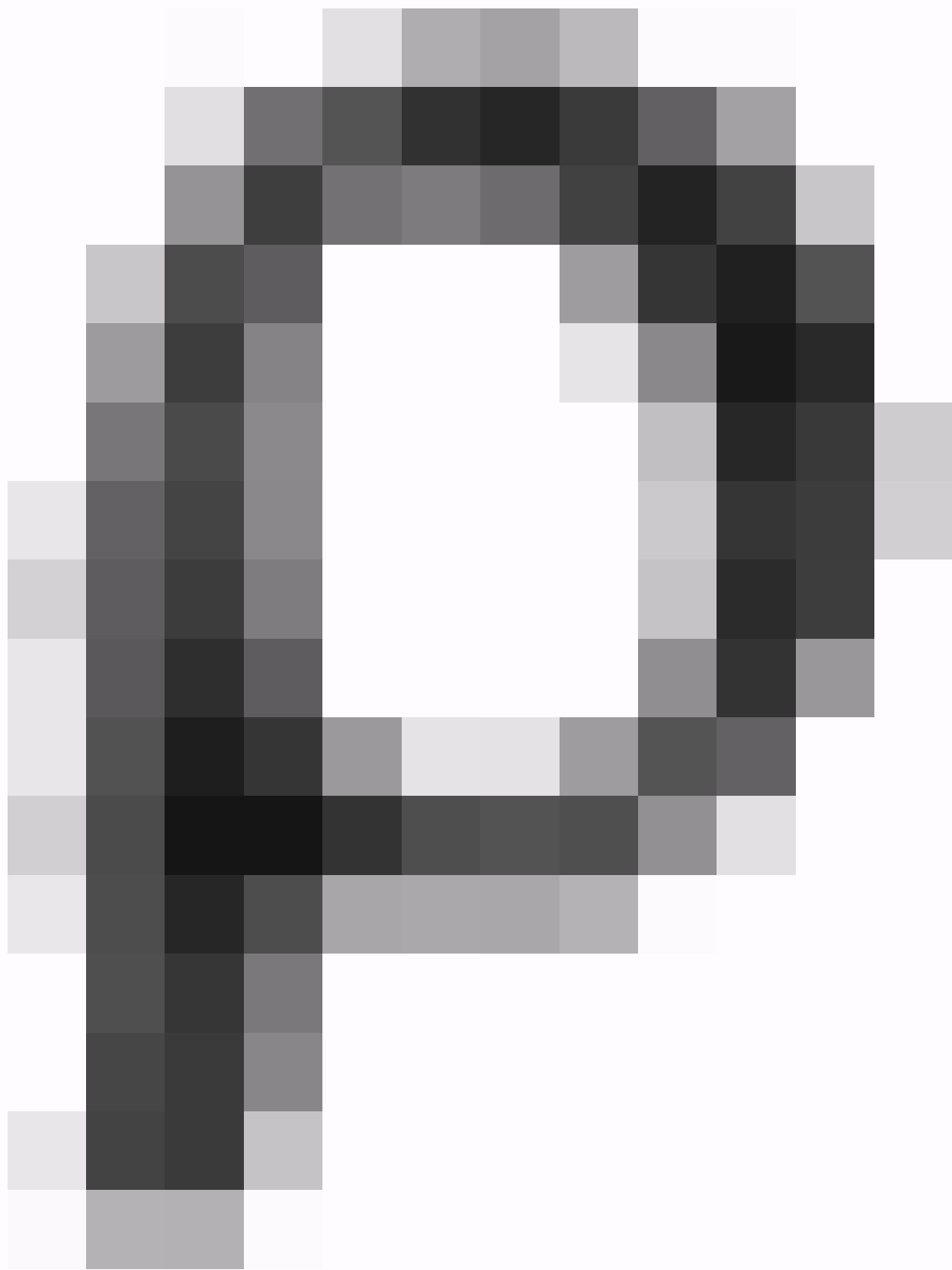

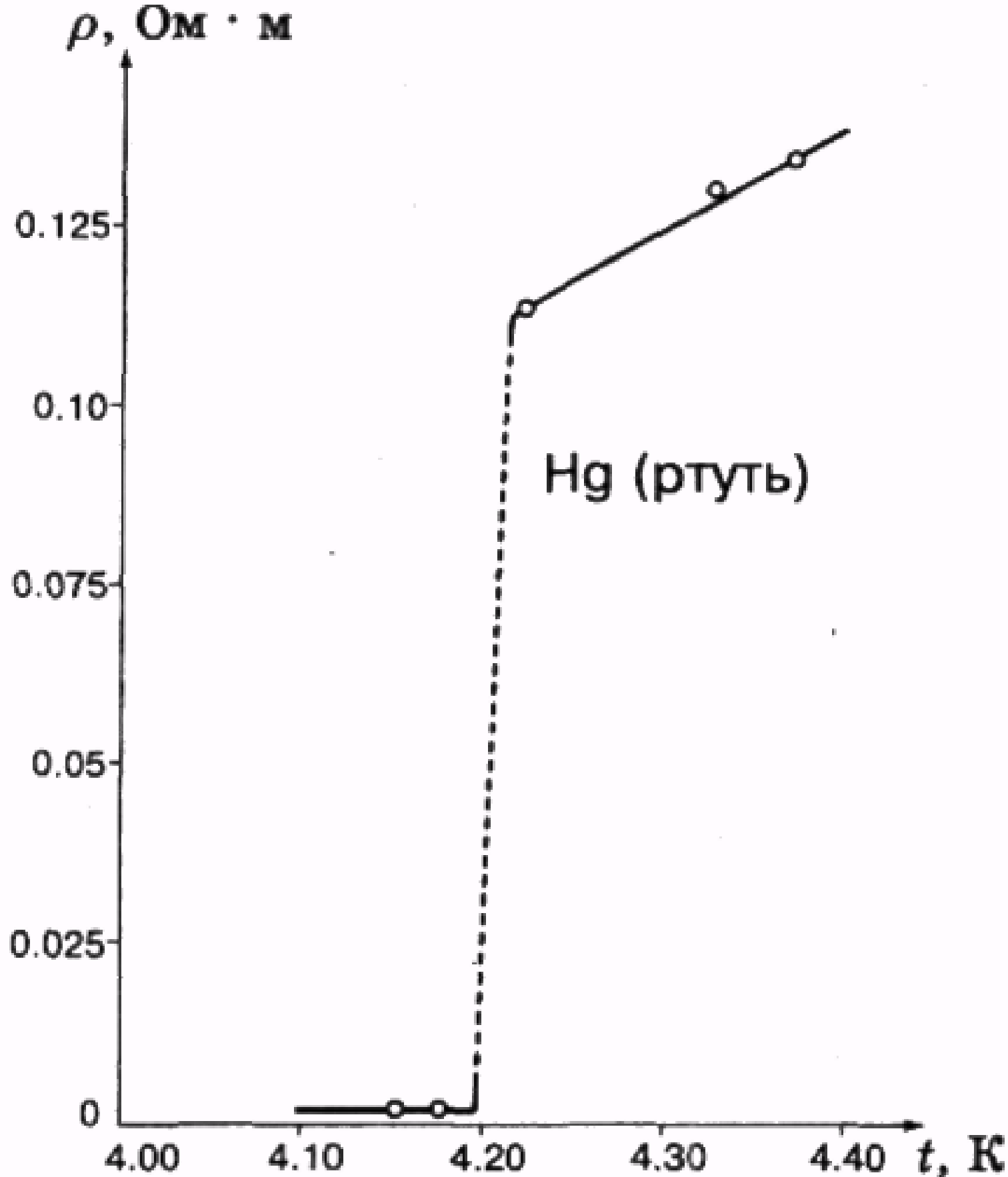

Мал. 2.121

1970-1971

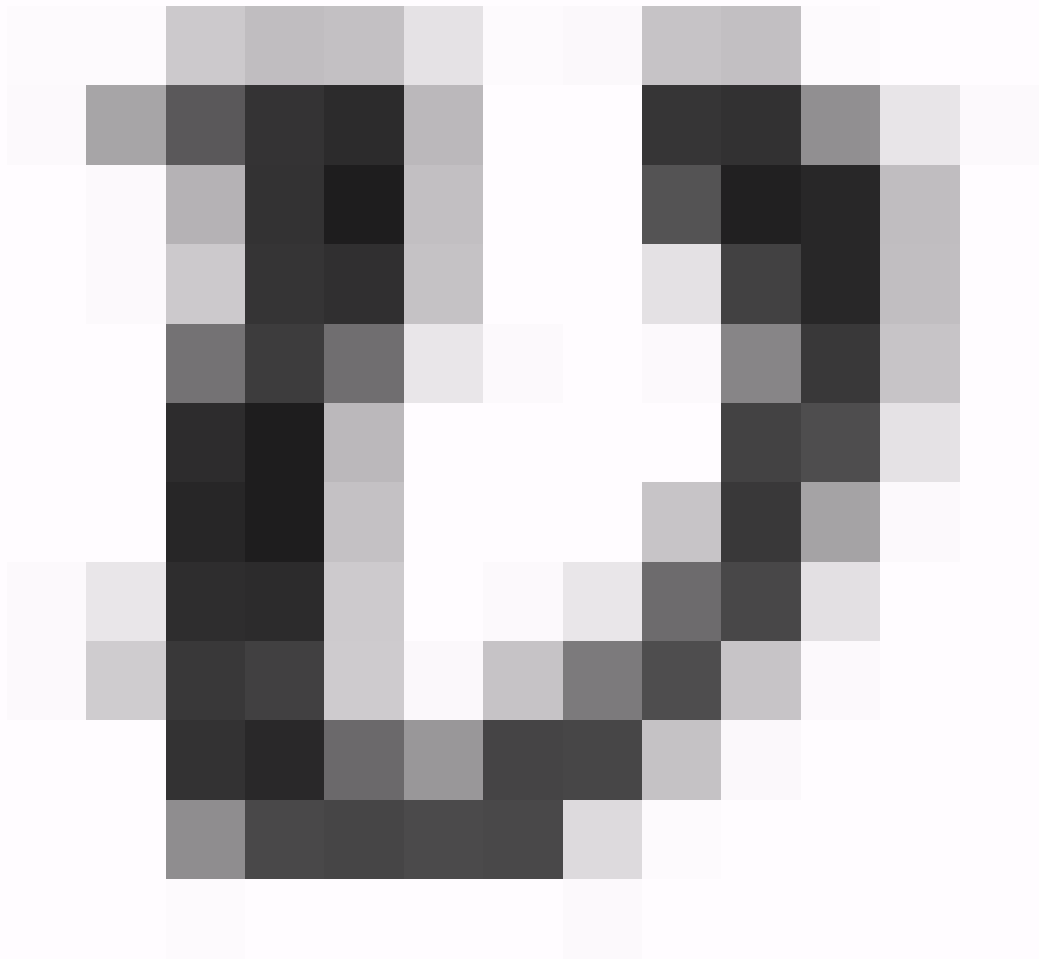

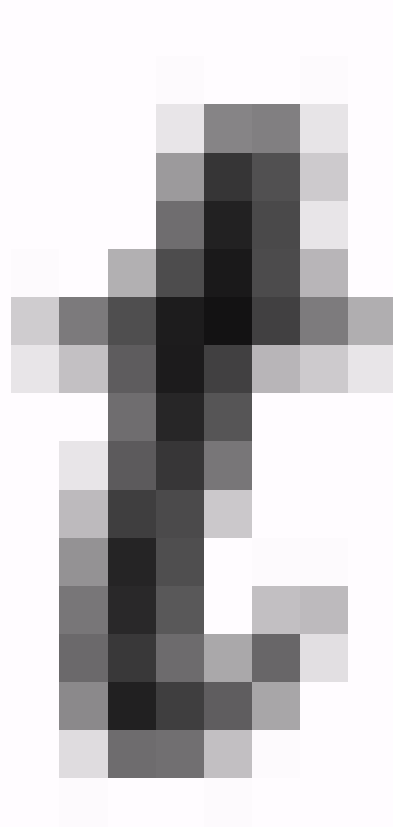
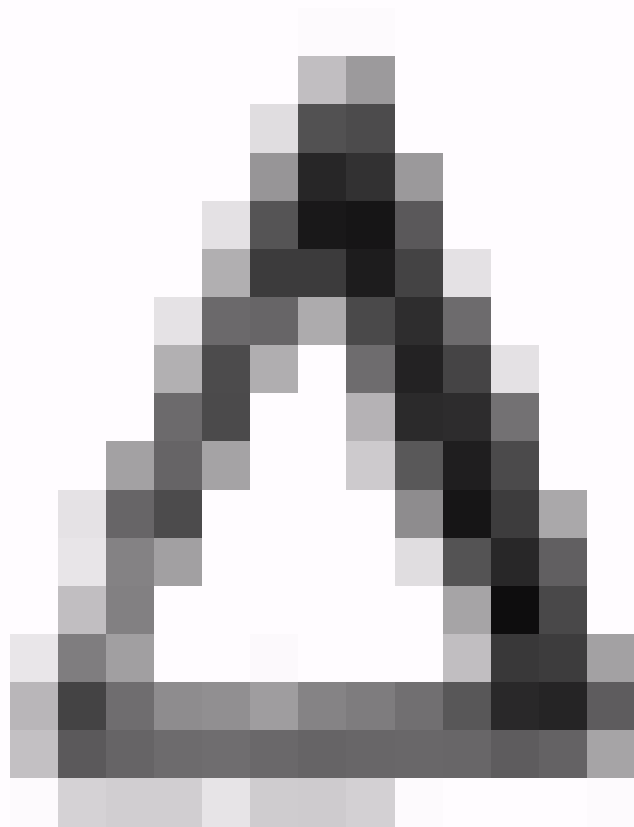

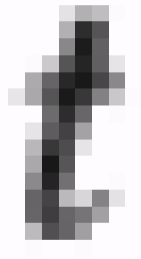
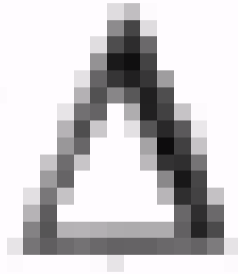
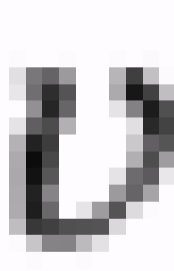
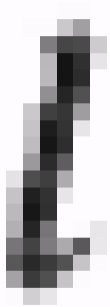

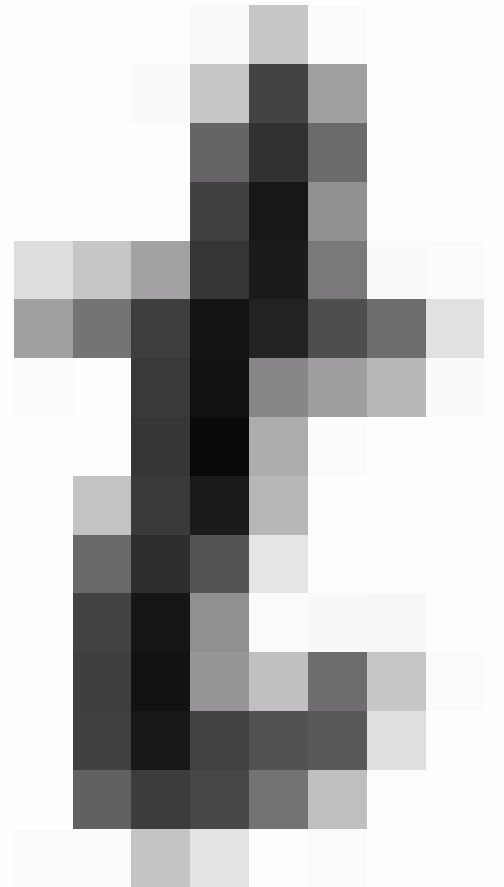
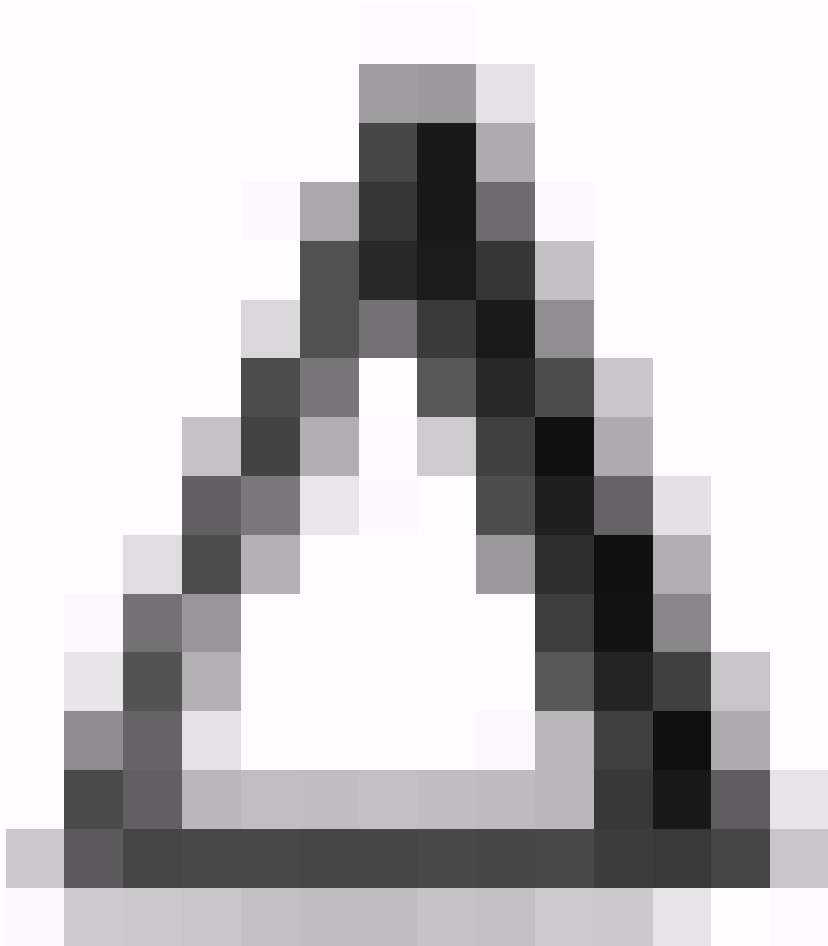

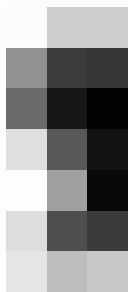
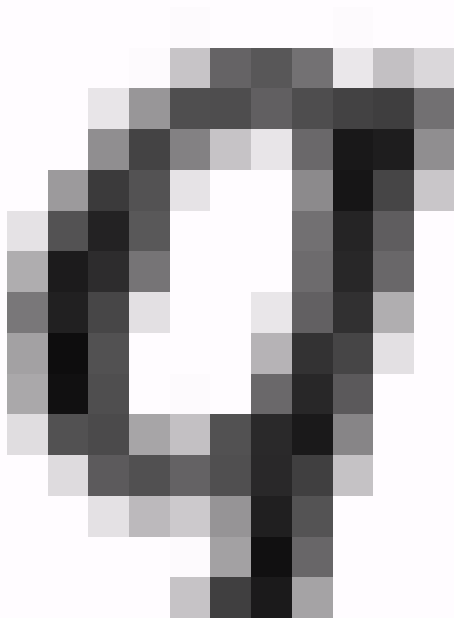
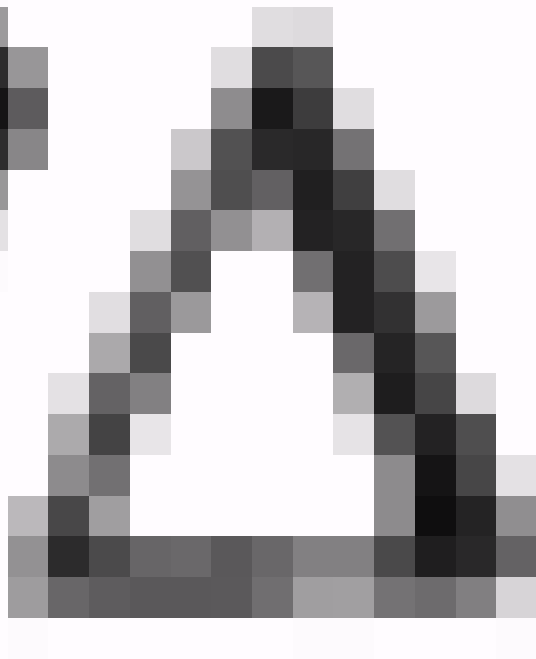
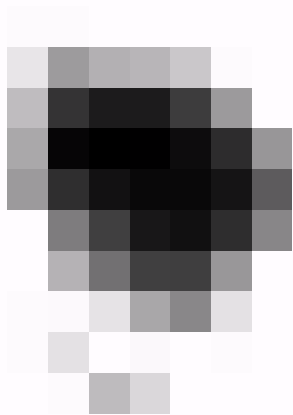

$\Delta Q = eV = e\mathcal{E}L$ (33.2)

$$I = \frac{\Delta Q}{\Delta t} = \text{emf} \quad (28.3)$$

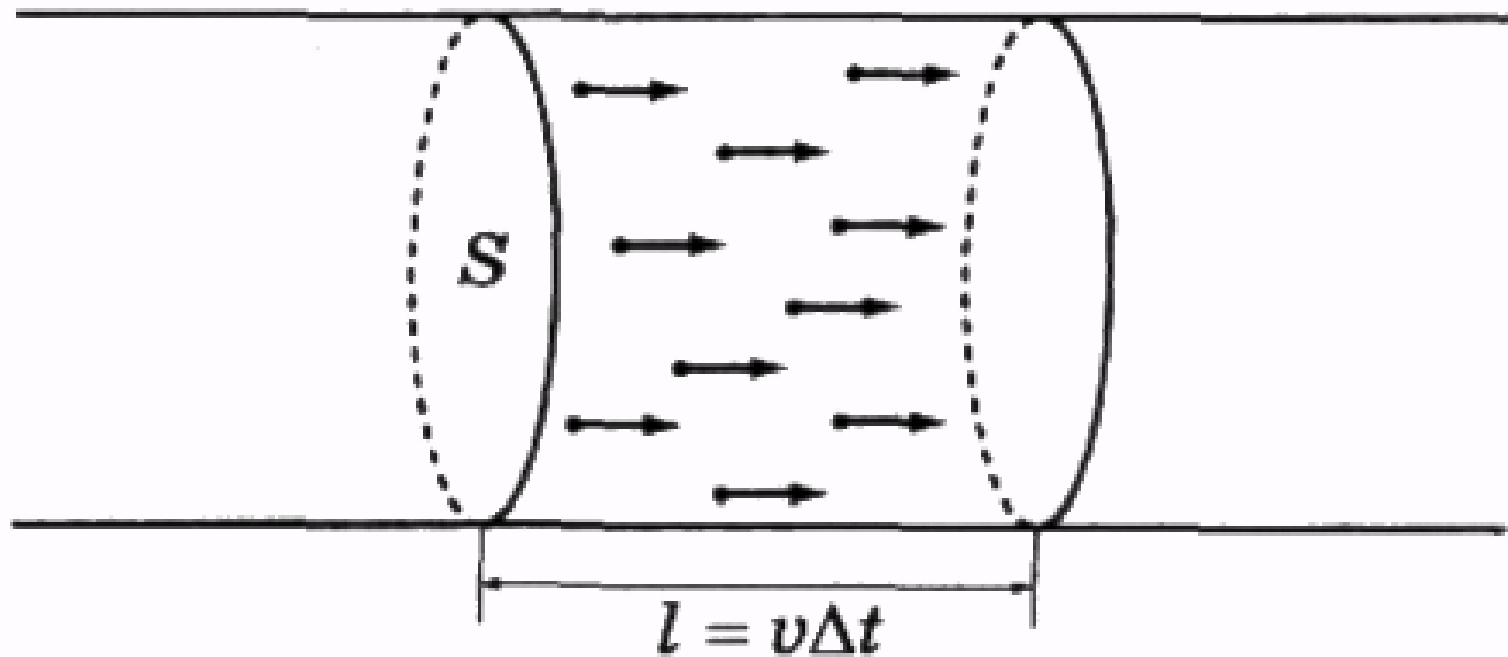

Мал. 2.122

$$v = \frac{I}{e n S}$$

(38.4)

1

2

3

4

5

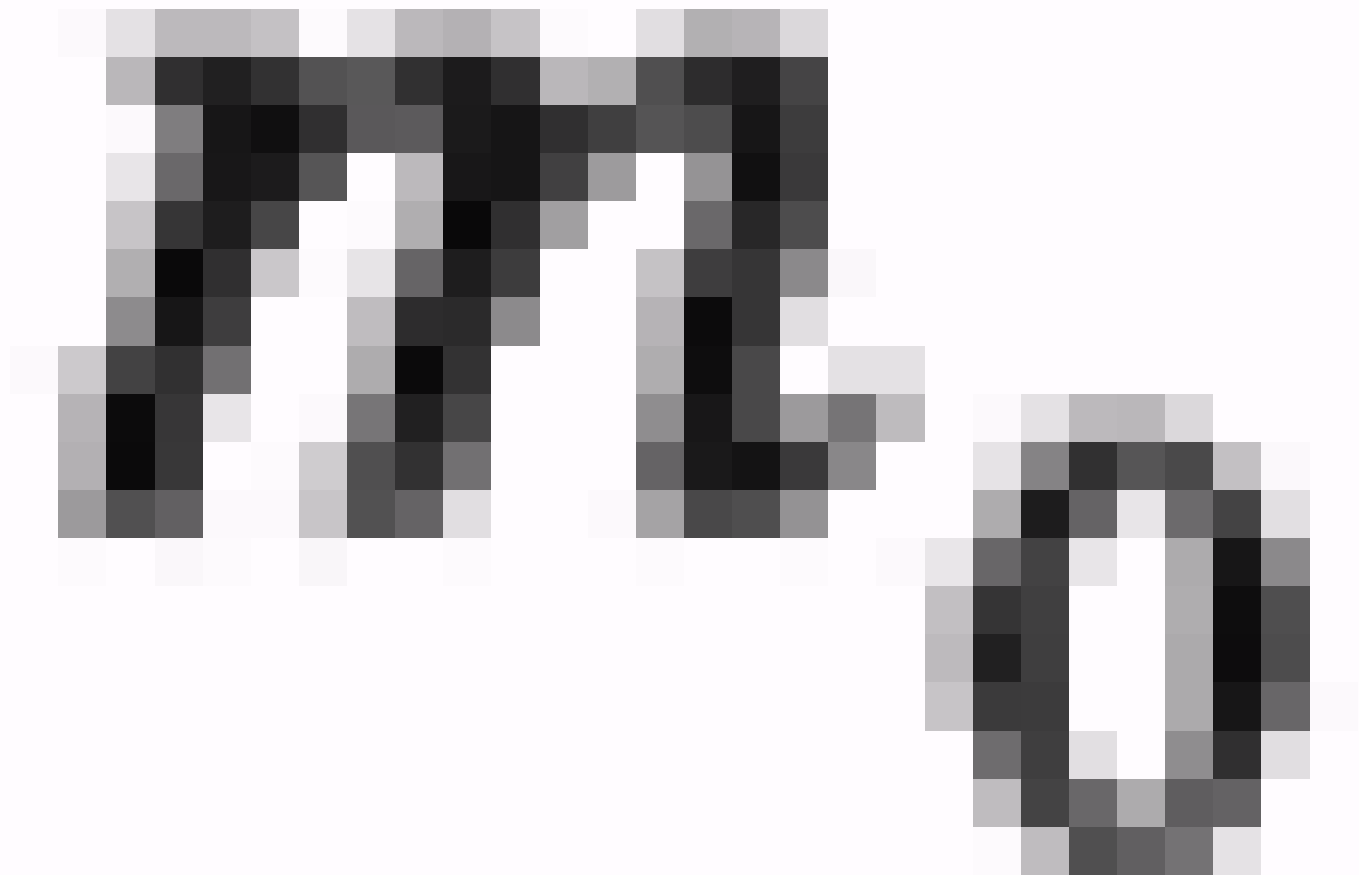

$$n = \frac{m}{V m_0} = \frac{\rho}{m_0} = \frac{2,7 \cdot 10^3 \text{ кг} / \text{м}^3}{4,5 \cdot 10^{-26} \text{ кг}} \approx 6 \cdot 10^{28} \text{ м}^{-3}$$

$$n = 6 \cdot 10^{28} \text{ м}^{-3}$$

$$e = 1,6 \cdot 10^{-19} \text{ Кл},$$

$$I = 1 \text{ А}, S = 10^{-6} \text{ м}^2$$

і значення

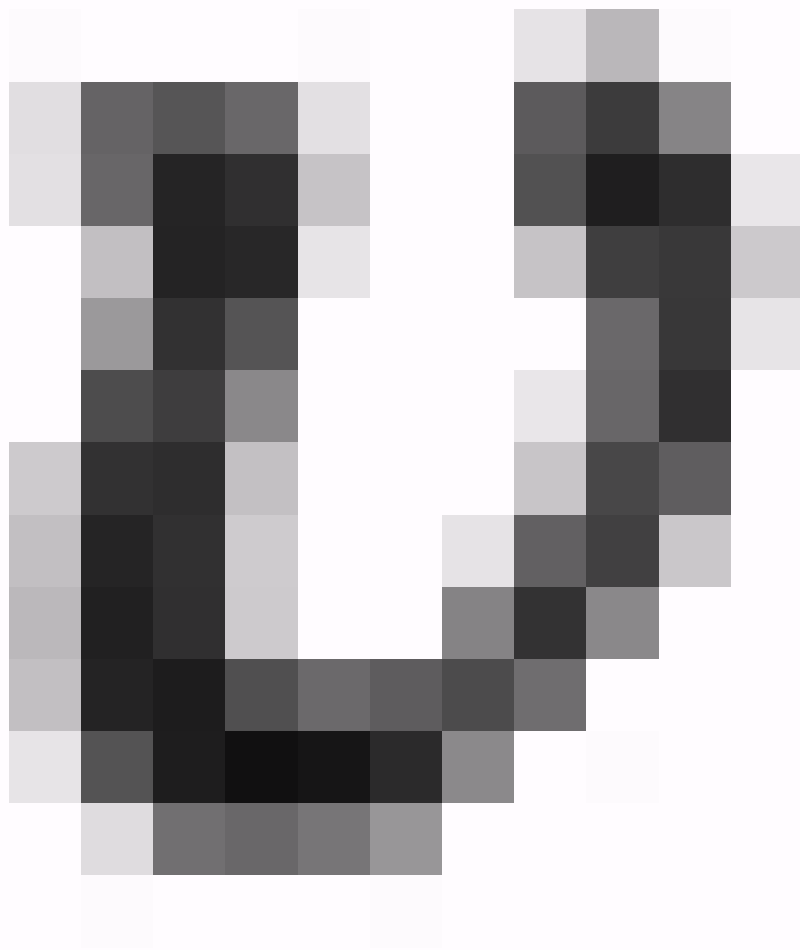

$$n = \frac{1A}{1,6 \cdot 10^{-19} \text{ Кл} \cdot 6 \cdot 10^{23} \text{ М}^{-3} \cdot 10^{-6} \text{ М}^2} \approx 10^{-4} \text{ м/с}$$

1011-1012

11 aB
11
101010
110101
110101
110101
110101

7

EB

2

1

1

+

2

.

1

0

-

1

0

1

1

.

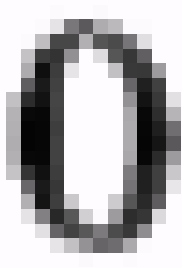
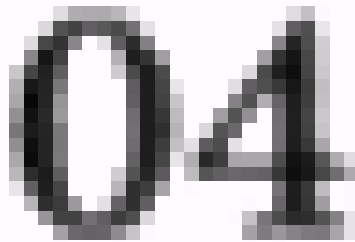
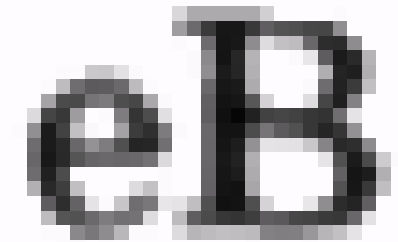
A pixelated, grayscale representation of the digit '0'. The digit is formed by a thick, dark gray outline with a white center. The edges are slightly blurred, giving it a soft, hand-drawn appearance.A pixelated, grayscale representation of the digit '1'. It is a simple vertical stroke with a small horizontal bar at the top, rendered in a dark gray color with a white background.A pixelated, grayscale representation of the digit '2'. The digit is formed by a thick, dark gray outline with a white center. The edges are slightly blurred, giving it a soft, hand-drawn appearance.A pixelated, grayscale representation of the digit '3'. The digit is formed by a thick, dark gray outline with a white center. The edges are slightly blurred, giving it a soft, hand-drawn appearance.A pixelated, grayscale representation of the digit '4'. The digit is formed by a thick, dark gray outline with a white center. The edges are slightly blurred, giving it a soft, hand-drawn appearance.

1004 1004 1004 1004 1004

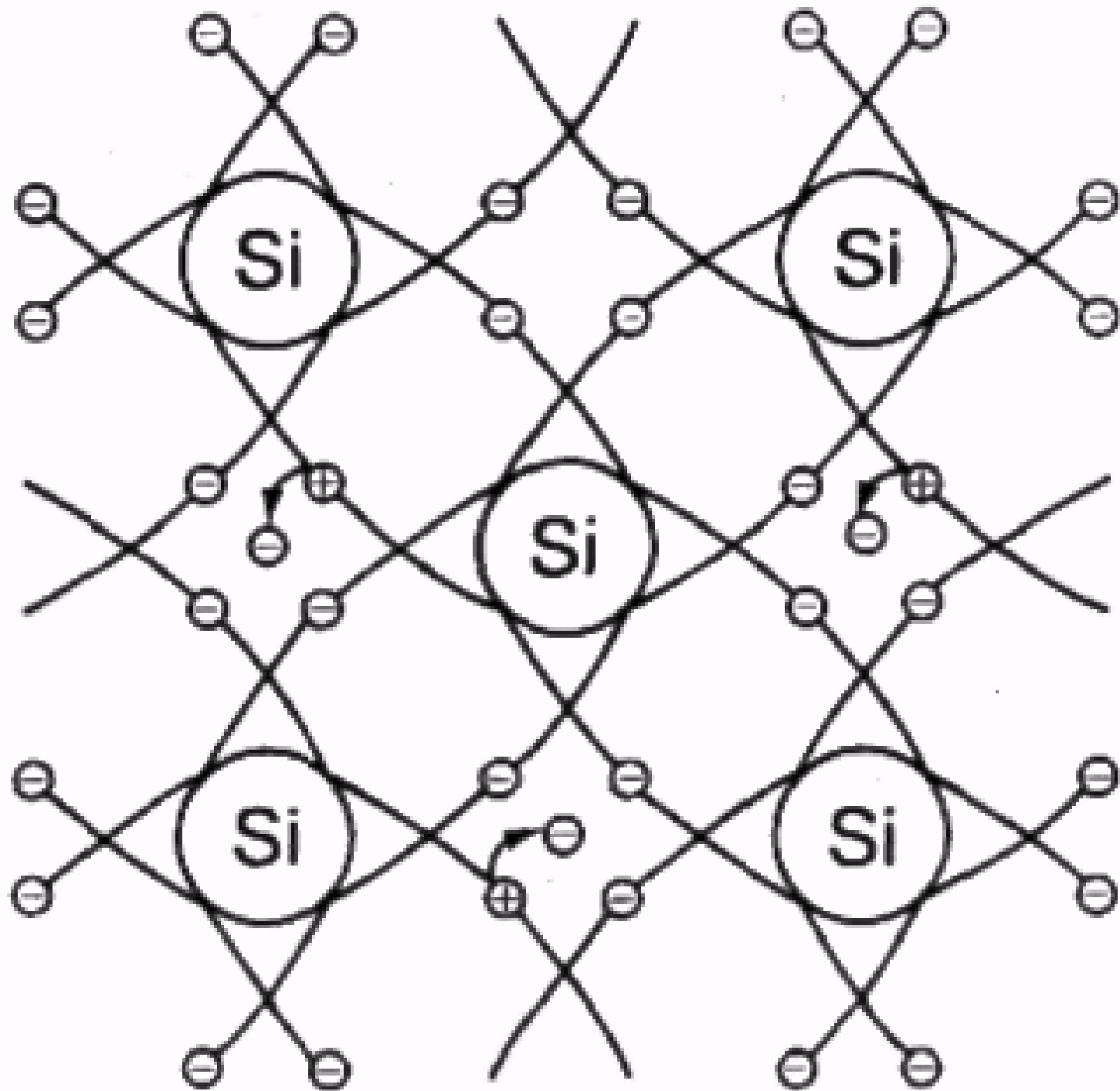

Мал. 2.123

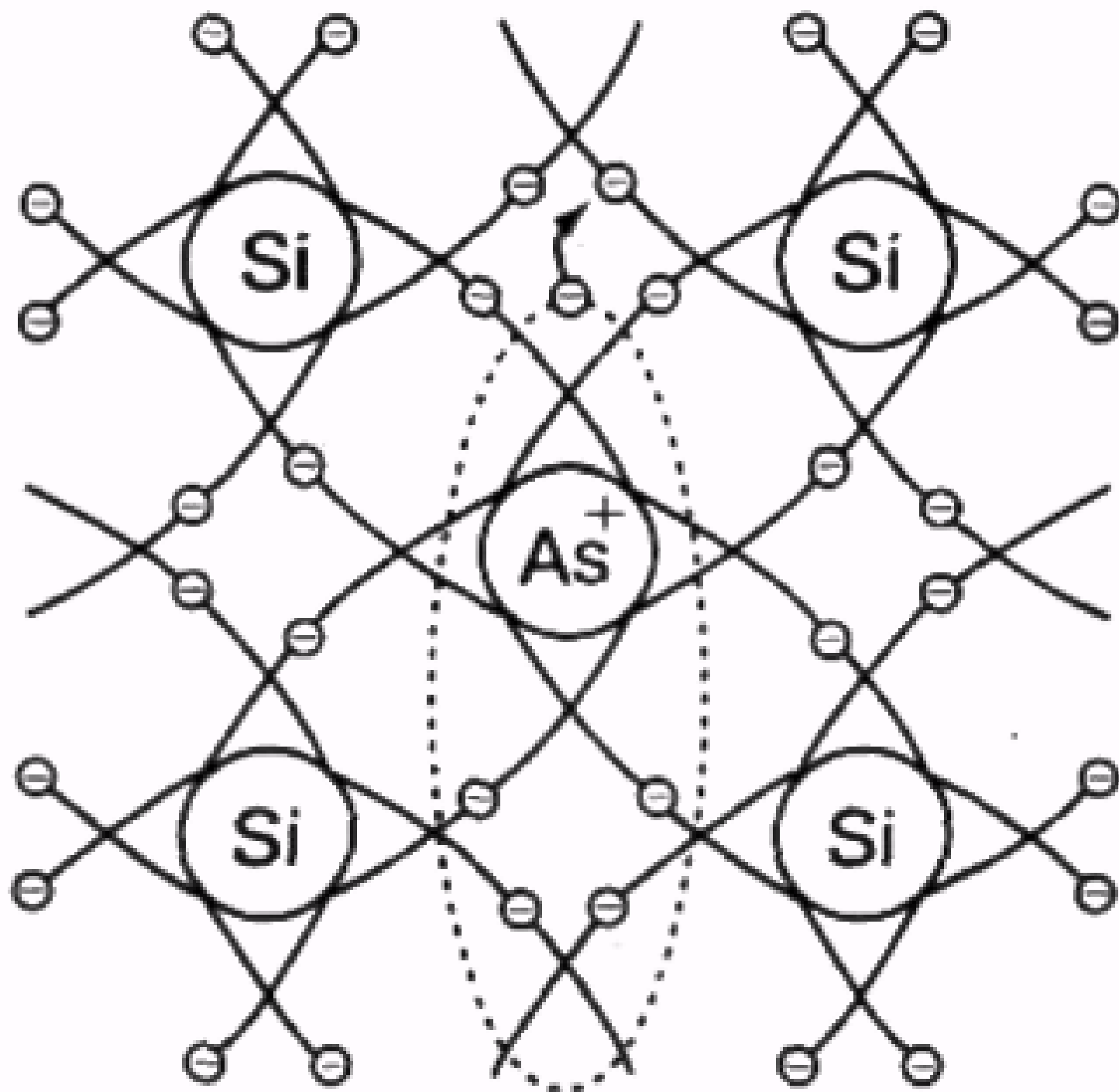

Мал. 2.124

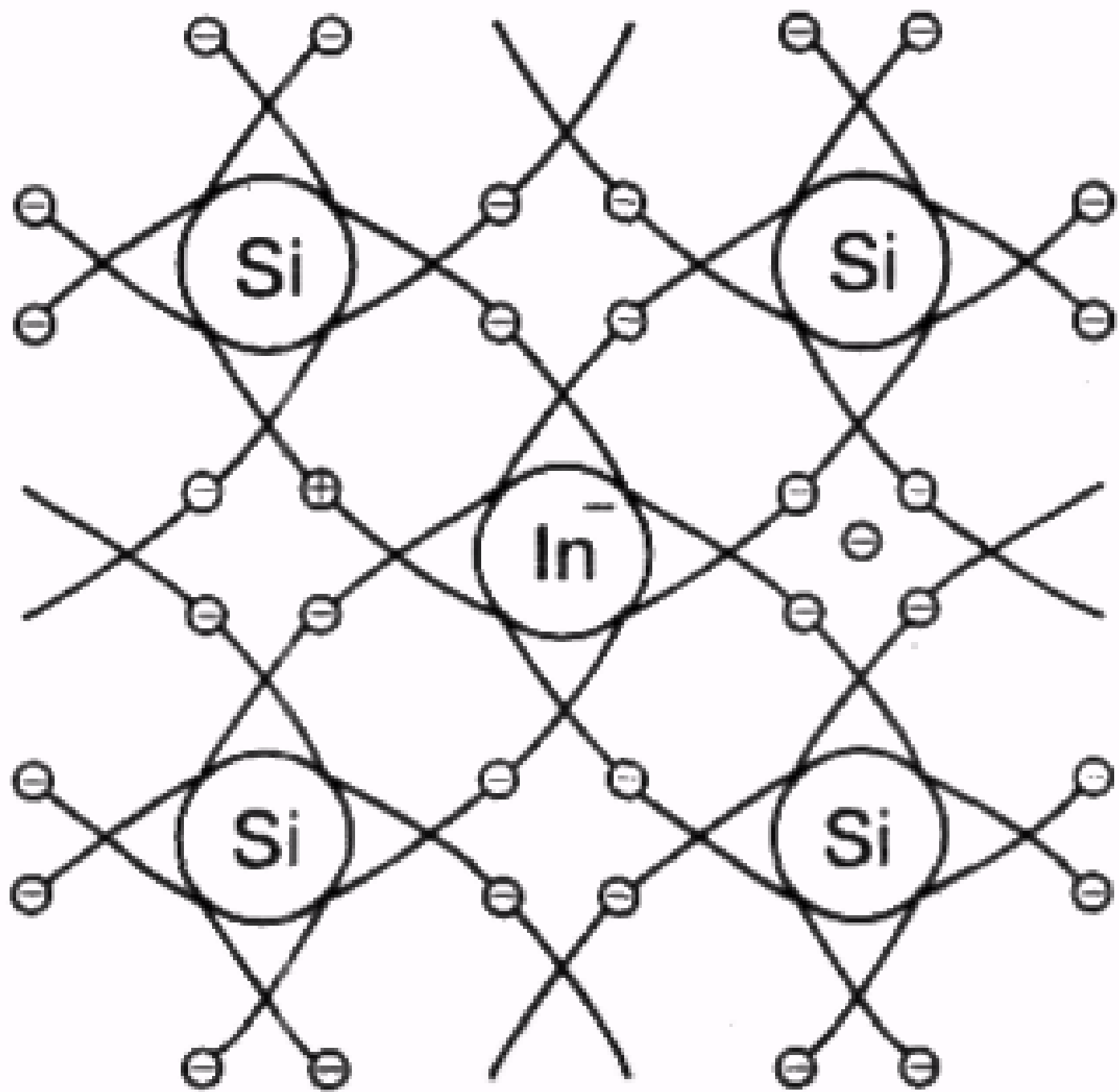

Мал. 2.125

p

n

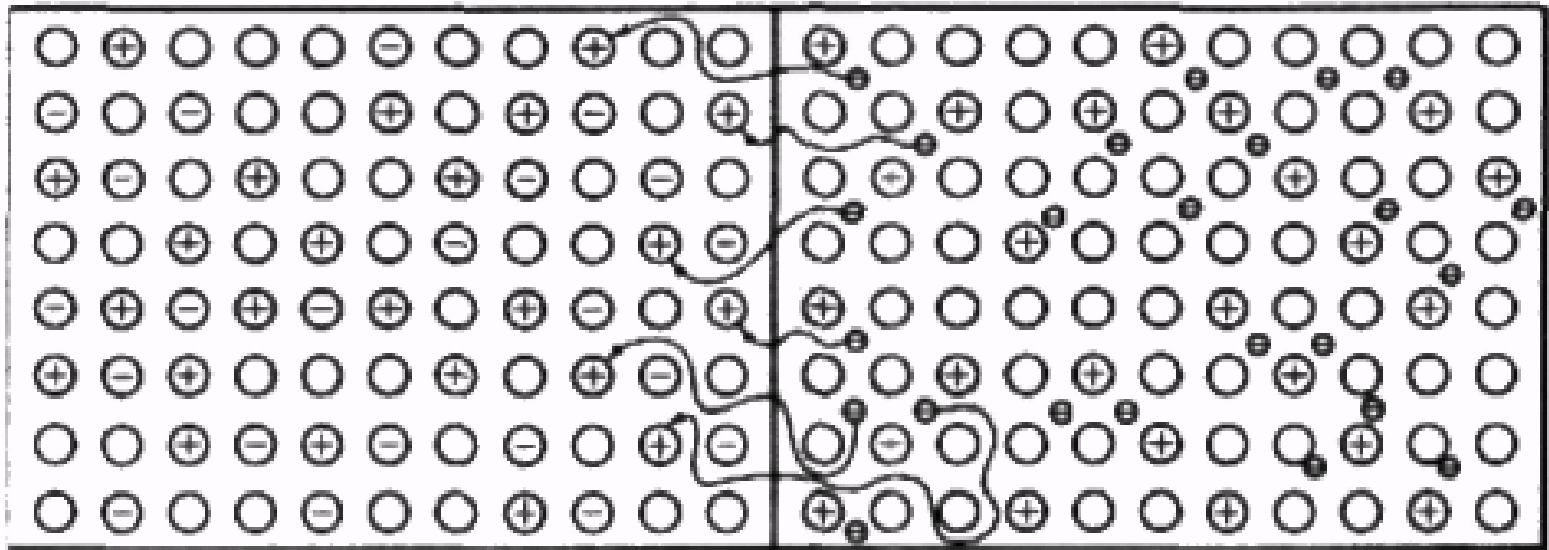

Мал. 2.126

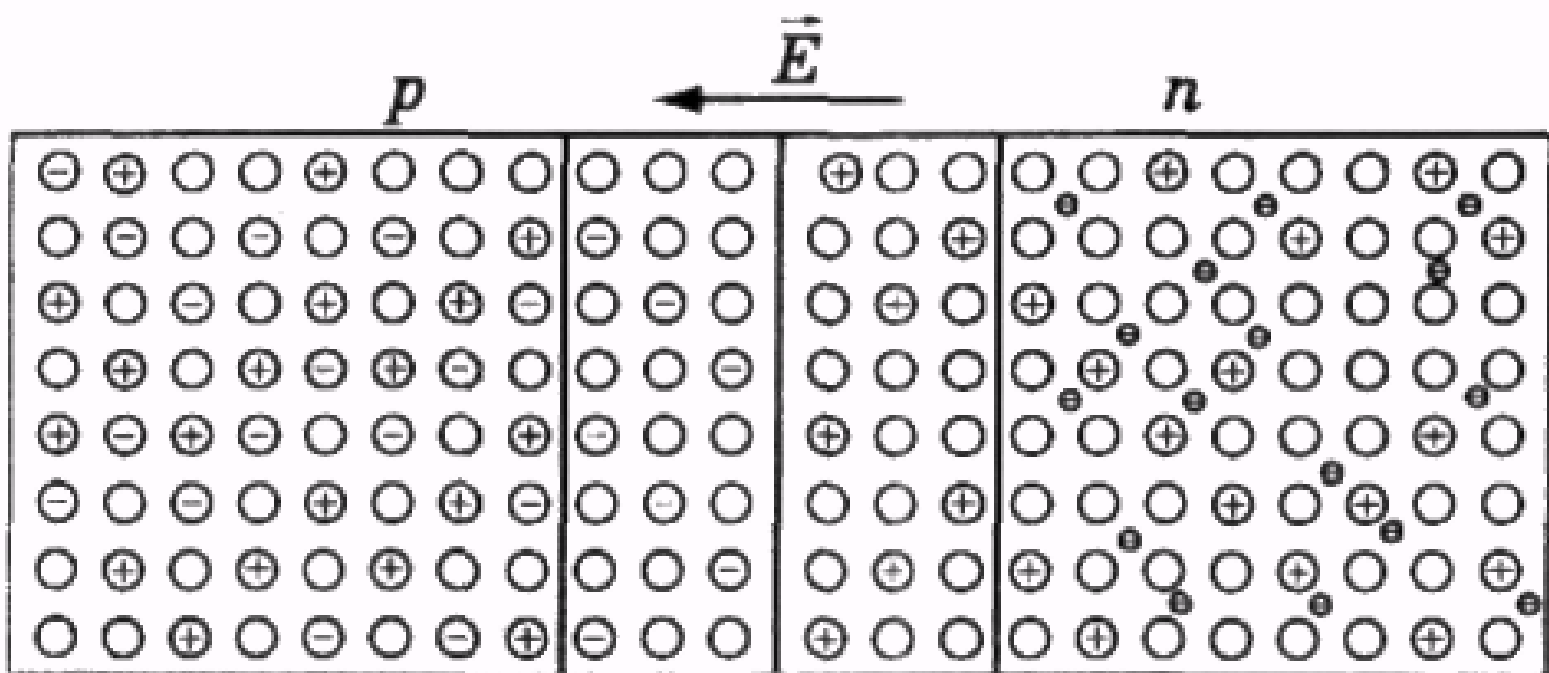

Мал. 2.127

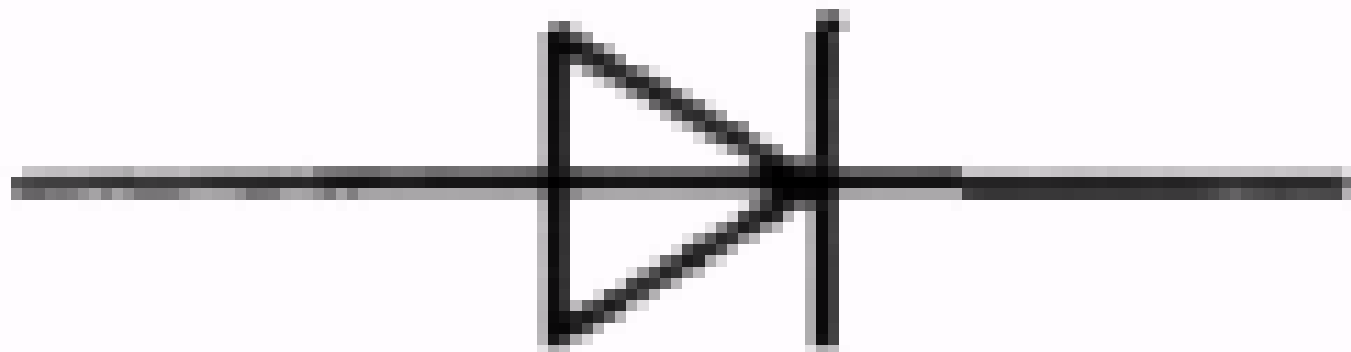

Мал. 2.128

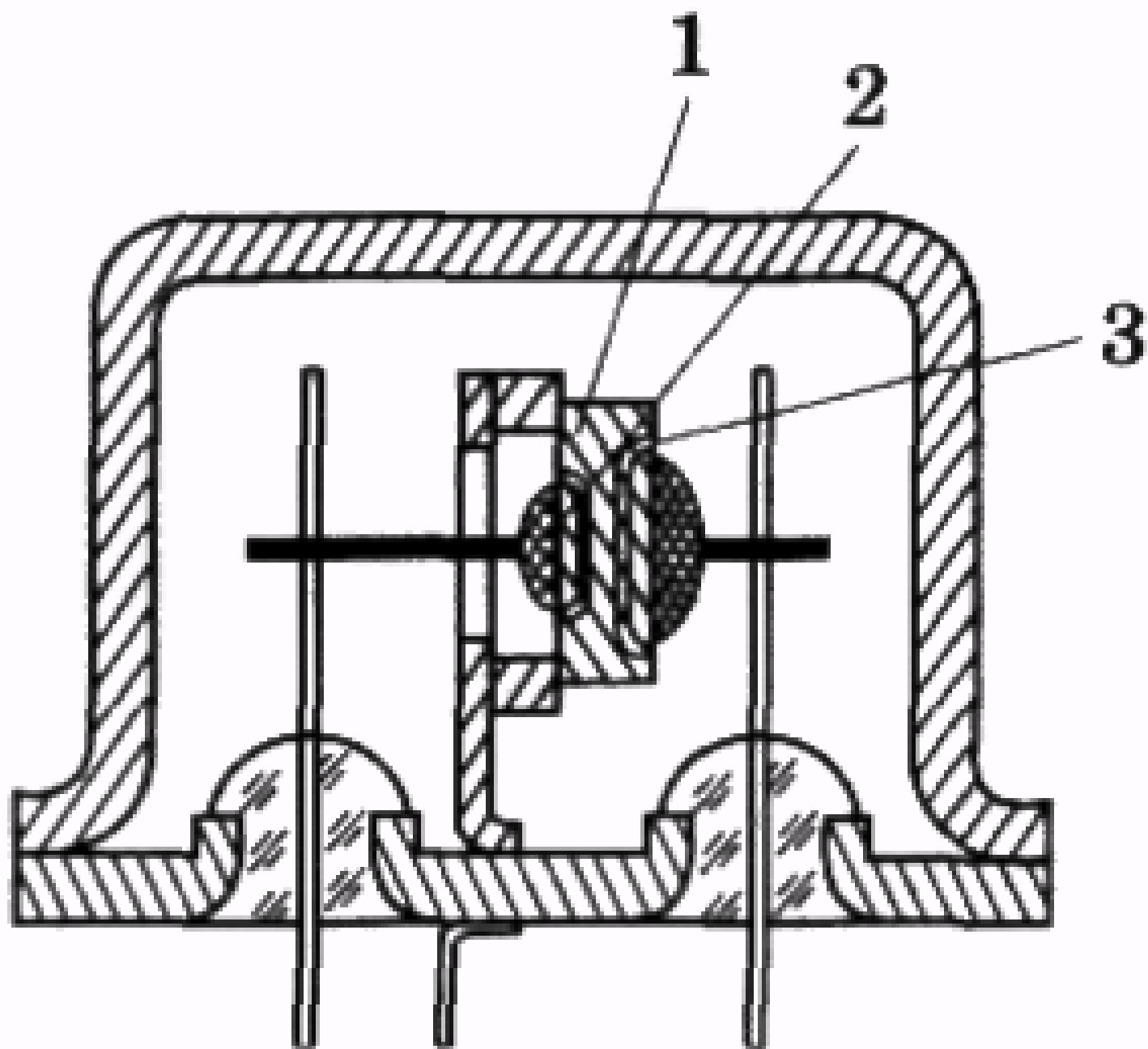

Мал. 2.129

p-n-p

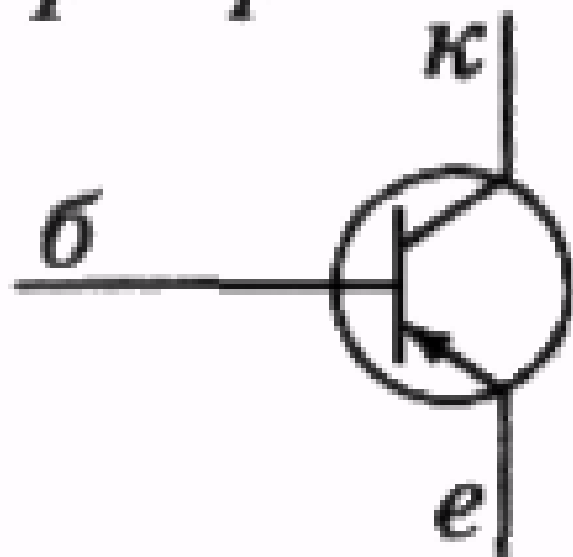

n-p-n

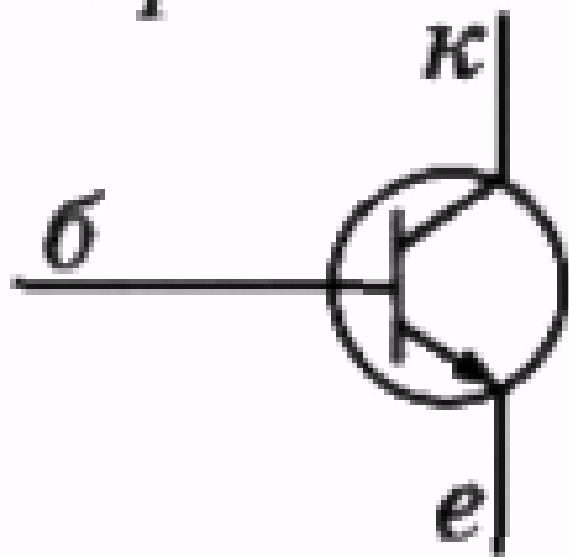

Мал. 2.130

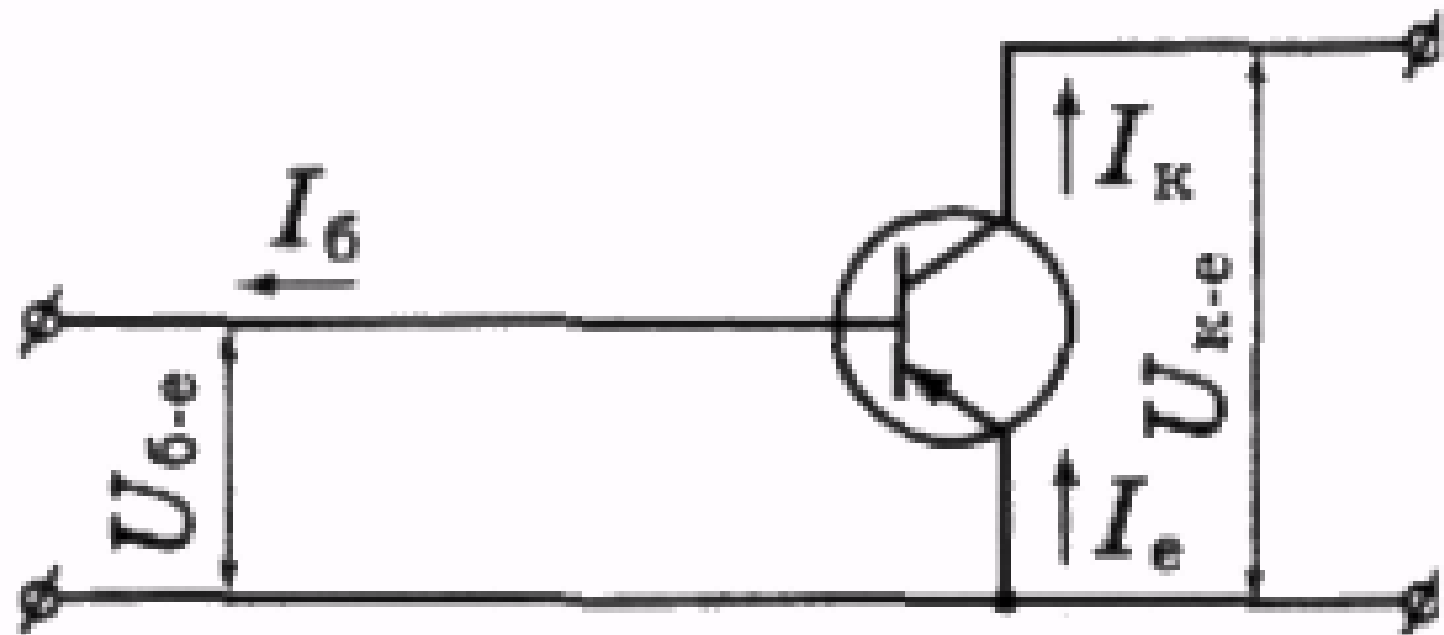

Мал. 2.131

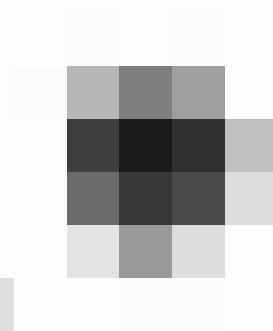
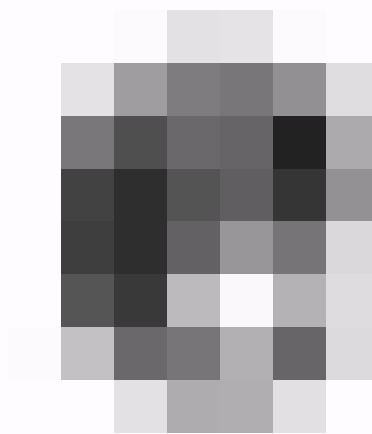
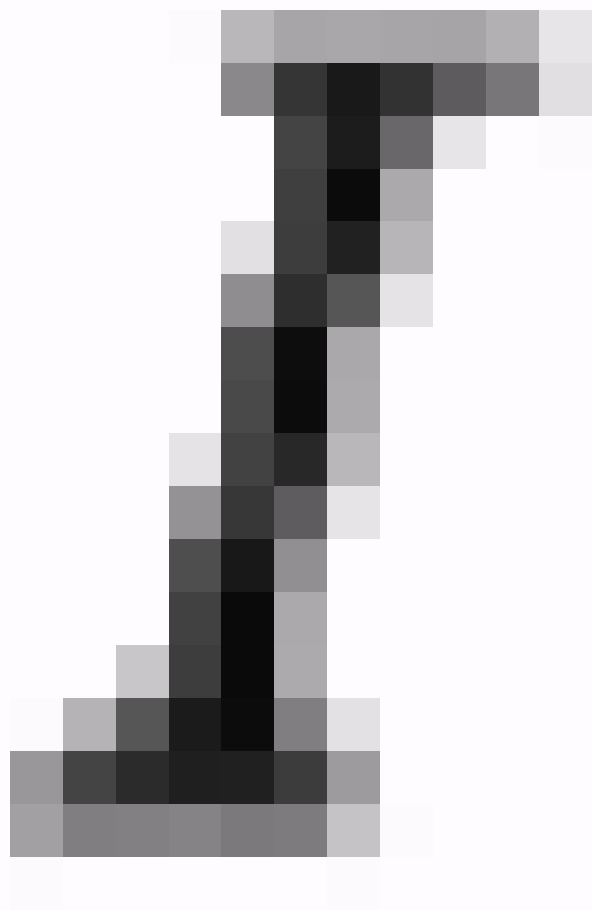

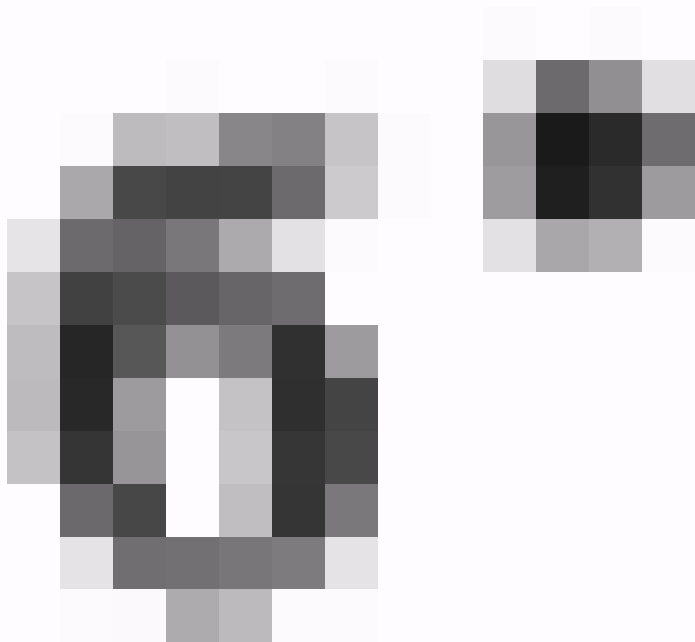
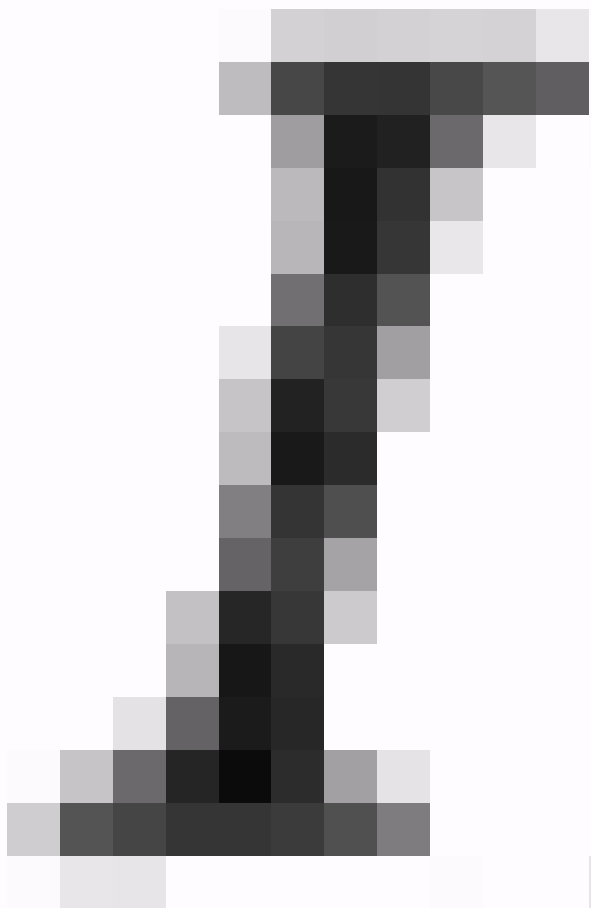

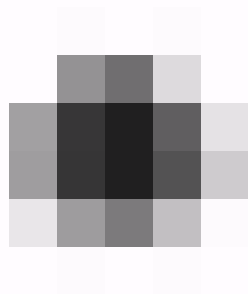
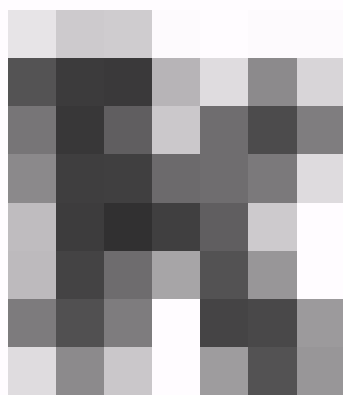
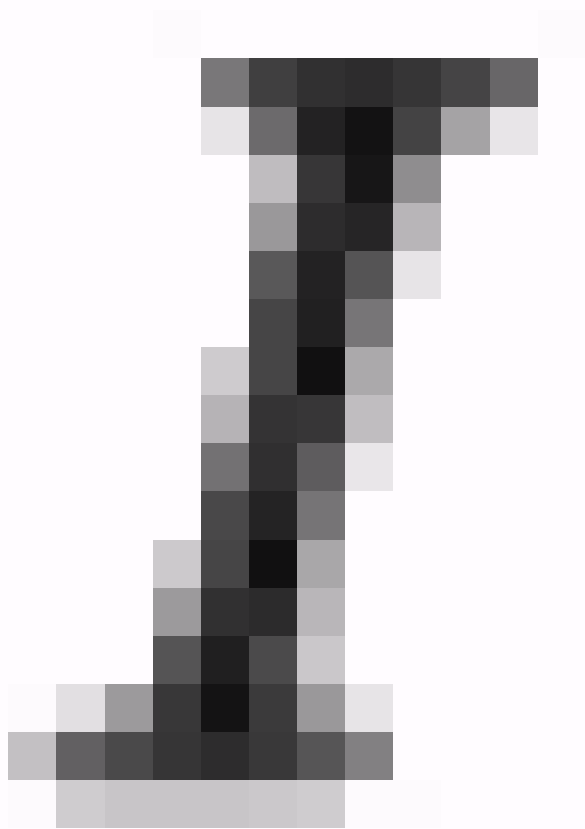

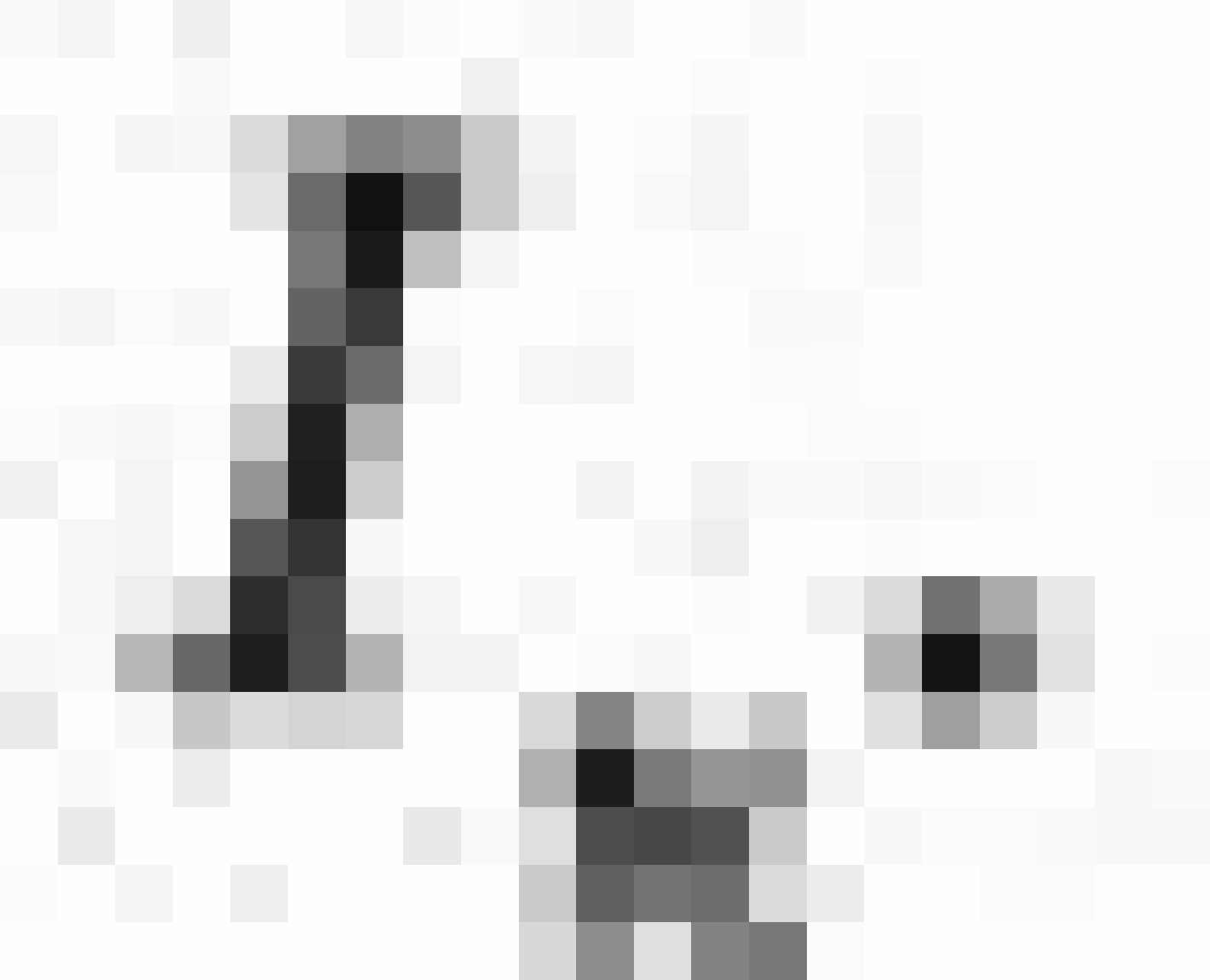

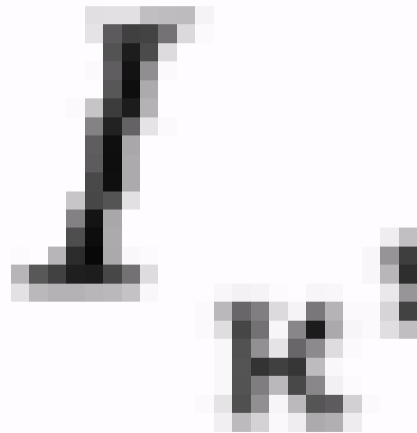
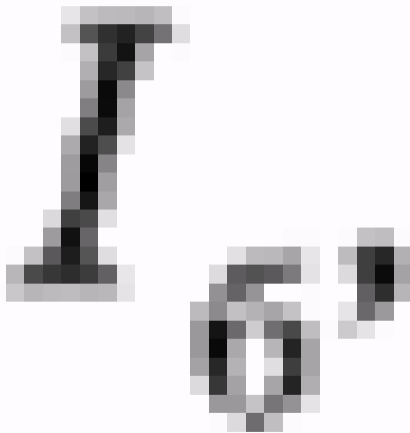
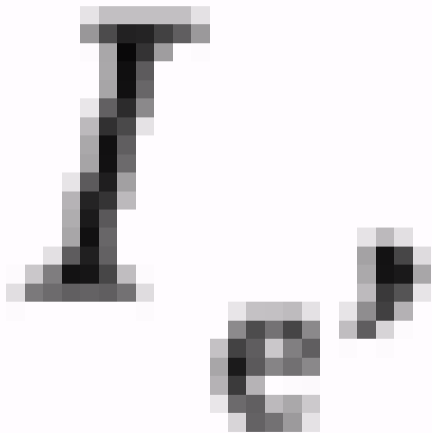

10

=

100

+

1000

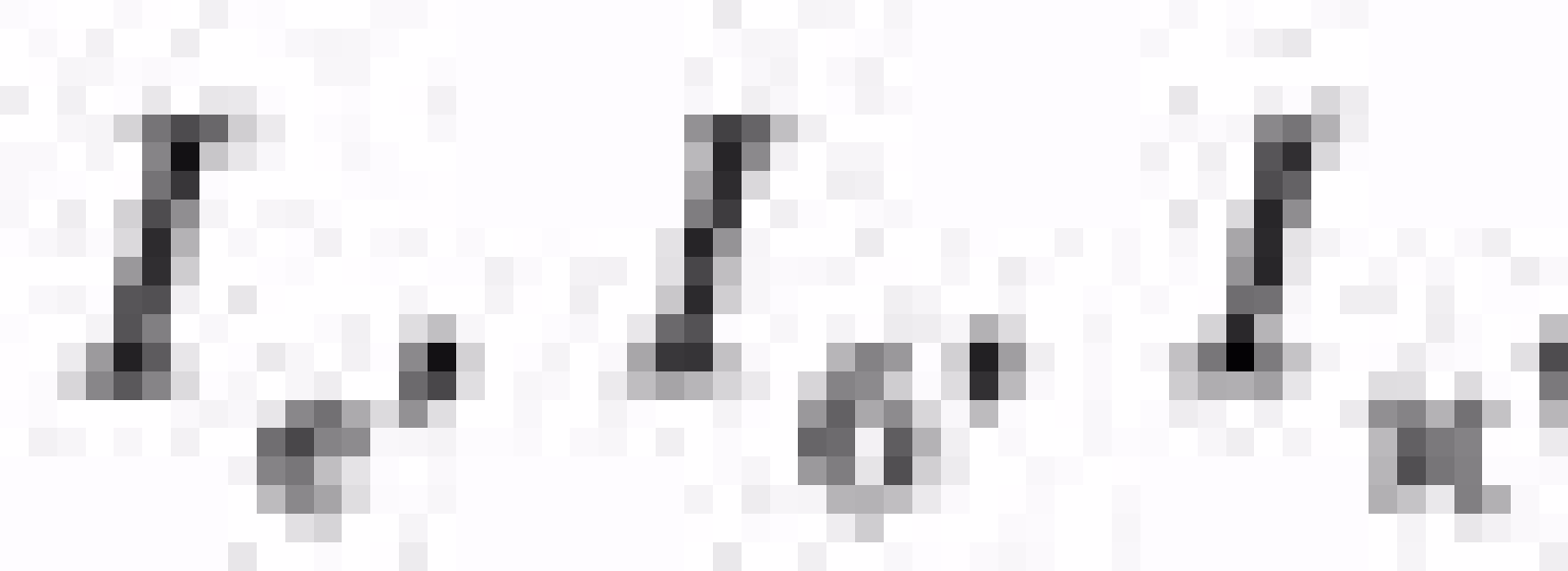

10

=

100

+

1000

$$\frac{I_k}{I_0} = \text{const},$$

$$\frac{I_k}{I_c} = \text{const}.$$



$$\frac{I_k}{I_0} = \text{const},$$

$$\frac{I_k}{I_c} = \text{const}.$$

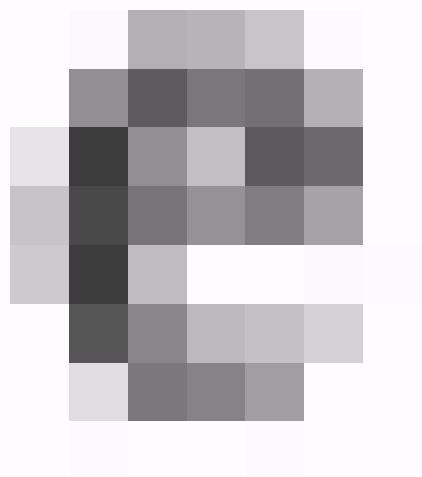
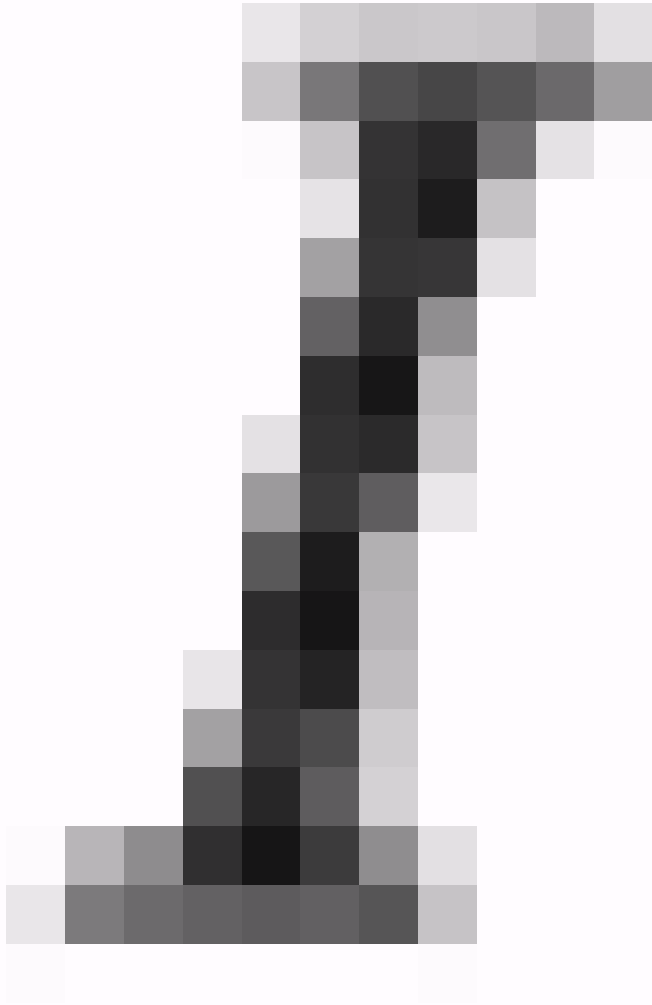



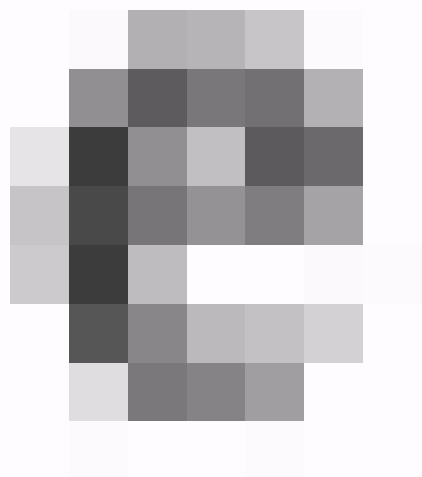
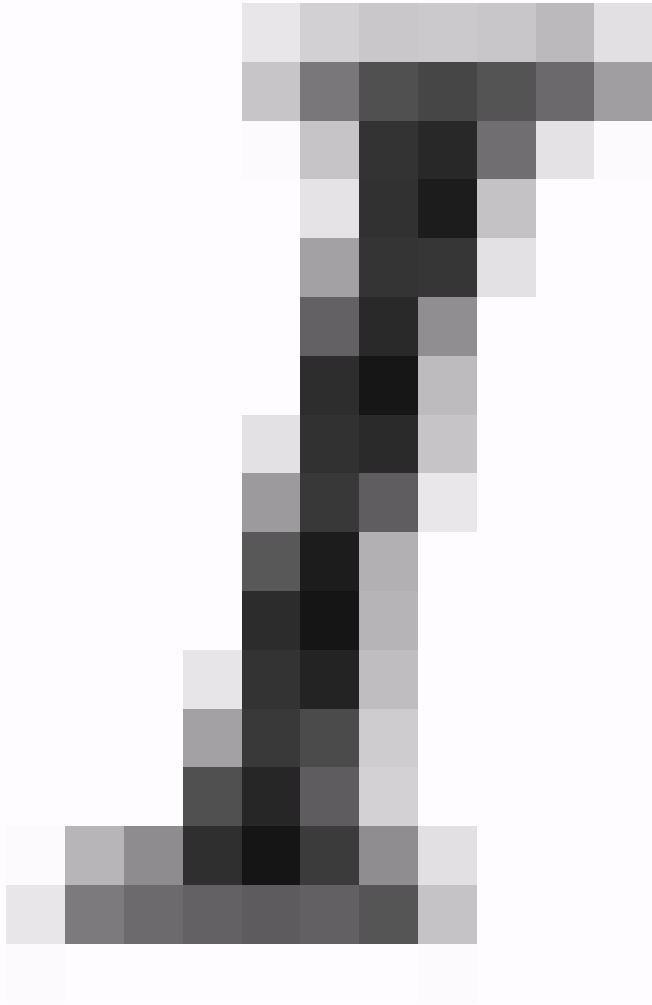

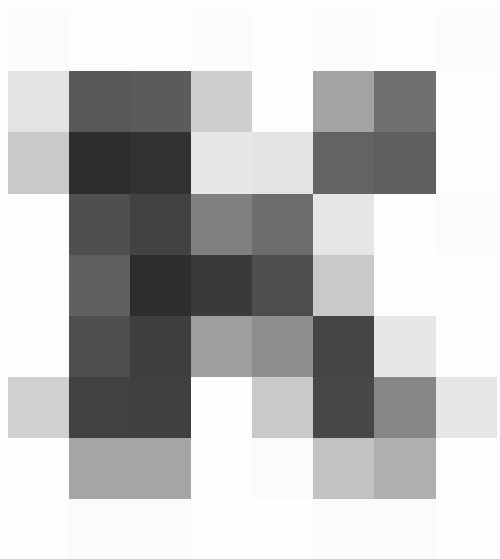
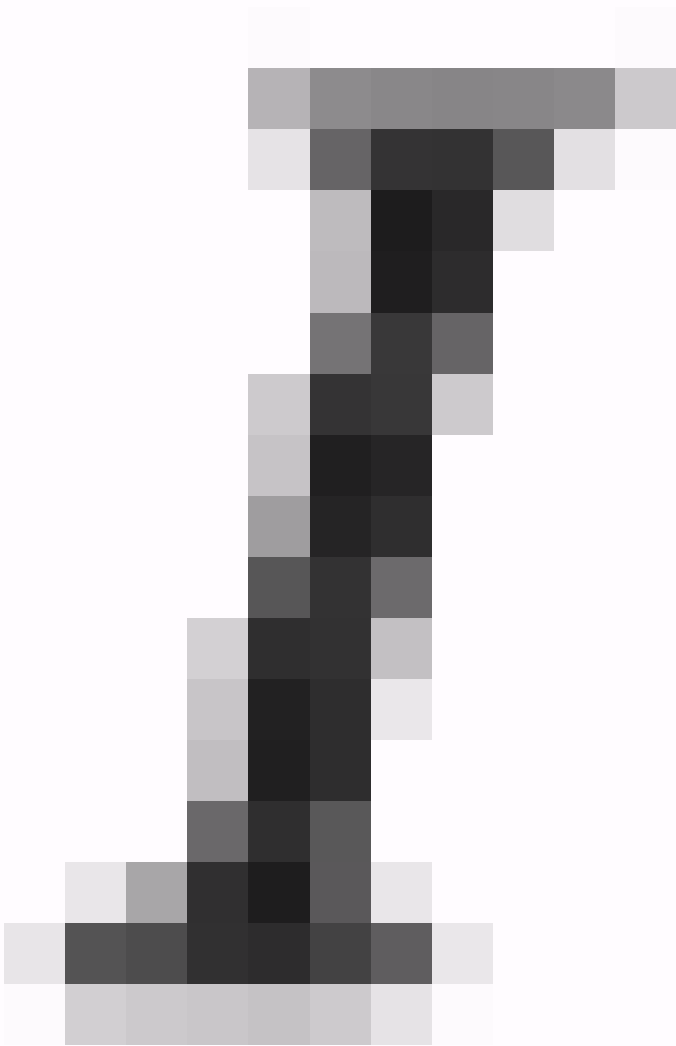

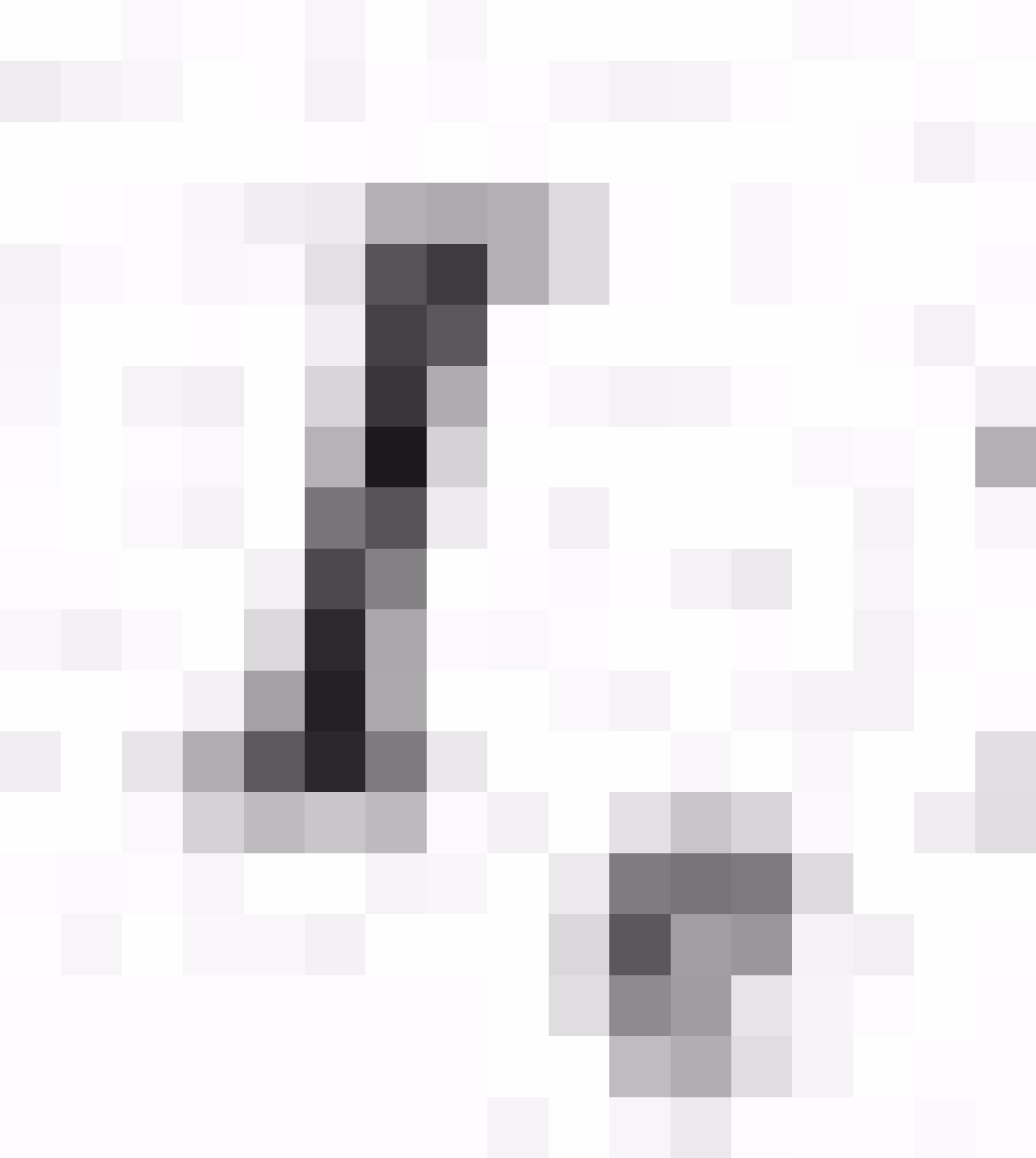

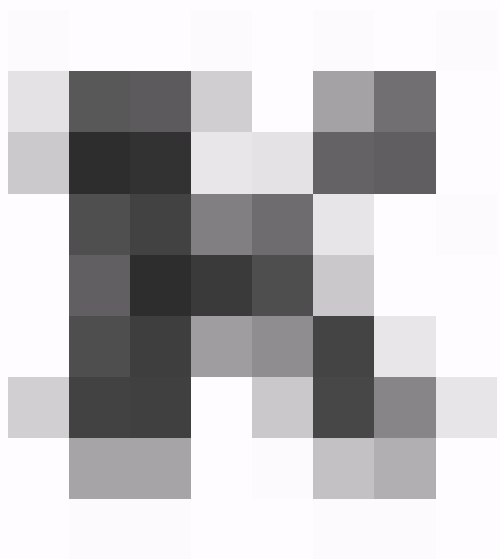
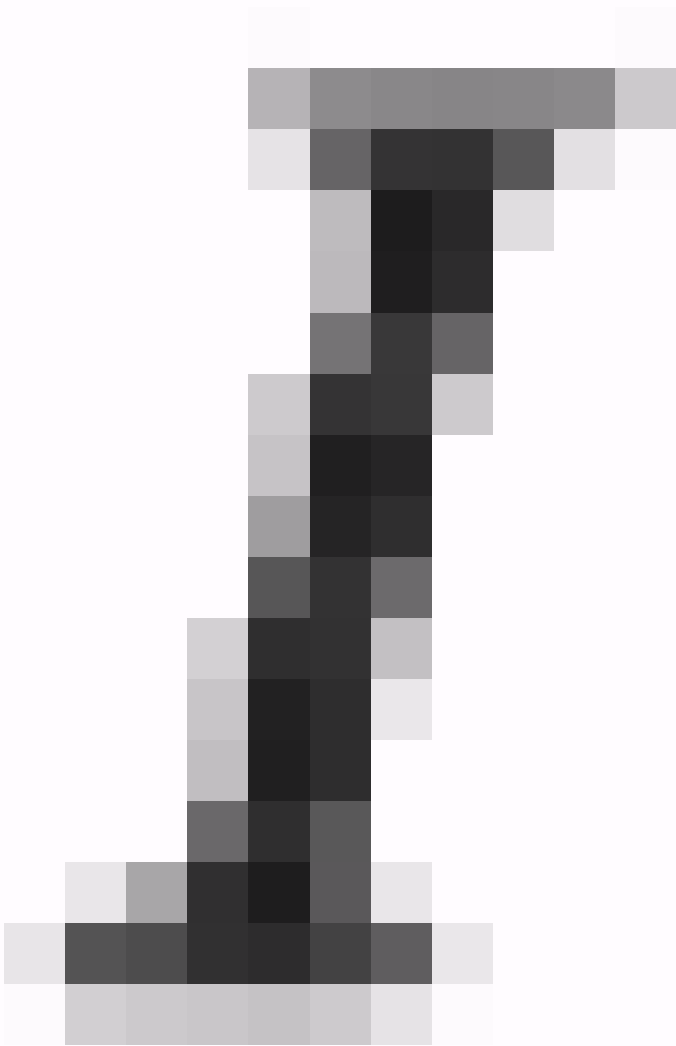

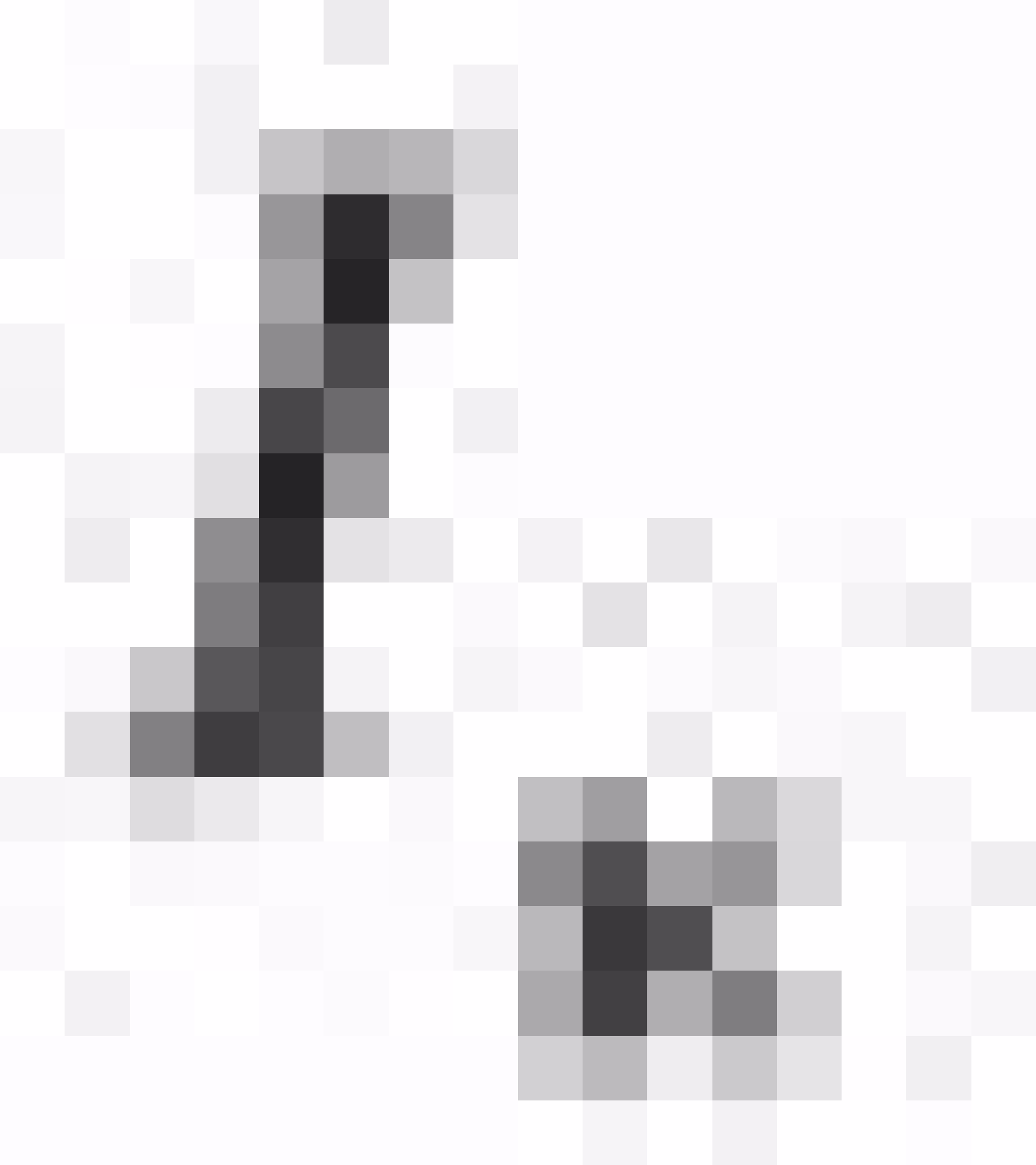

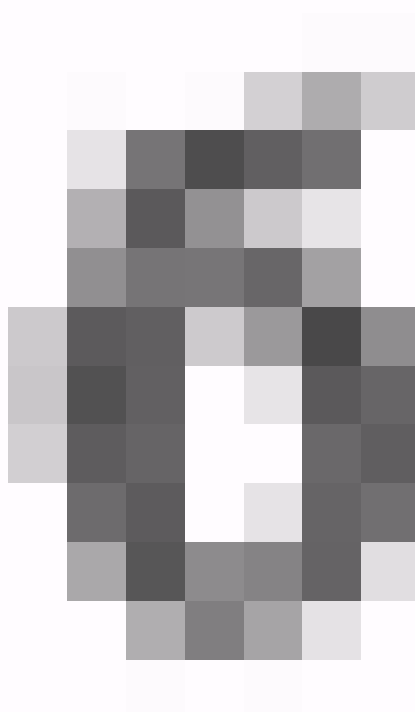
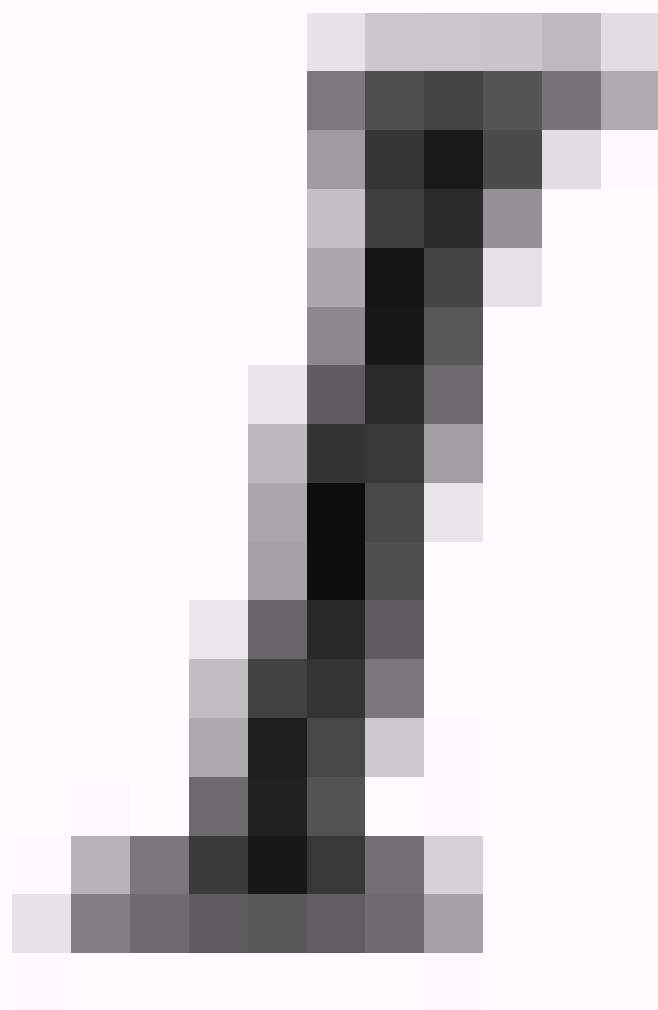

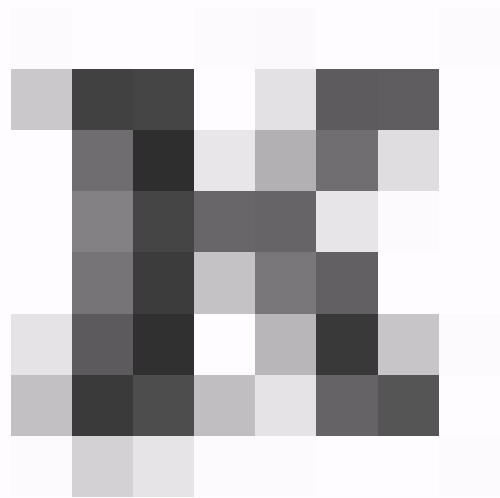
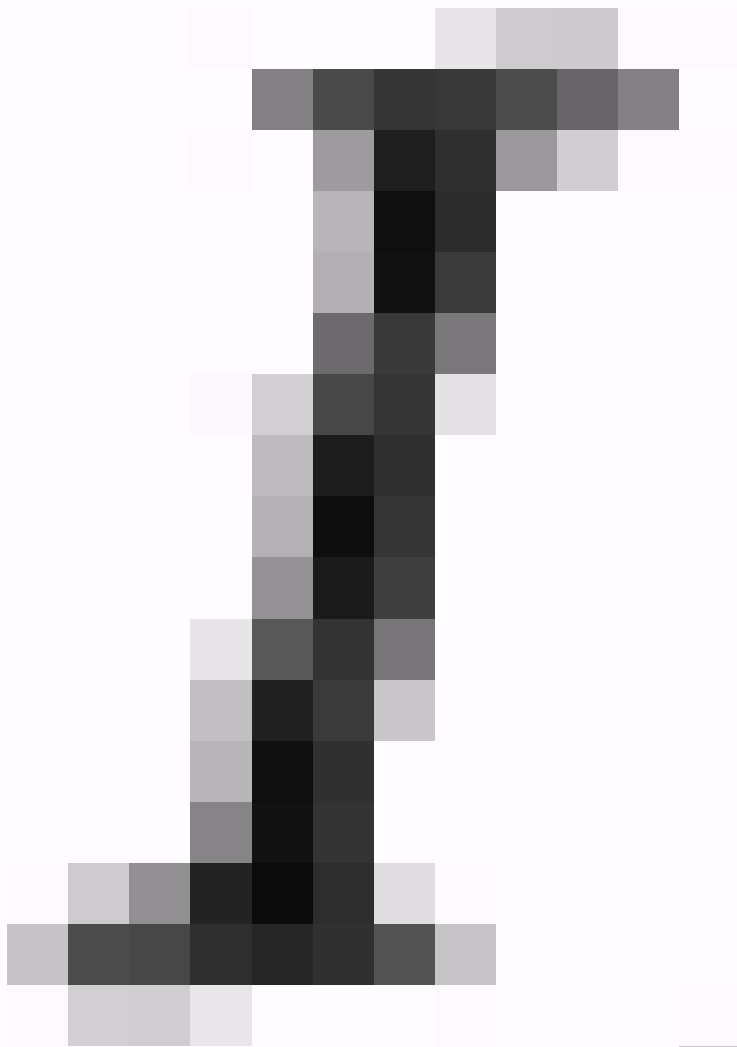

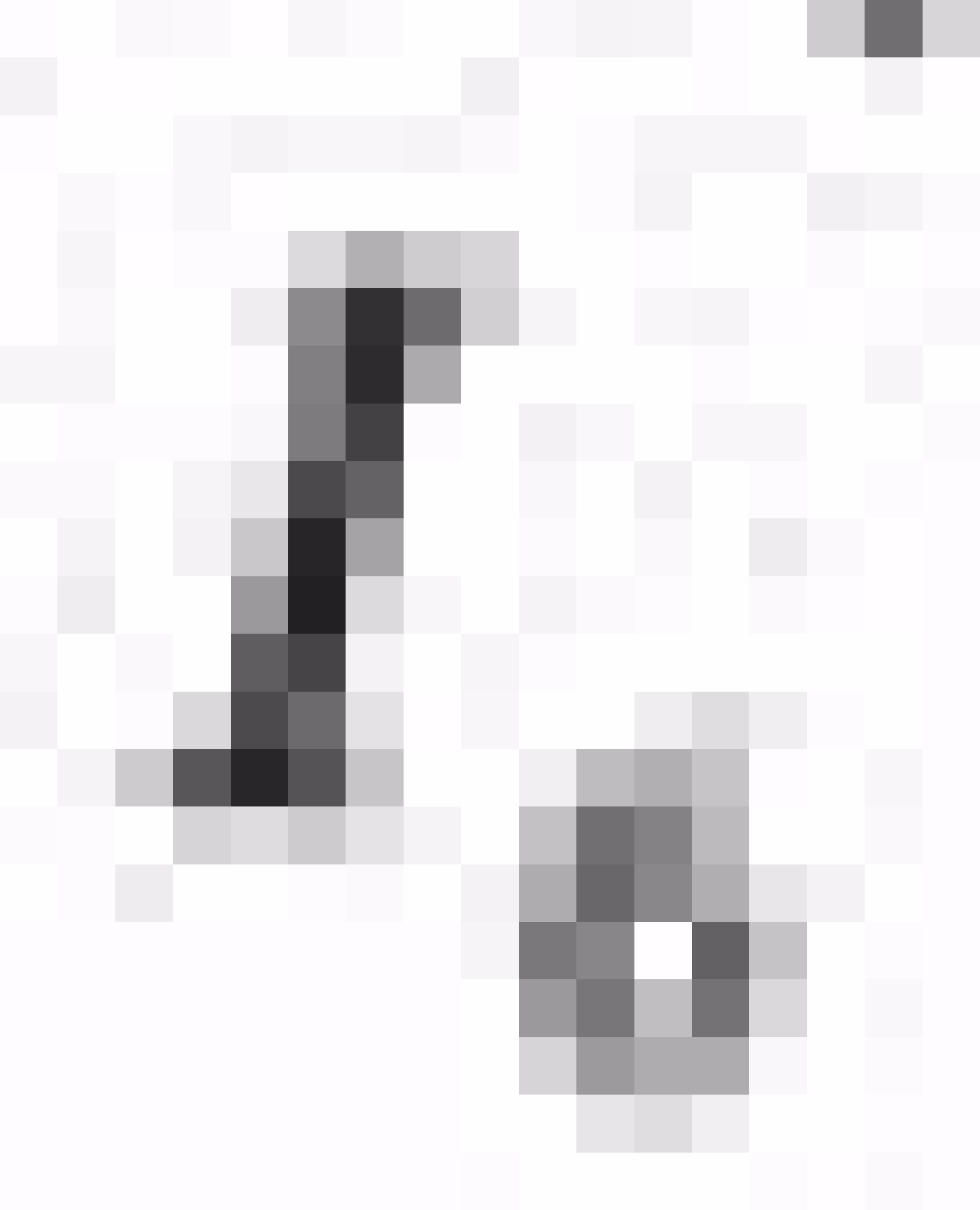

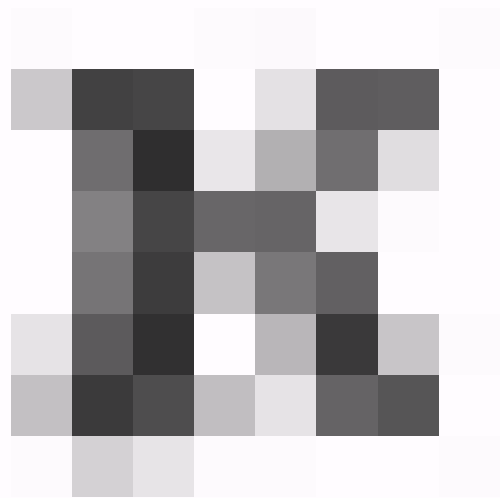
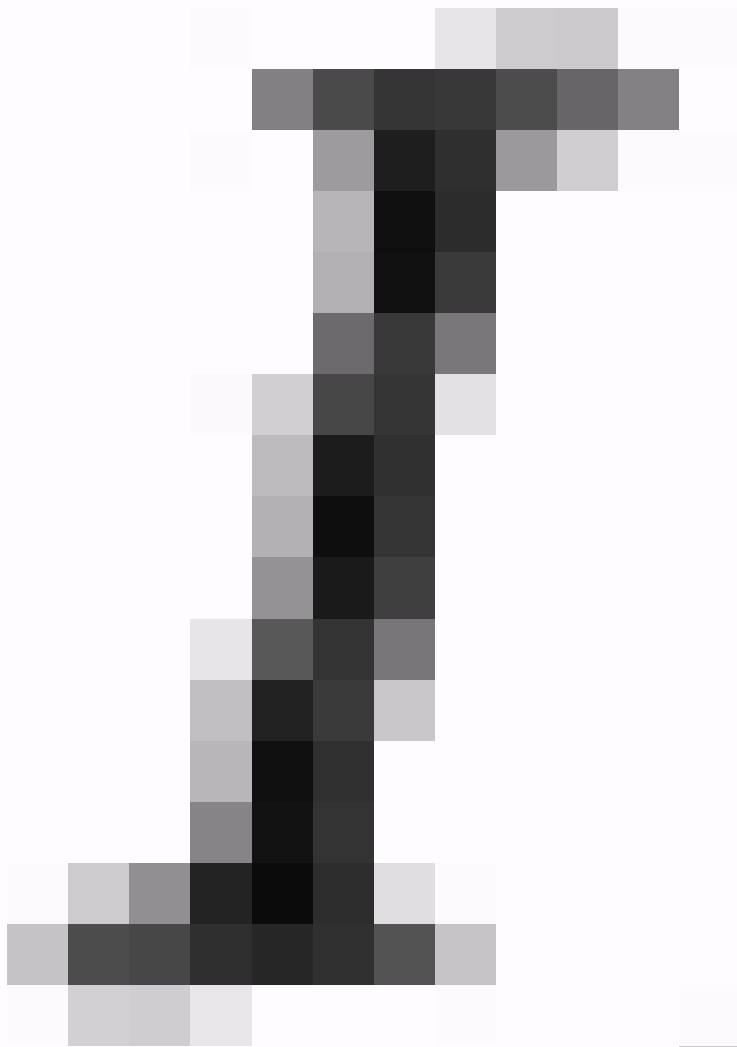

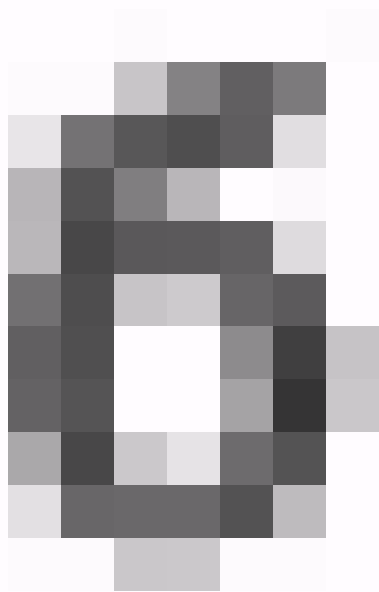
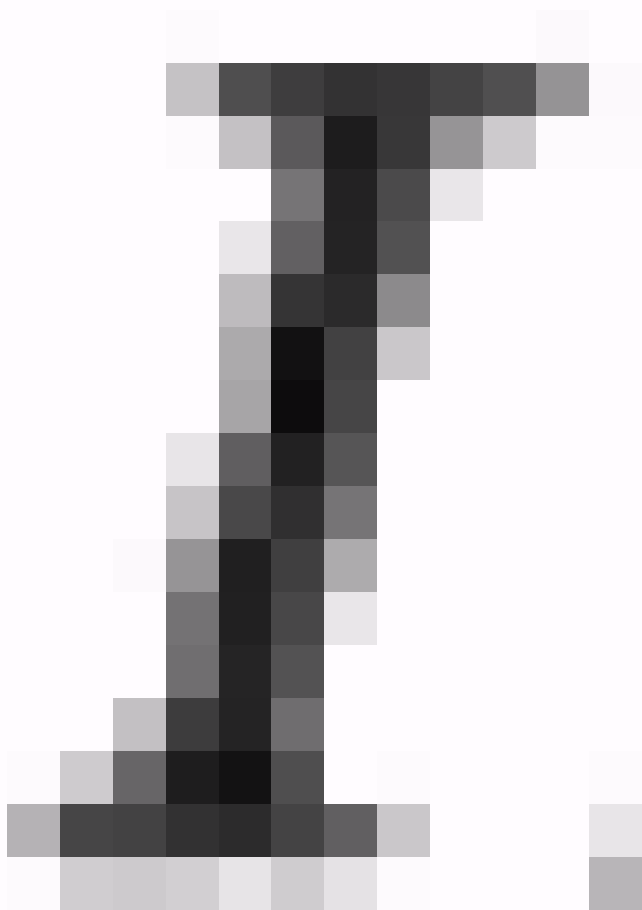

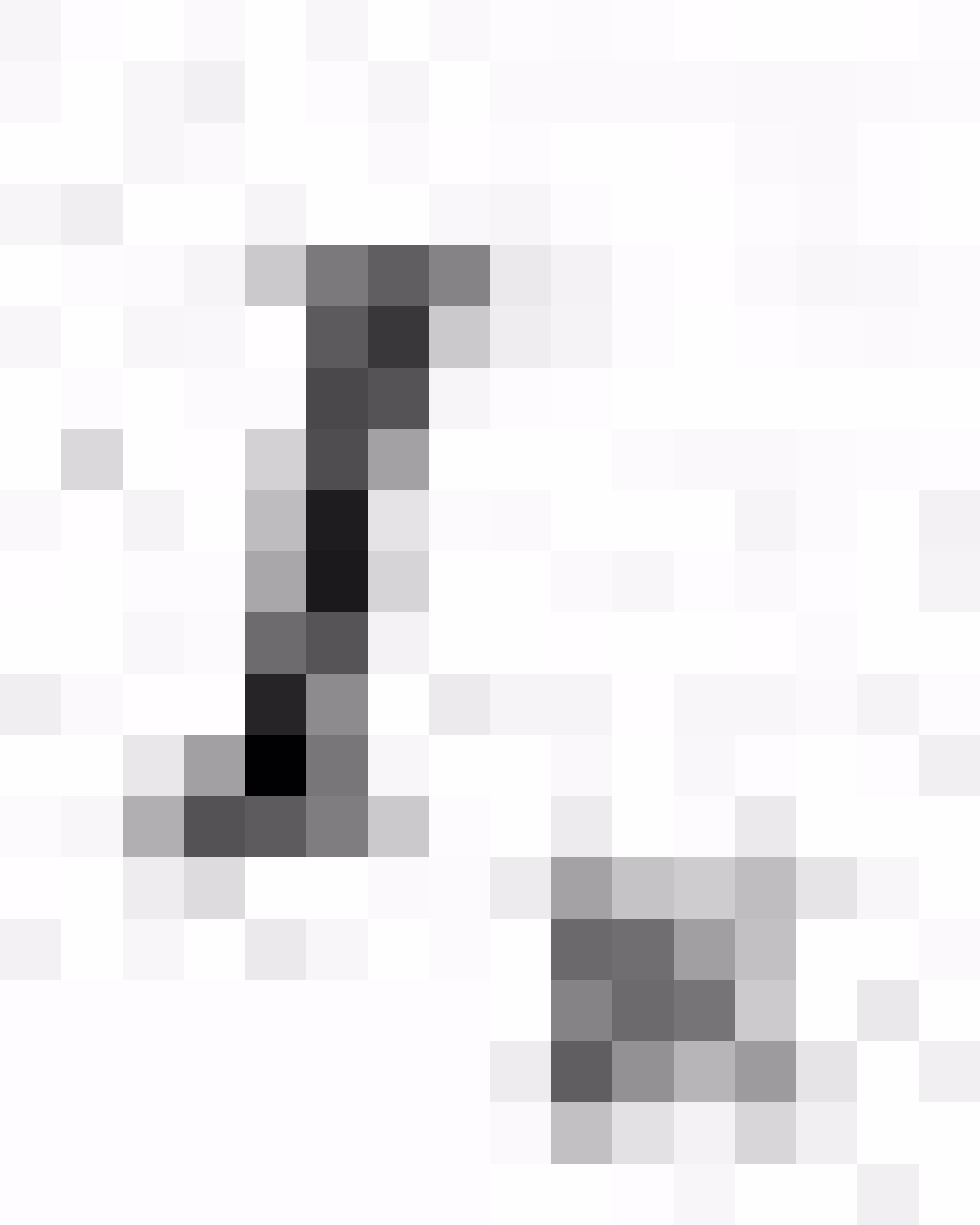

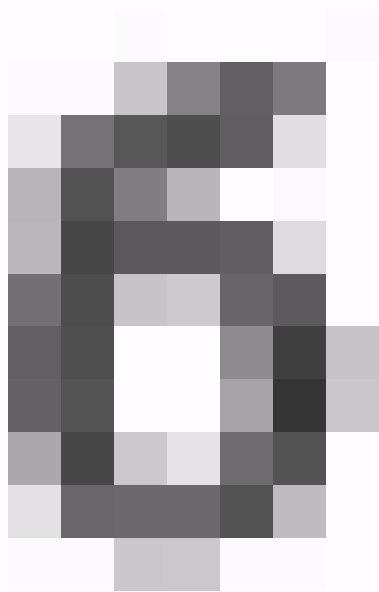
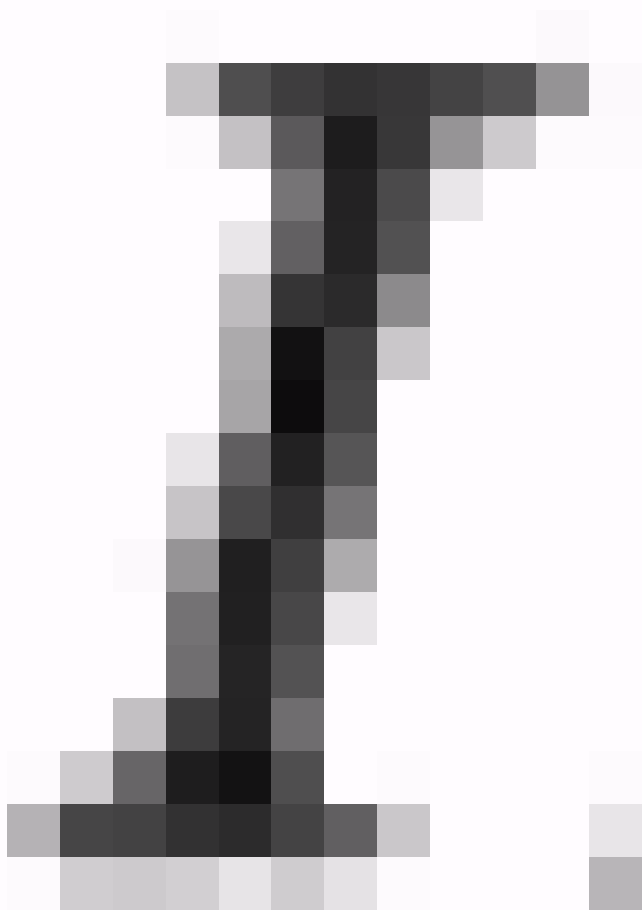







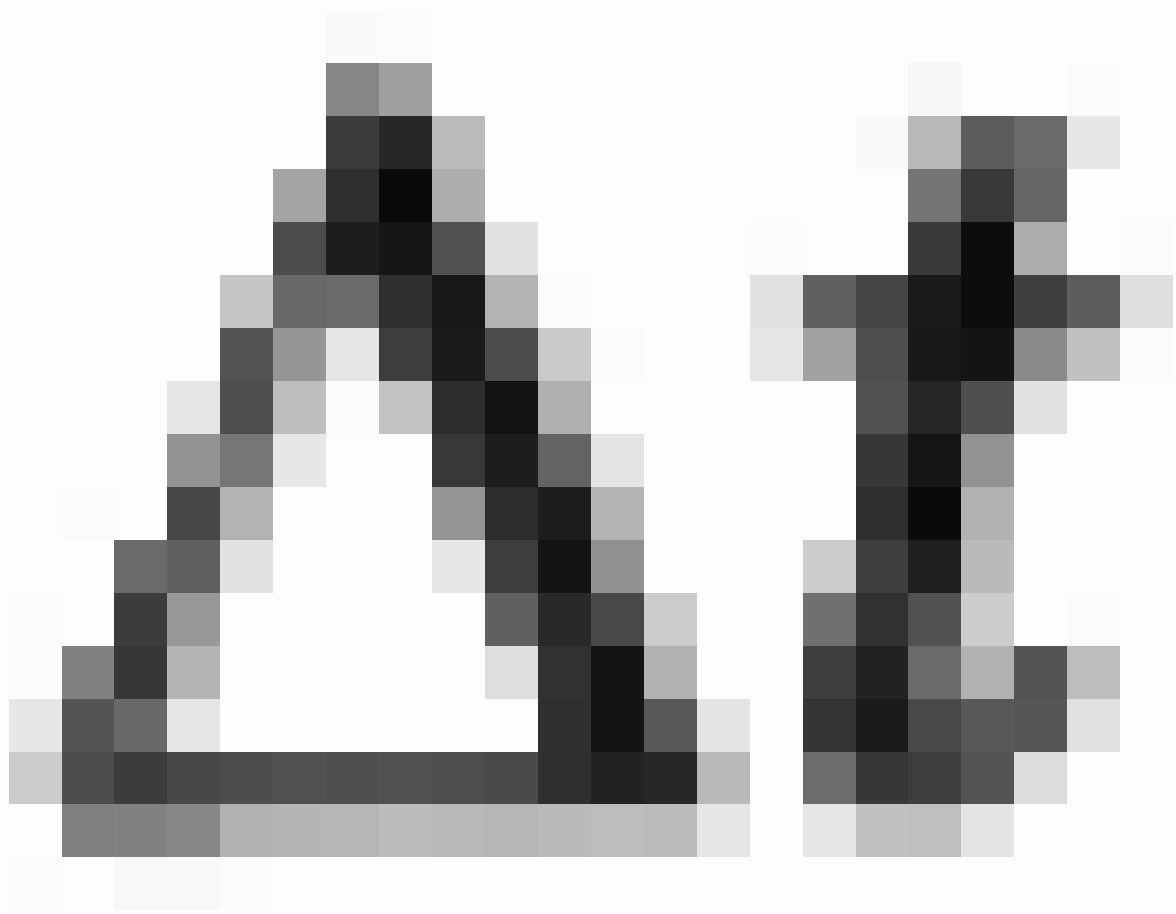

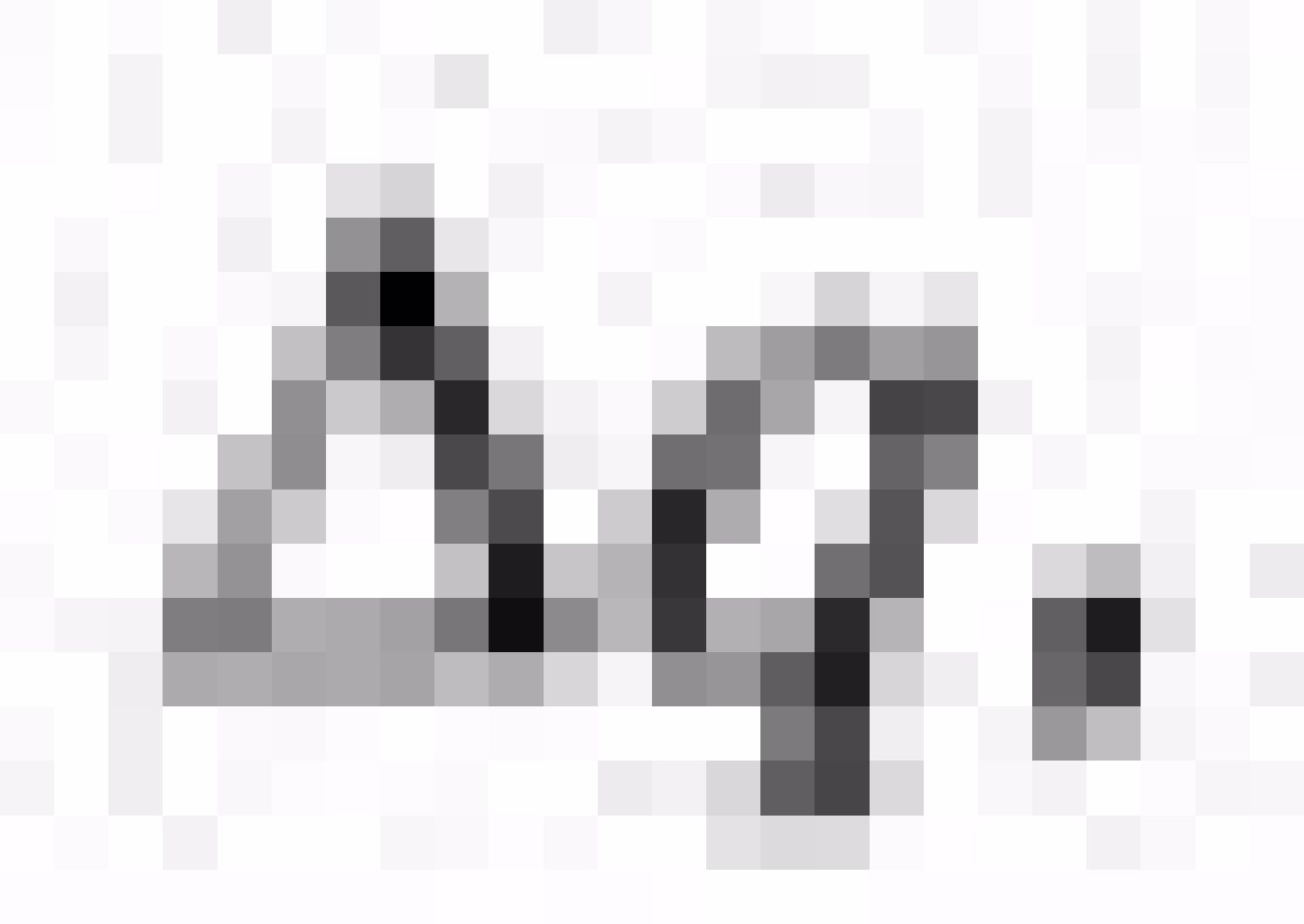

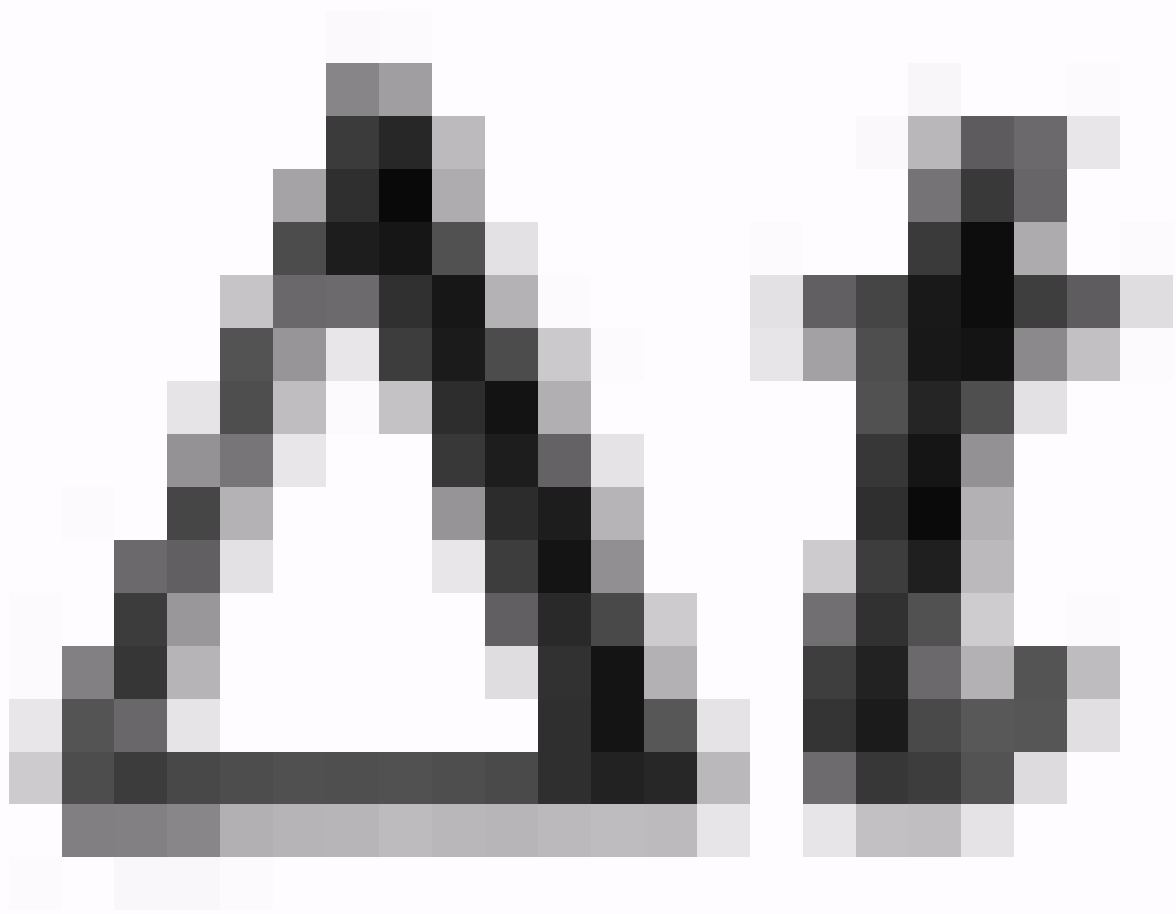

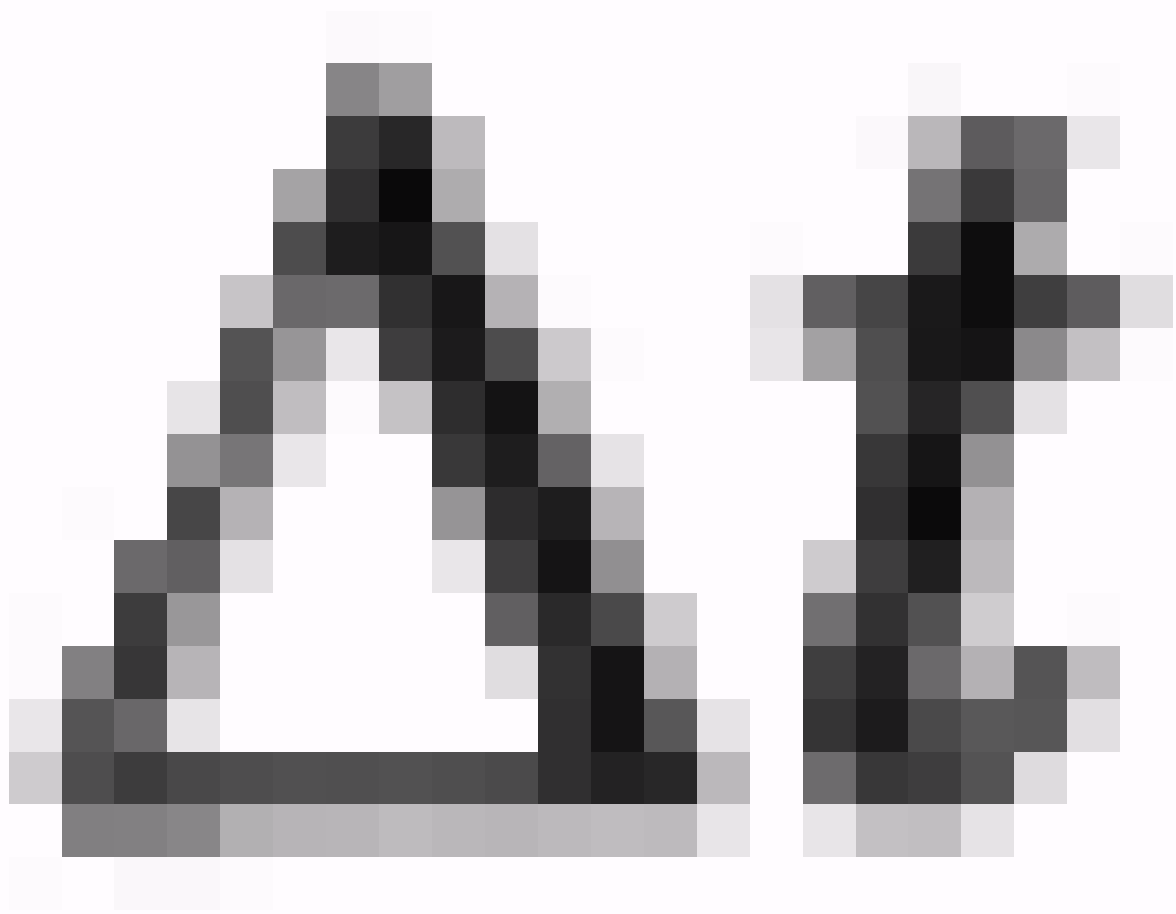

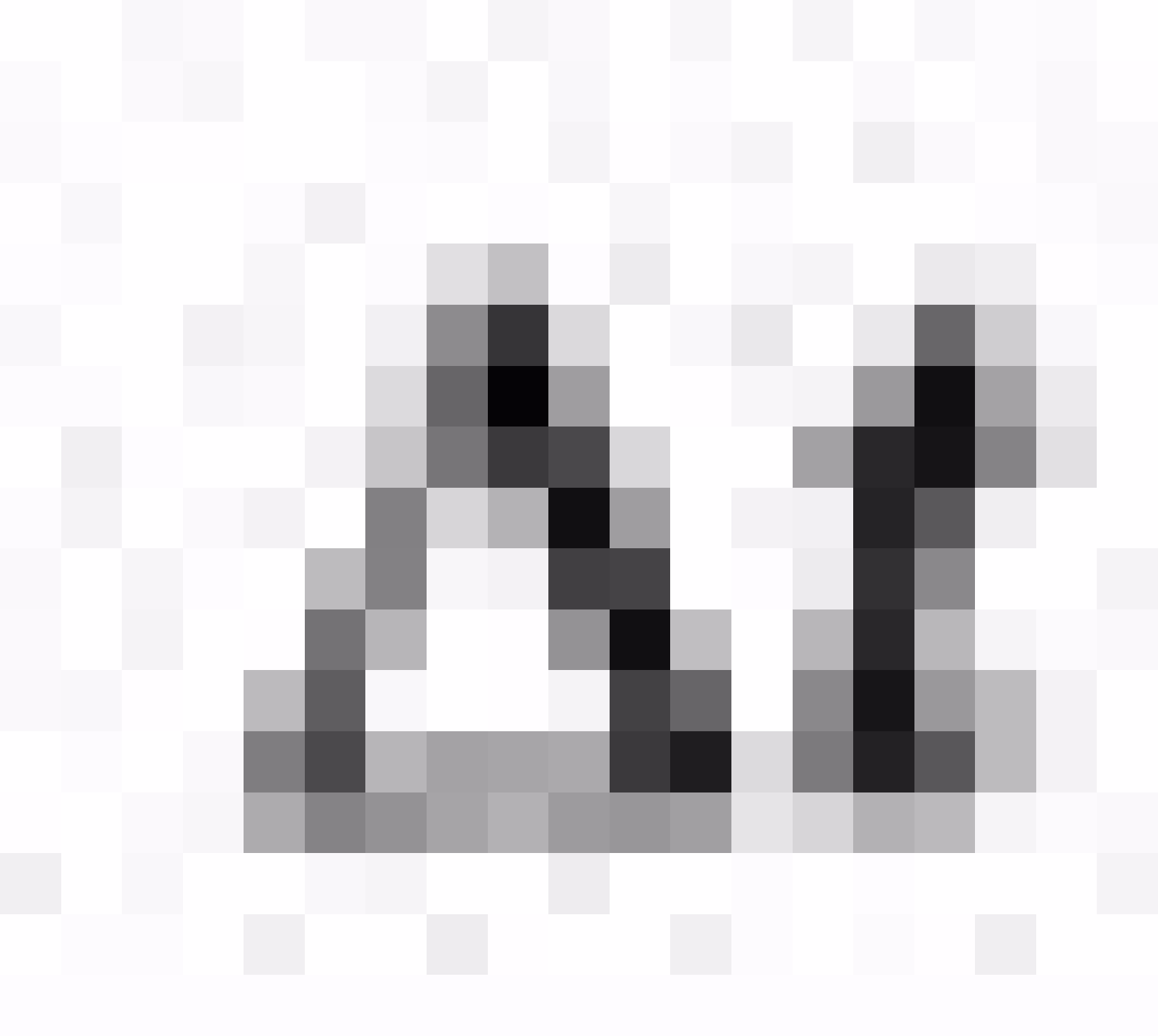

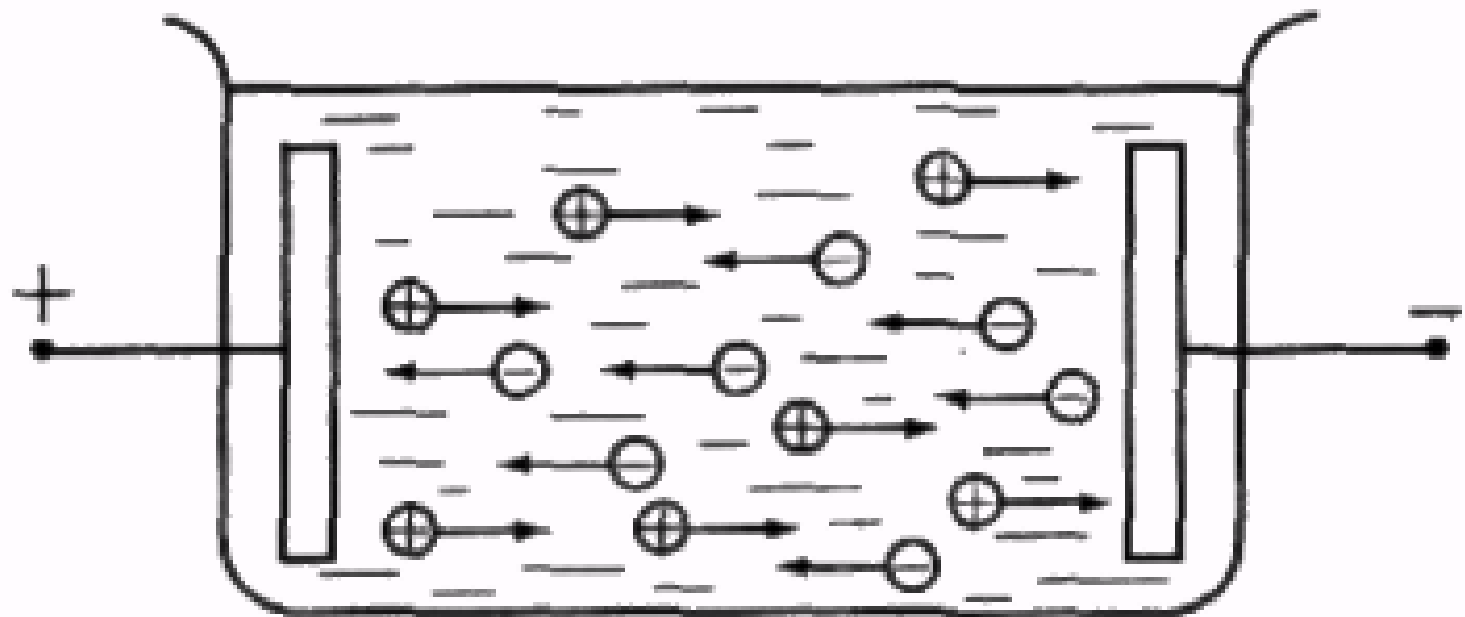

Мал. 2.132



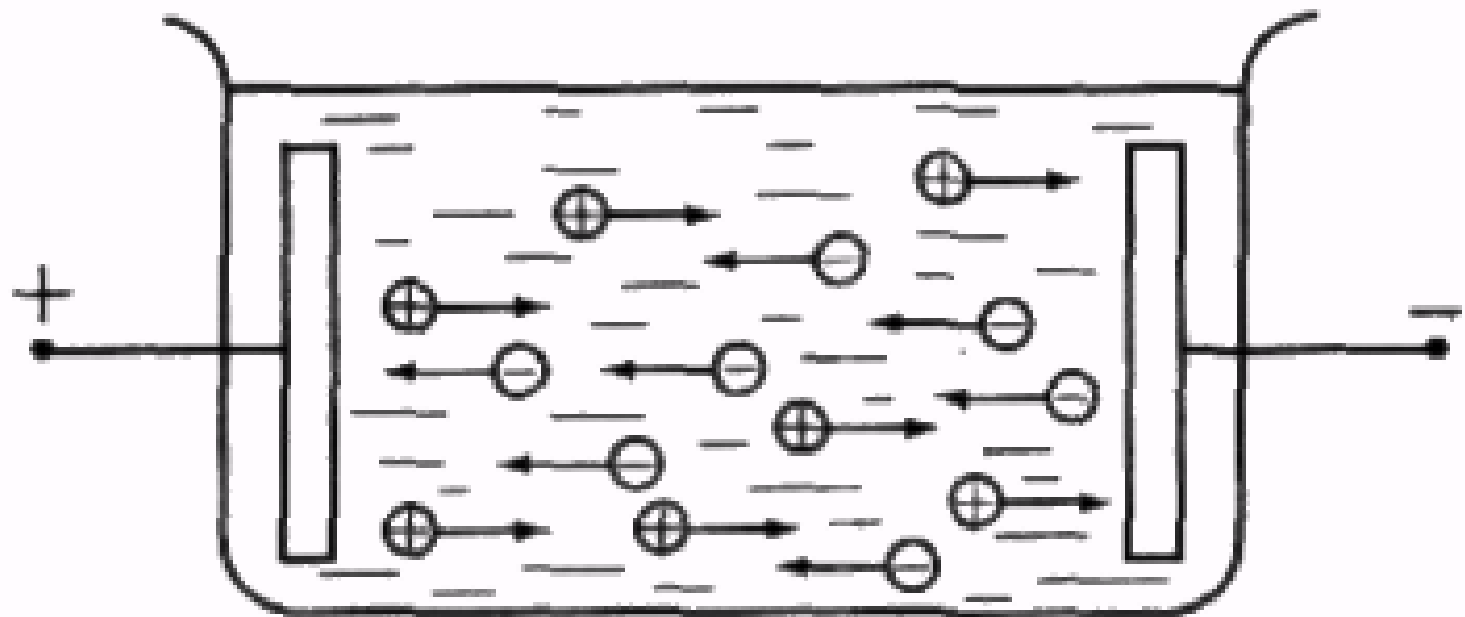

Мал. 2.132

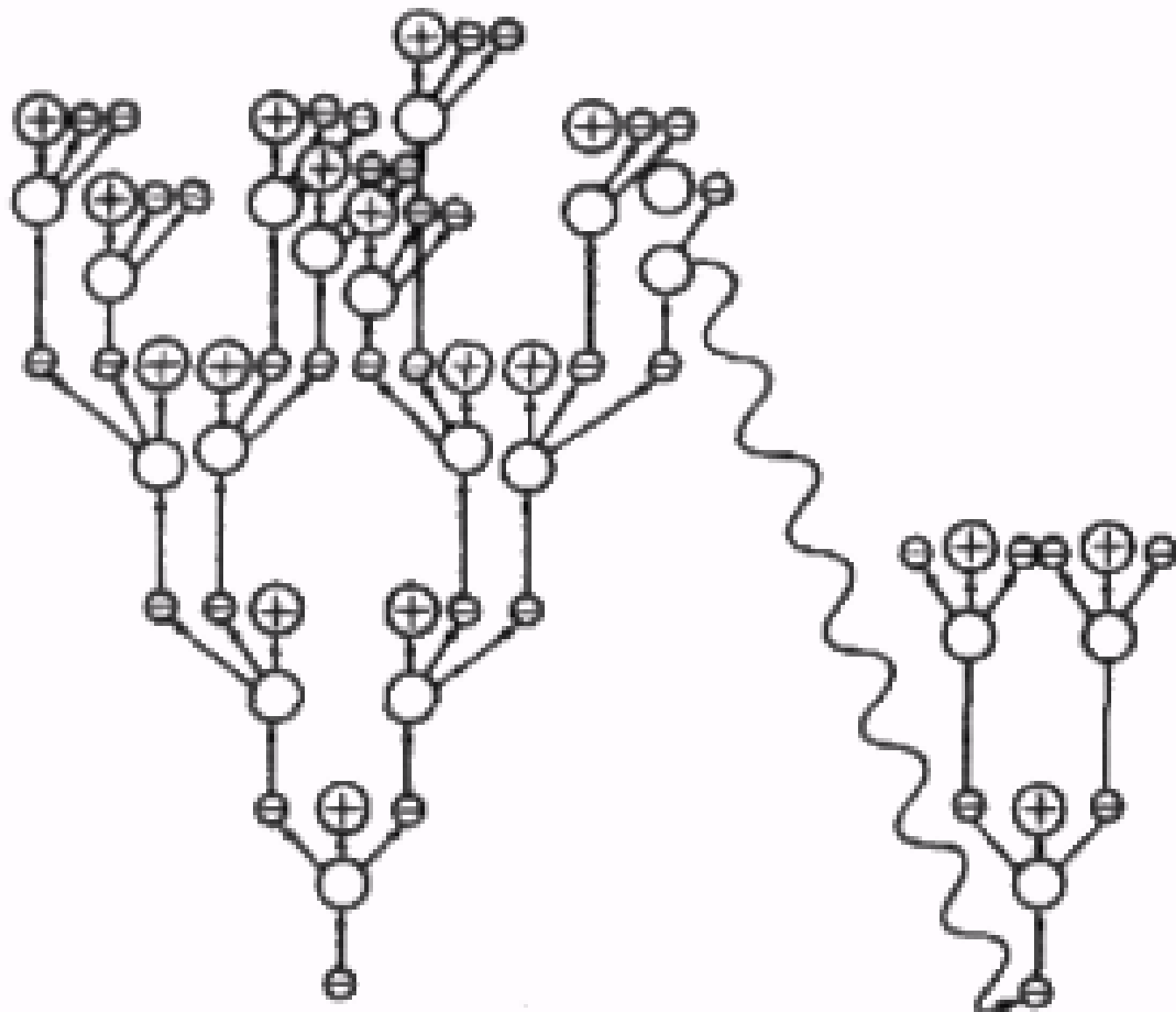

Мал. 2.133

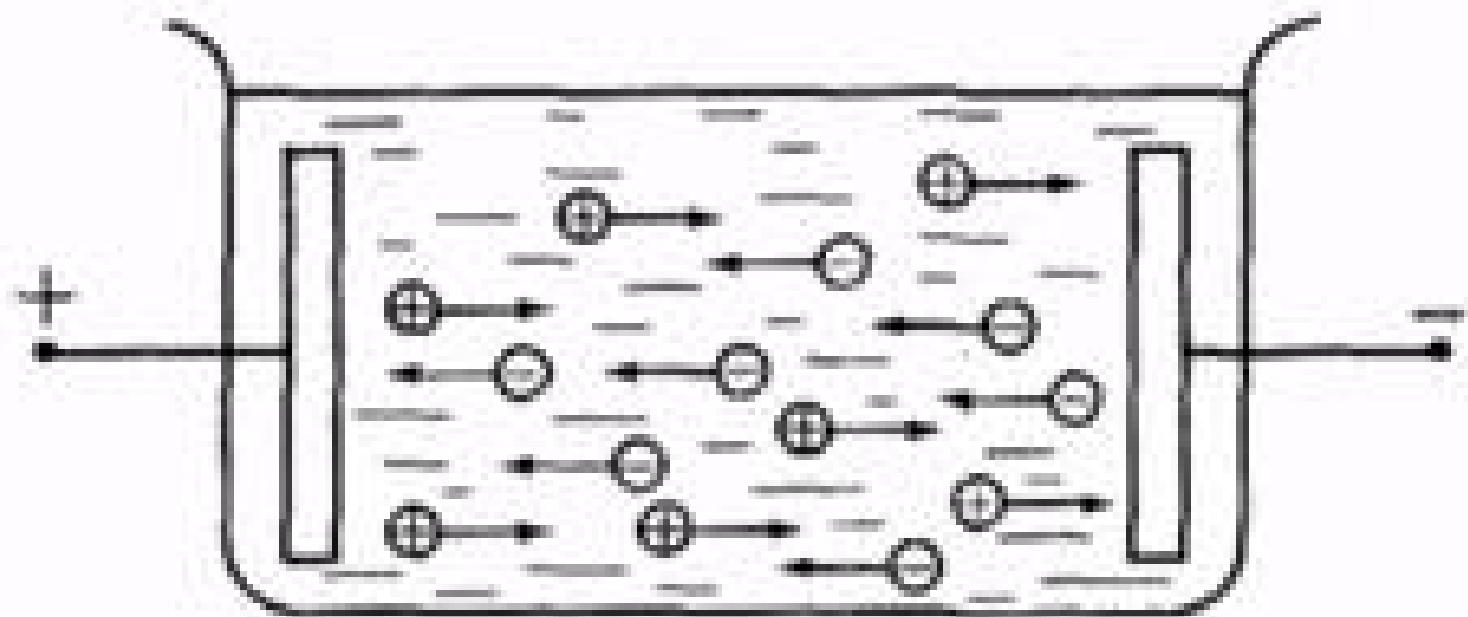

Мал. 2.132

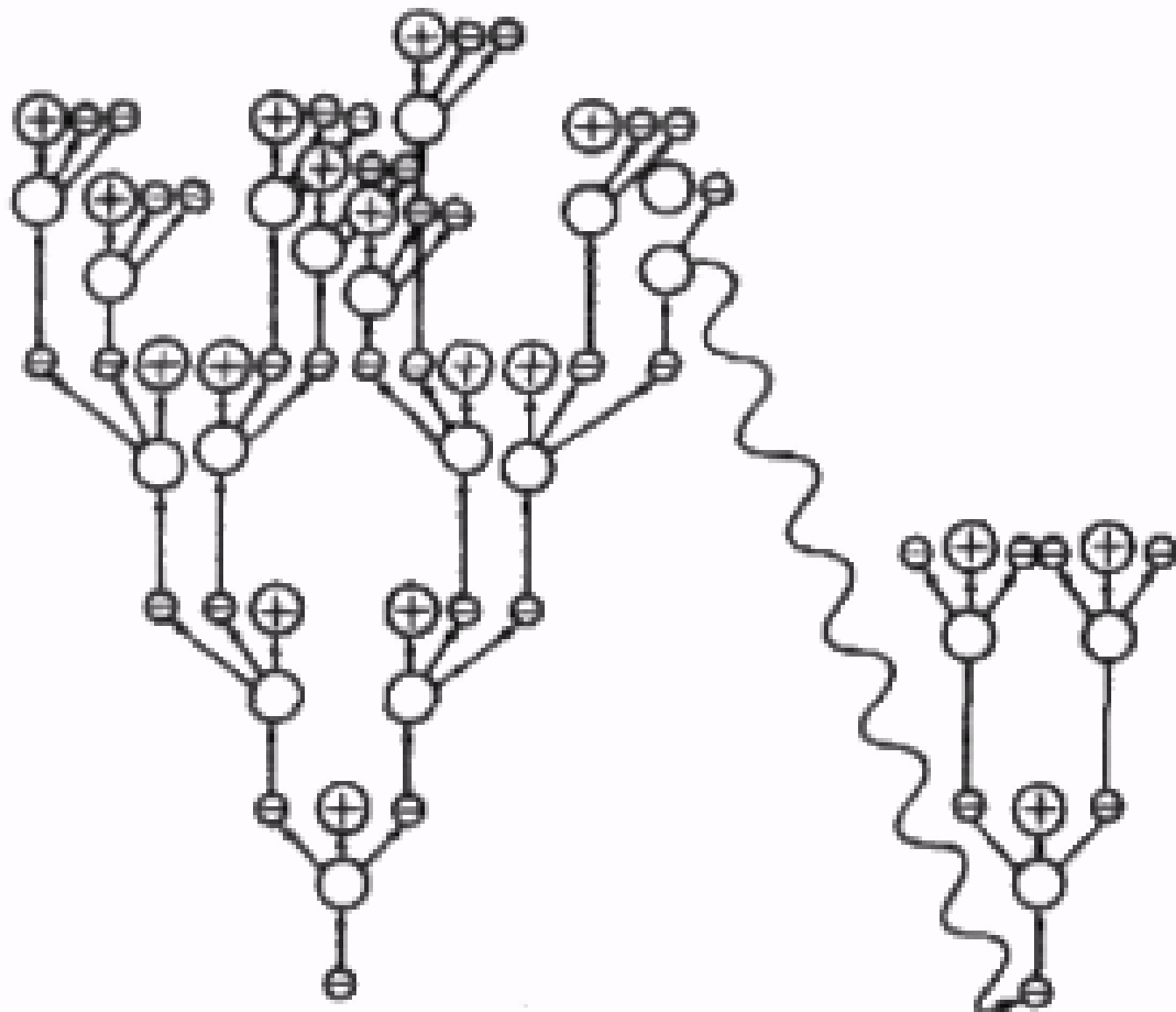

Мал. 2.133

1000

1000

00

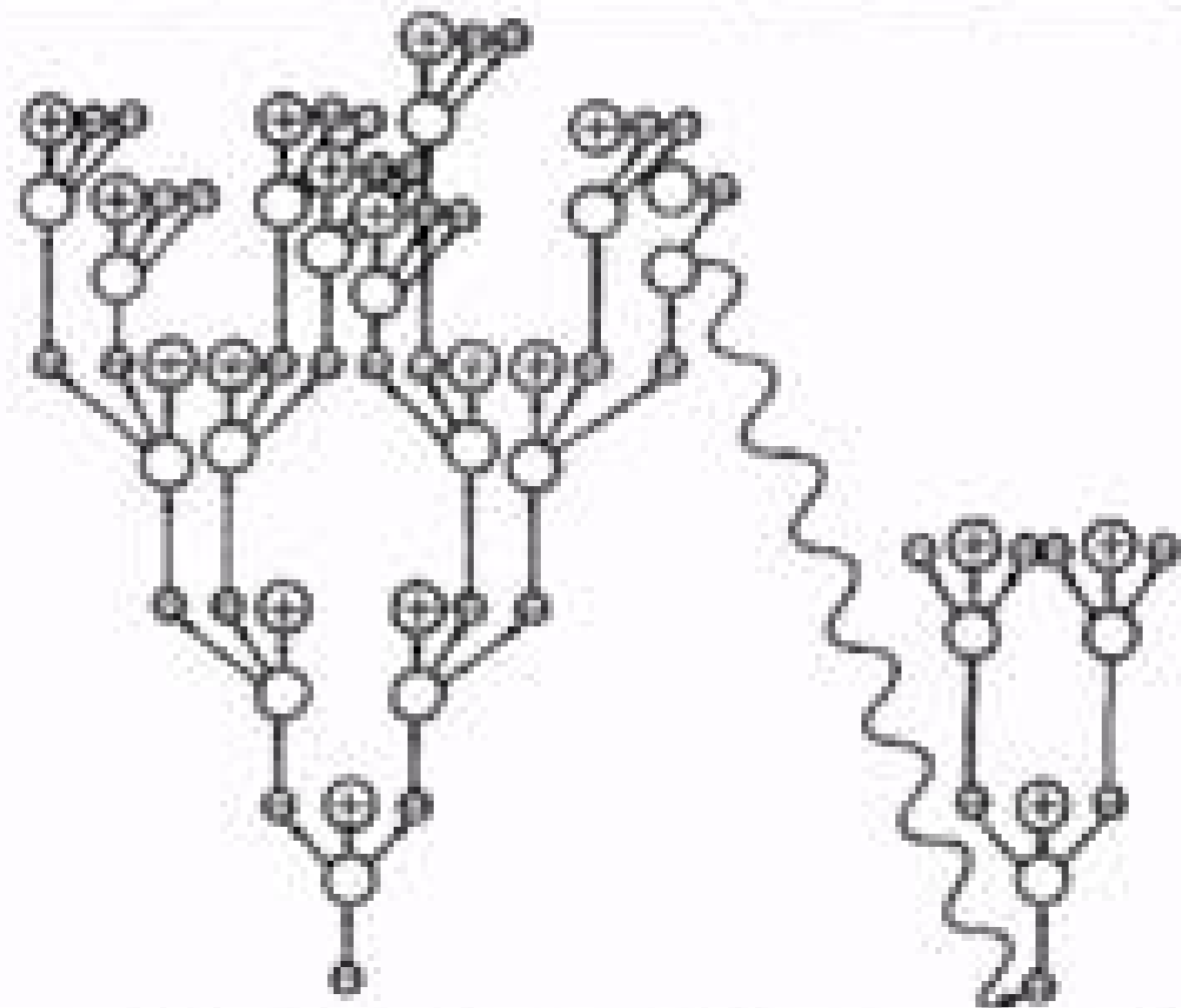

Мал. 2.133

1000

1000

00

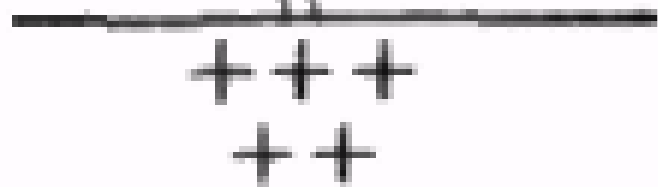
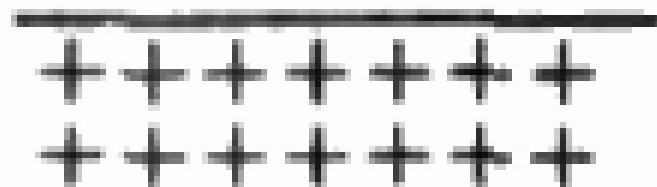

Мал. 2.134

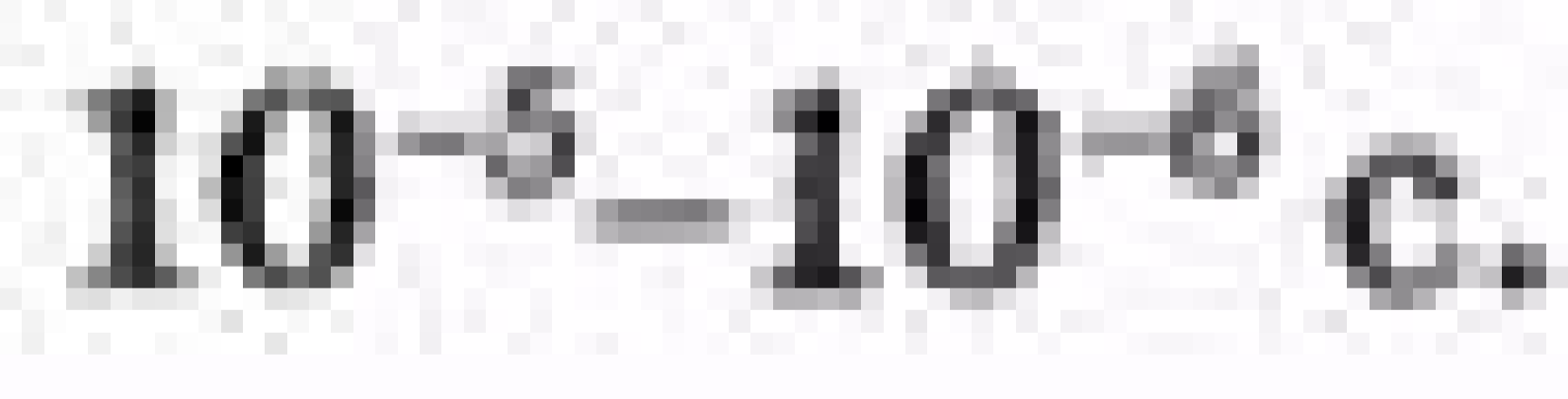

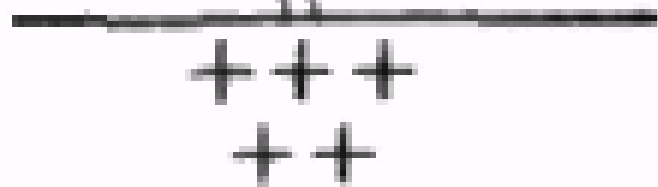
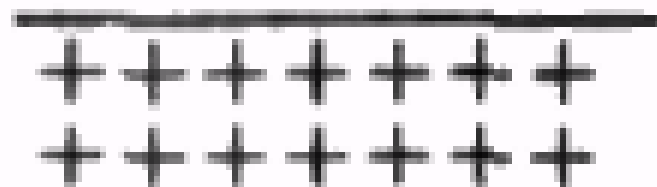

Мал. 2.134

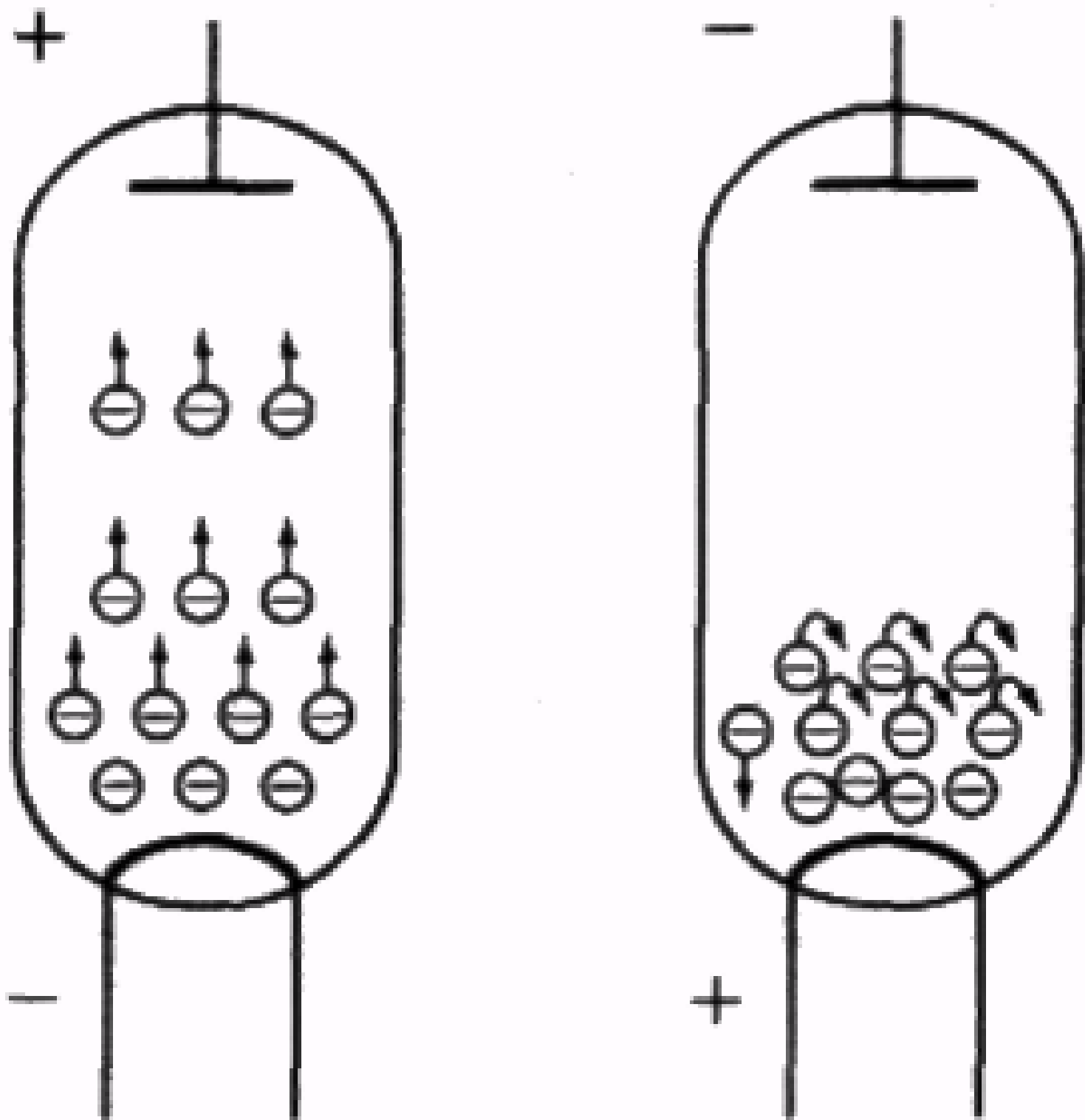

Мал. 2.135



++++++
++++++

+++
++

Mal. 2.134

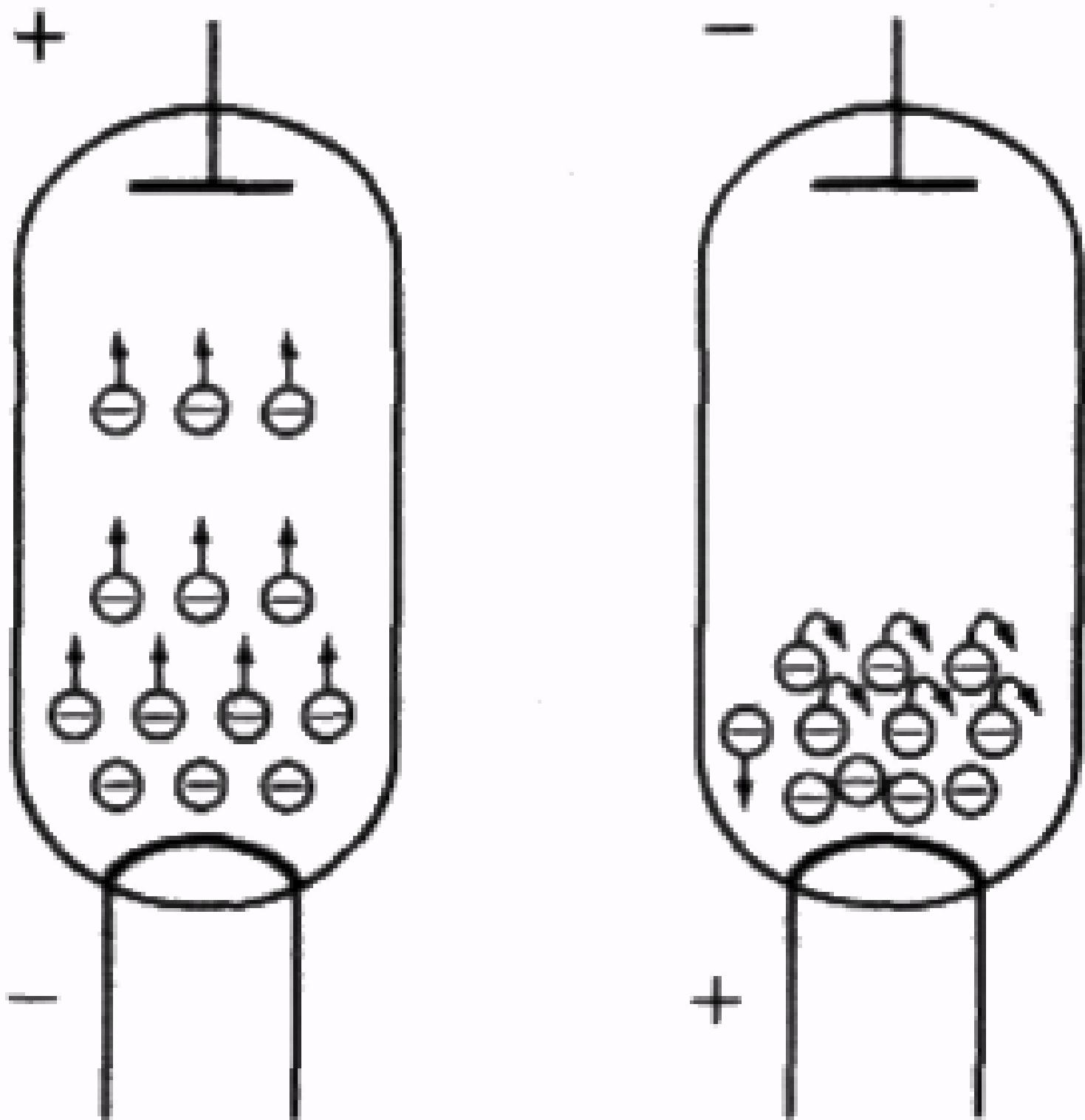

Мал. 2.135

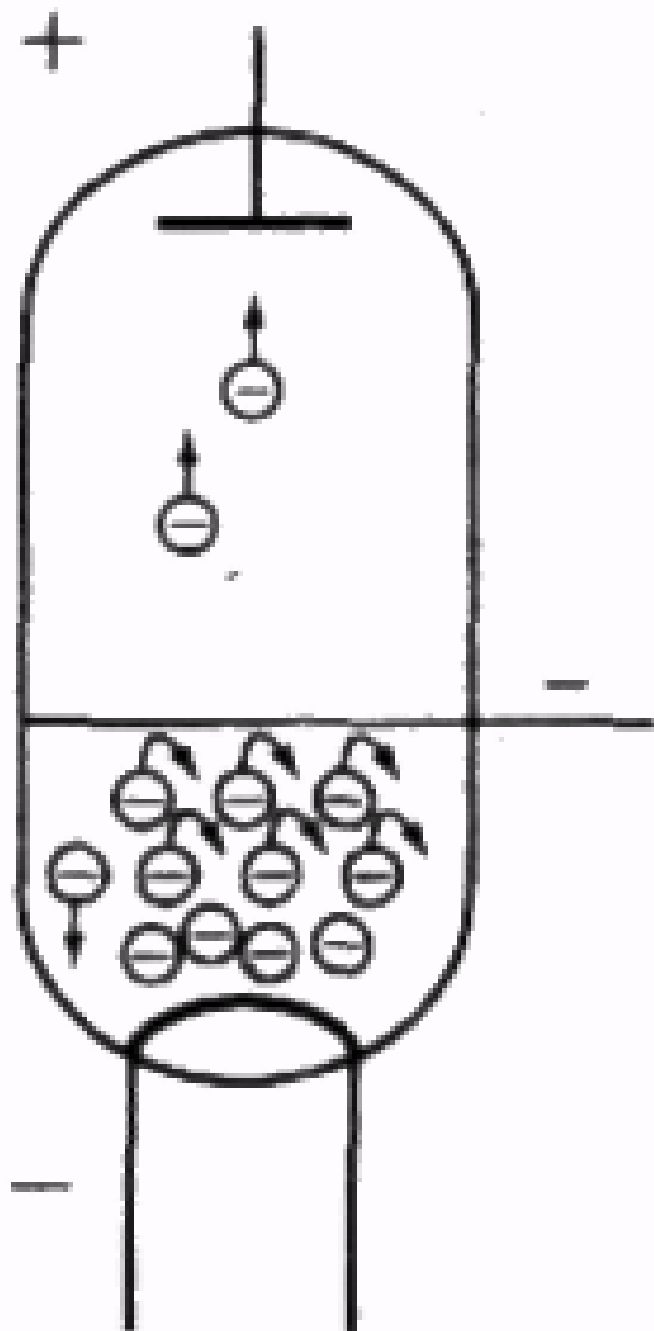
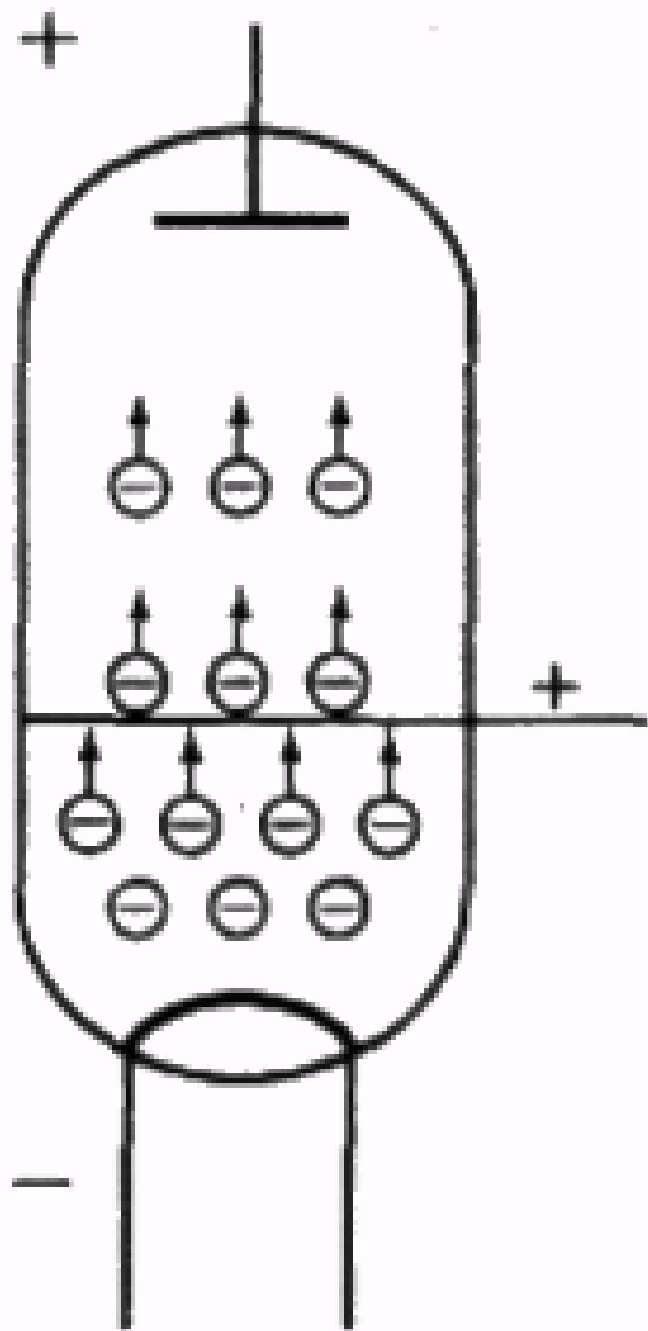

Мал. 2.136

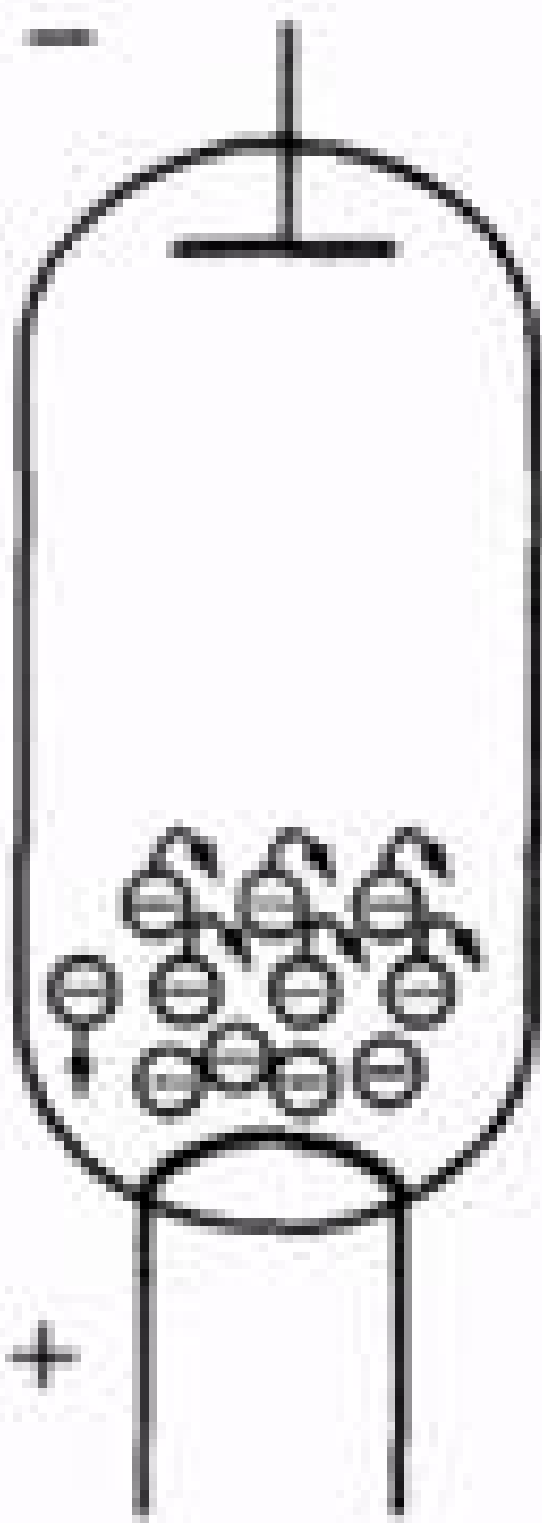
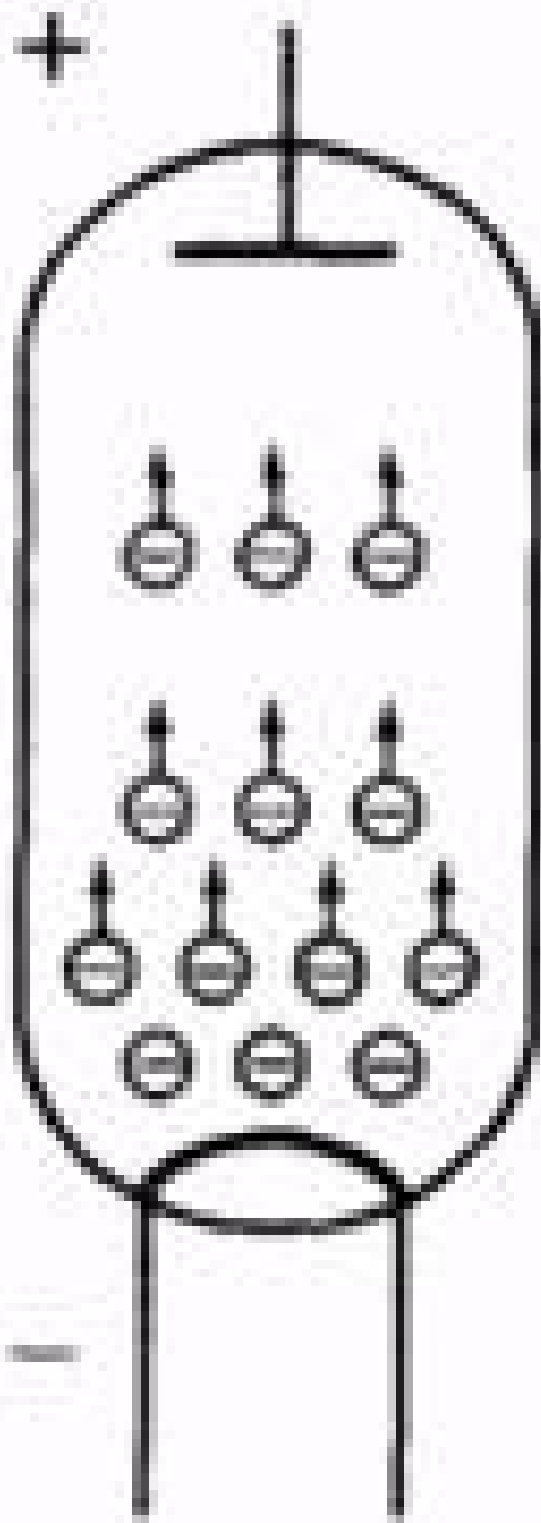

Мал. 2.135

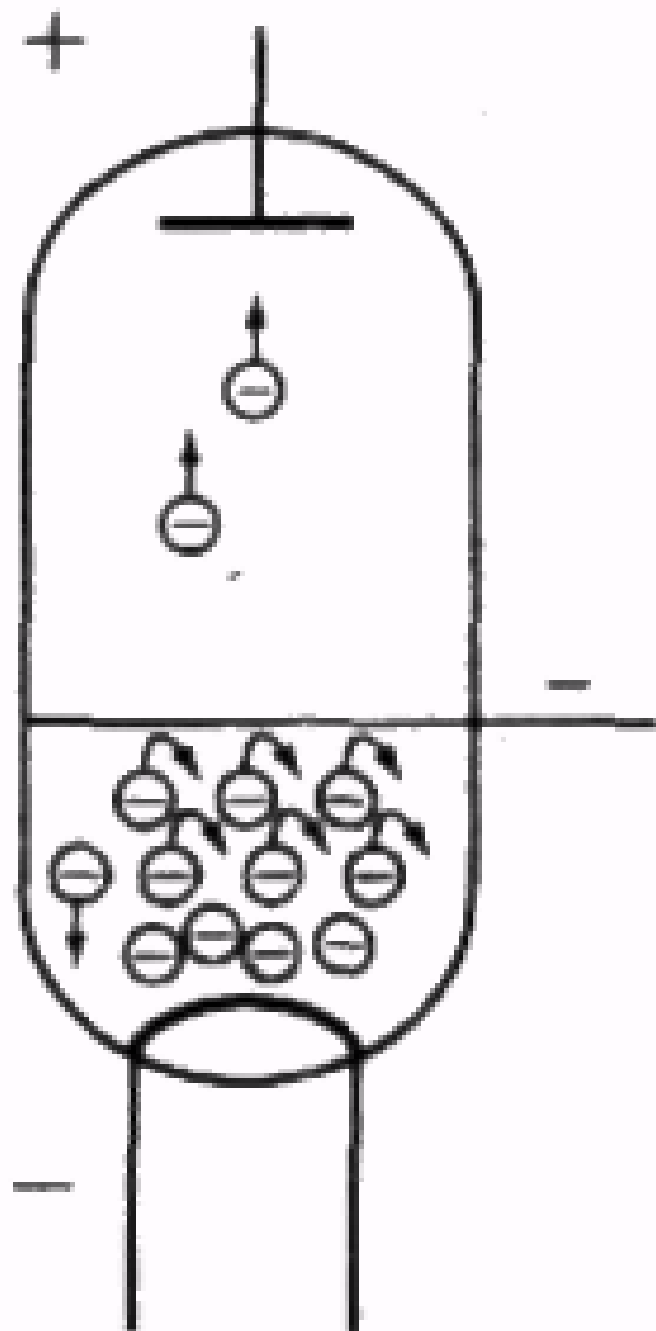
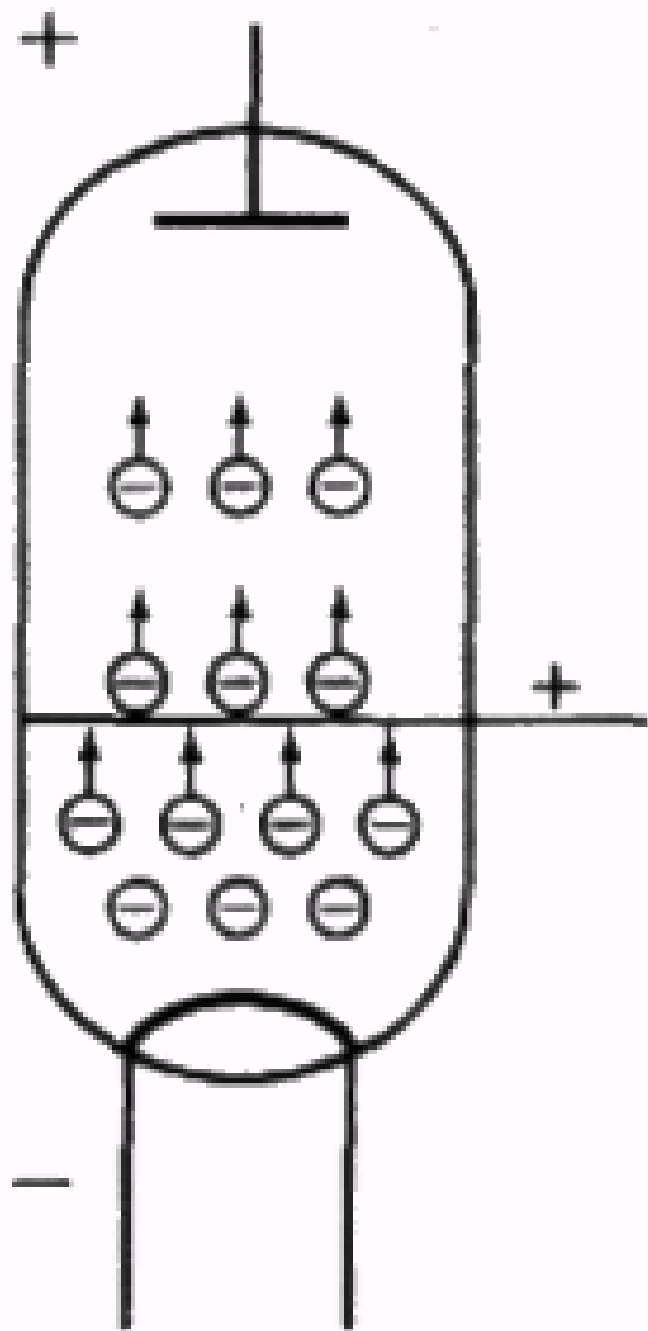

Мал. 2.136

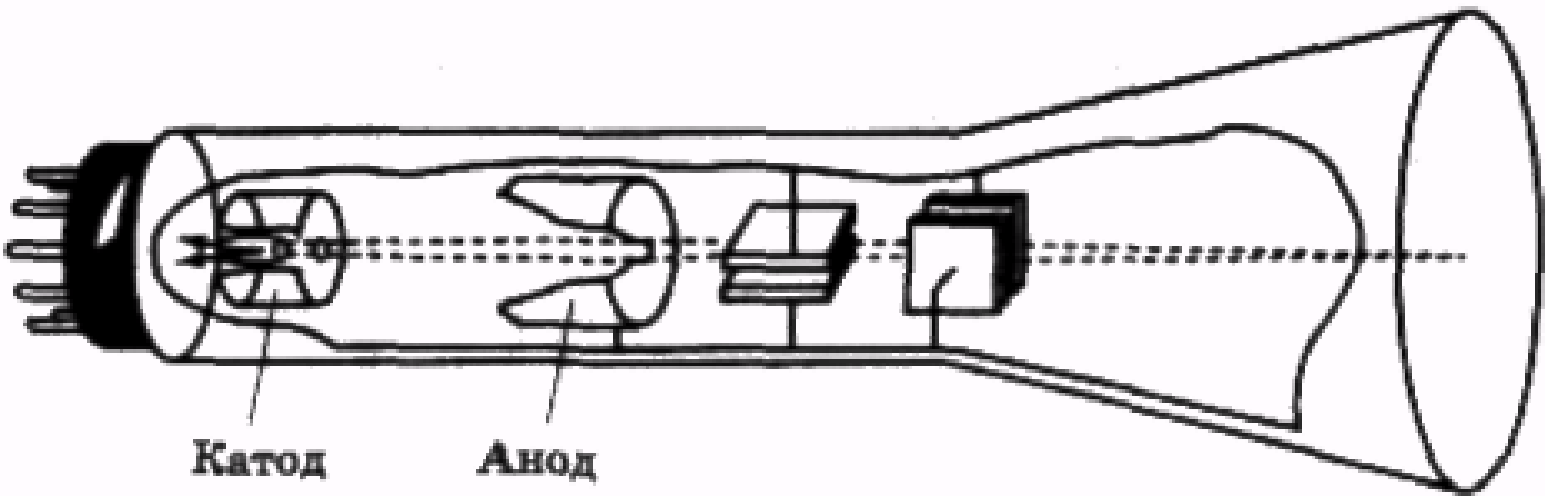

Мал. 2.137

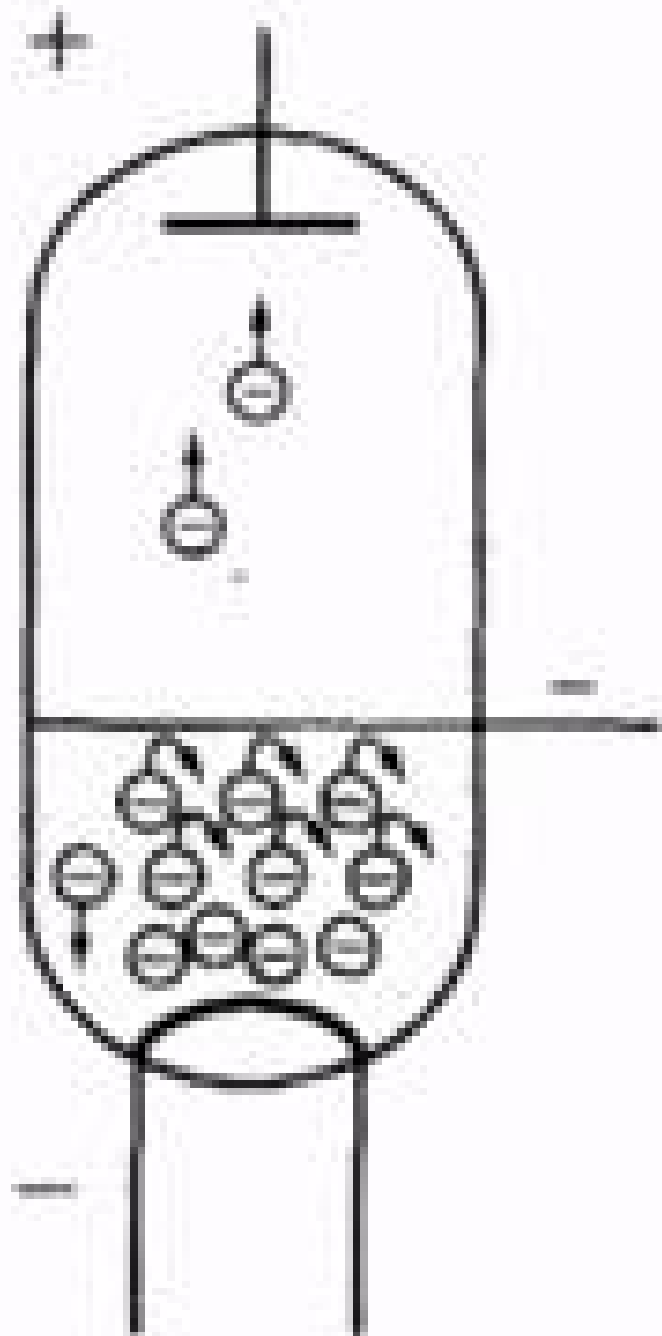
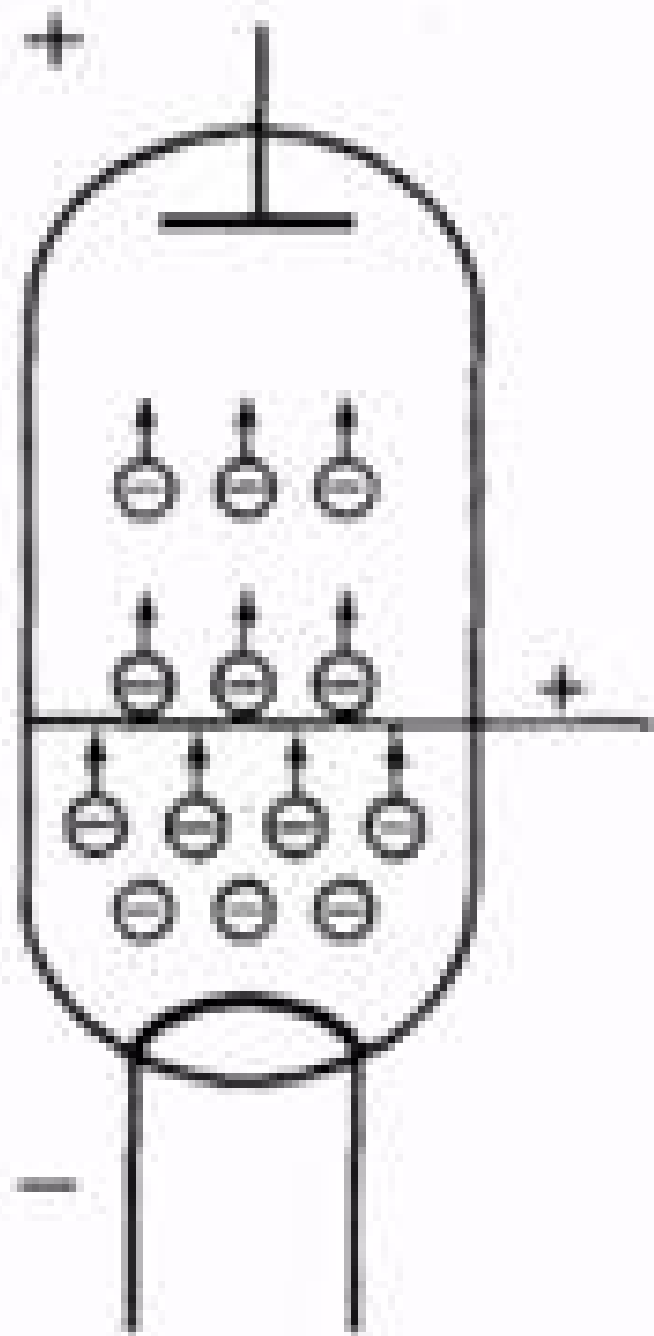

Мал. 2.136

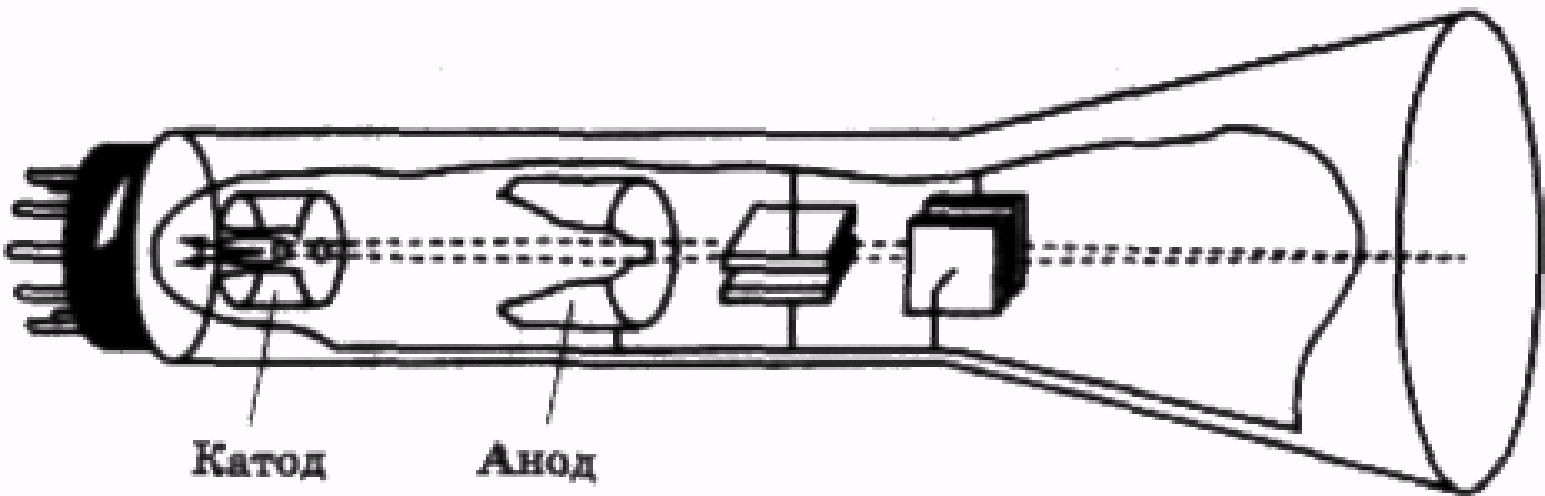

Мал. 2.137

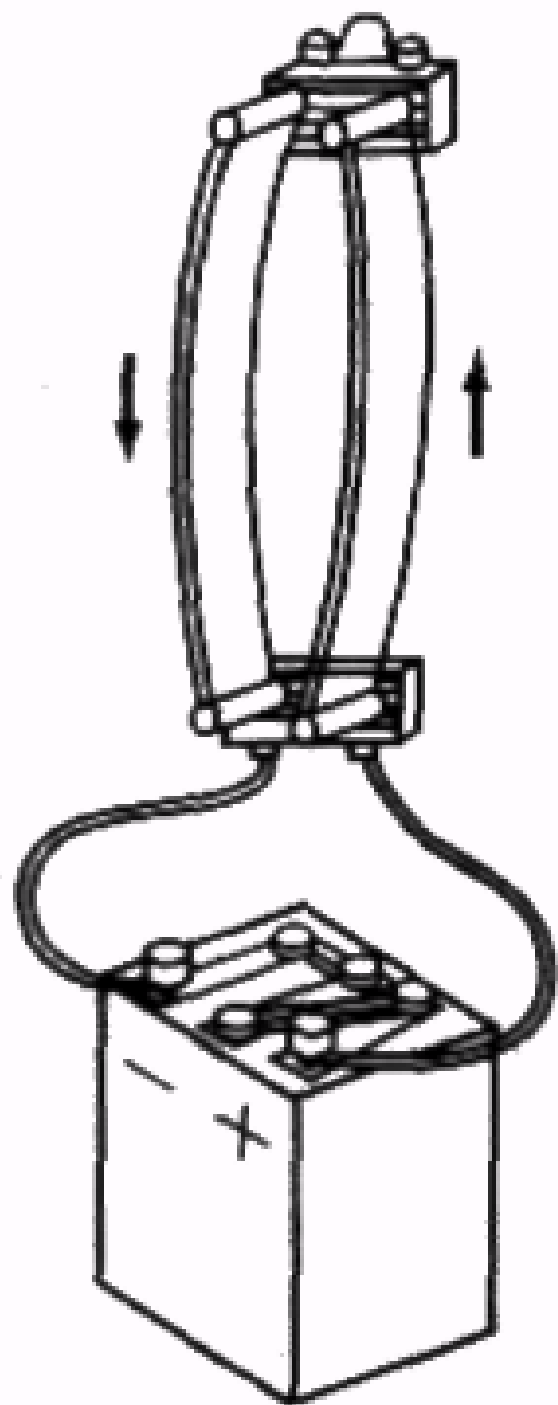
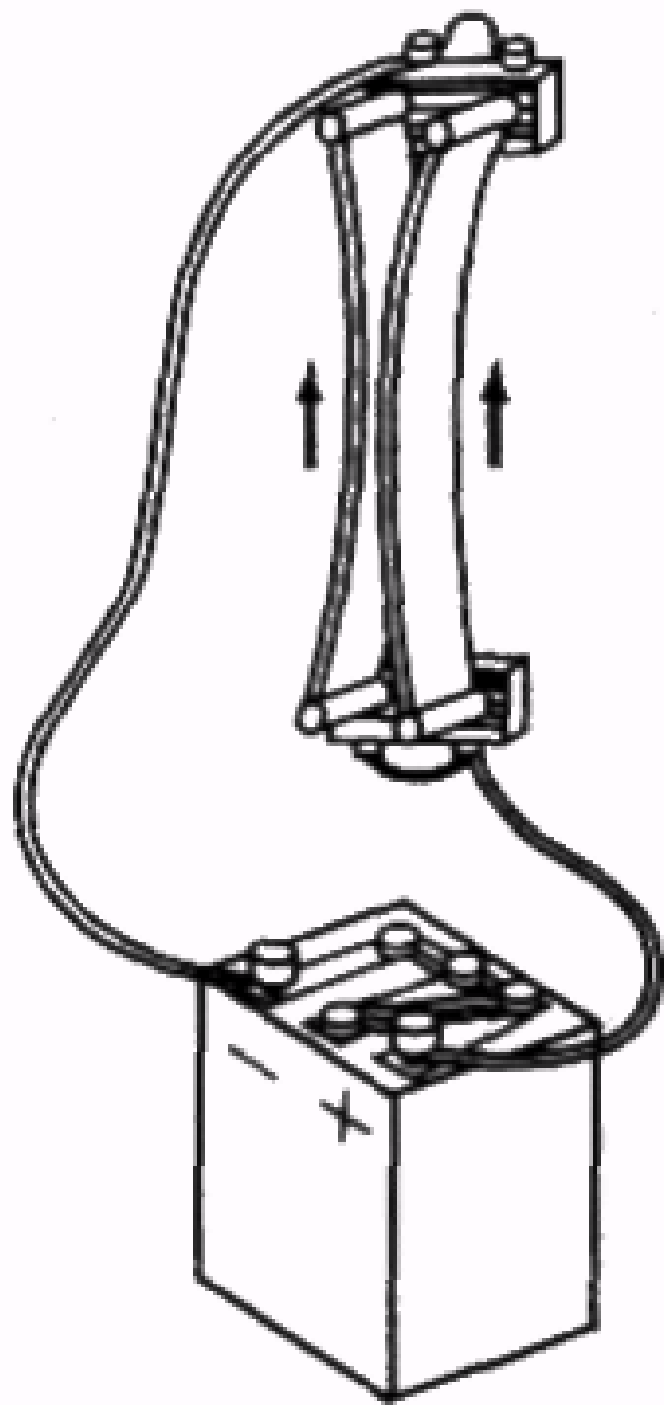

Мал. 2.138

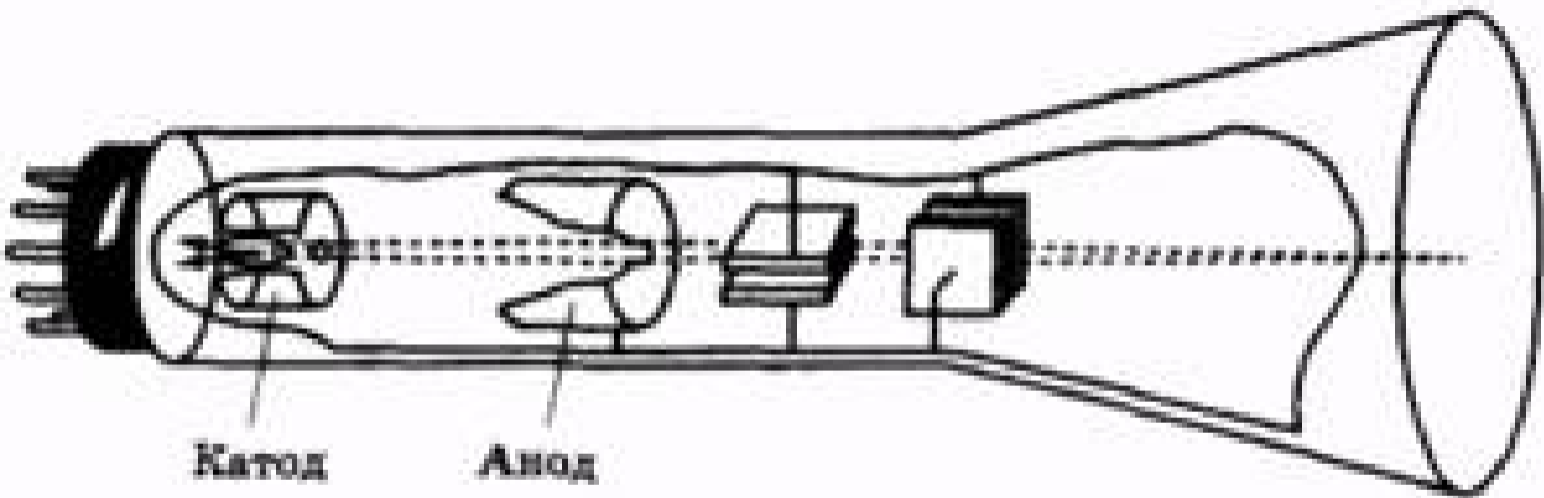

Мал. 2.137

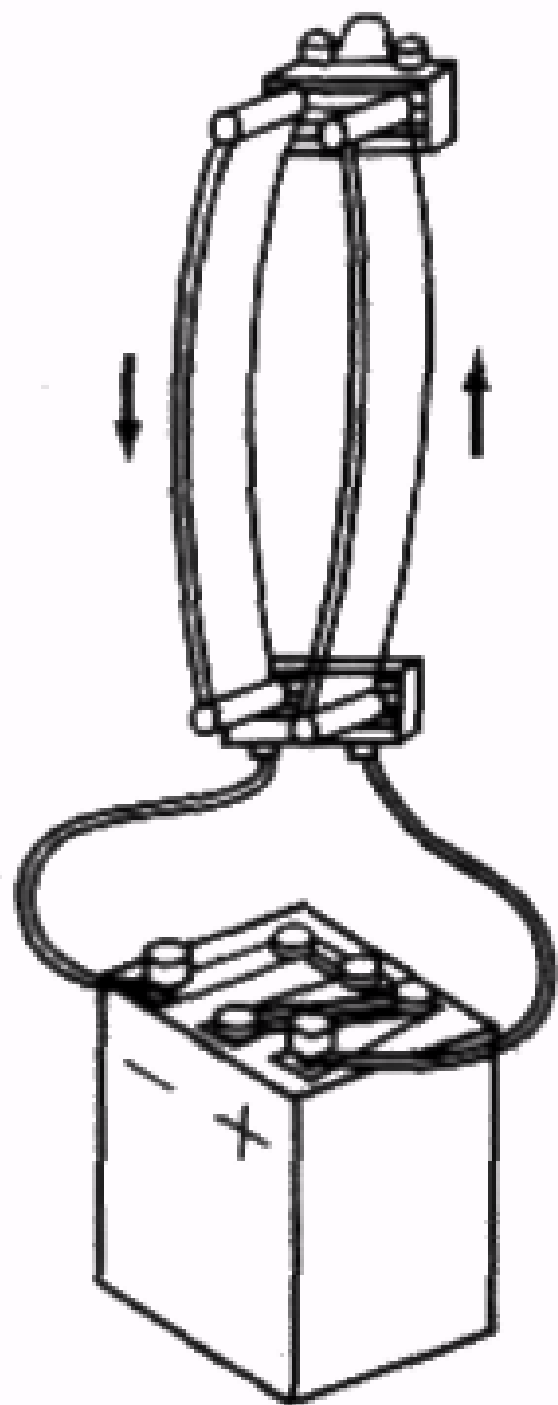
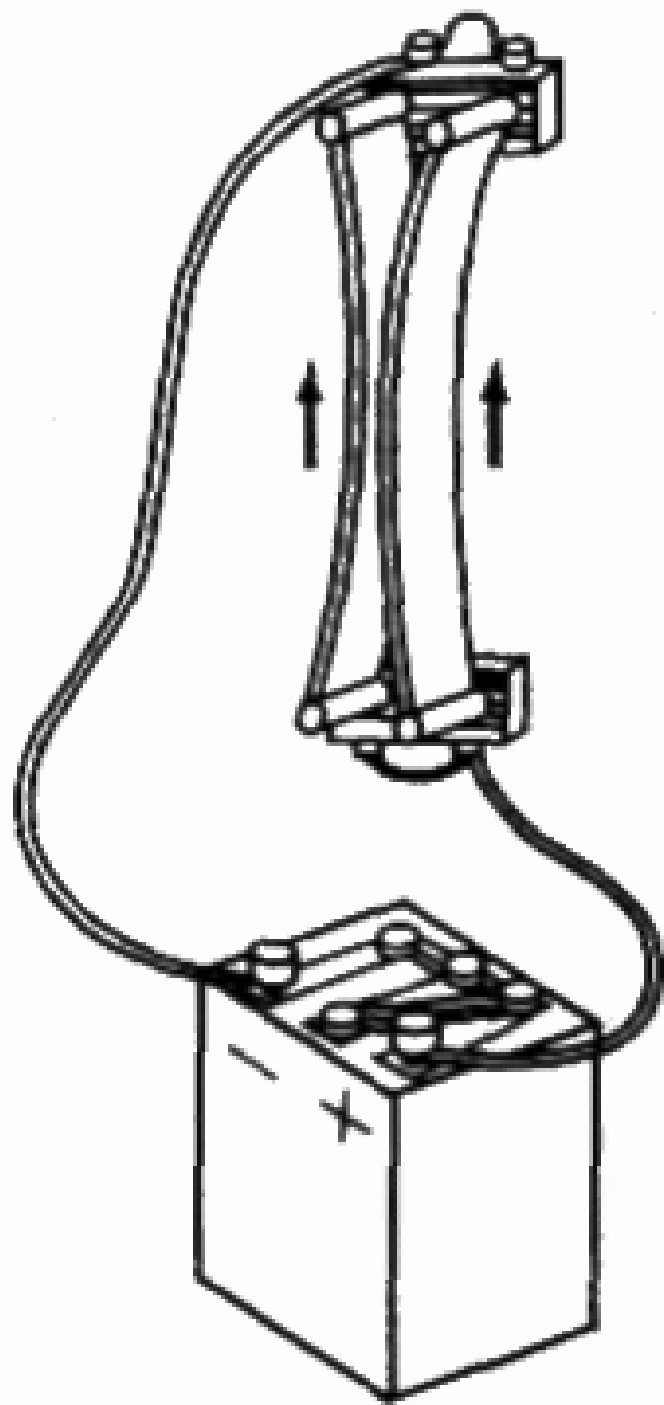

Мал. 2.138

A pixelated, grayscale representation of the number 2. The digits are formed by a grid of black and gray pixels, giving it a blocky, digital appearance.

A pixelated, grayscale representation of the number 3. The digits are formed by a grid of black and gray pixels, giving it a blocky, digital appearance.

A pixelated, grayscale representation of the number 10. The digits are formed by a grid of black and gray pixels, giving it a blocky, digital appearance.

A pixelated, grayscale representation of the number 11. The digits are formed by a grid of black and gray pixels, giving it a blocky, digital appearance.

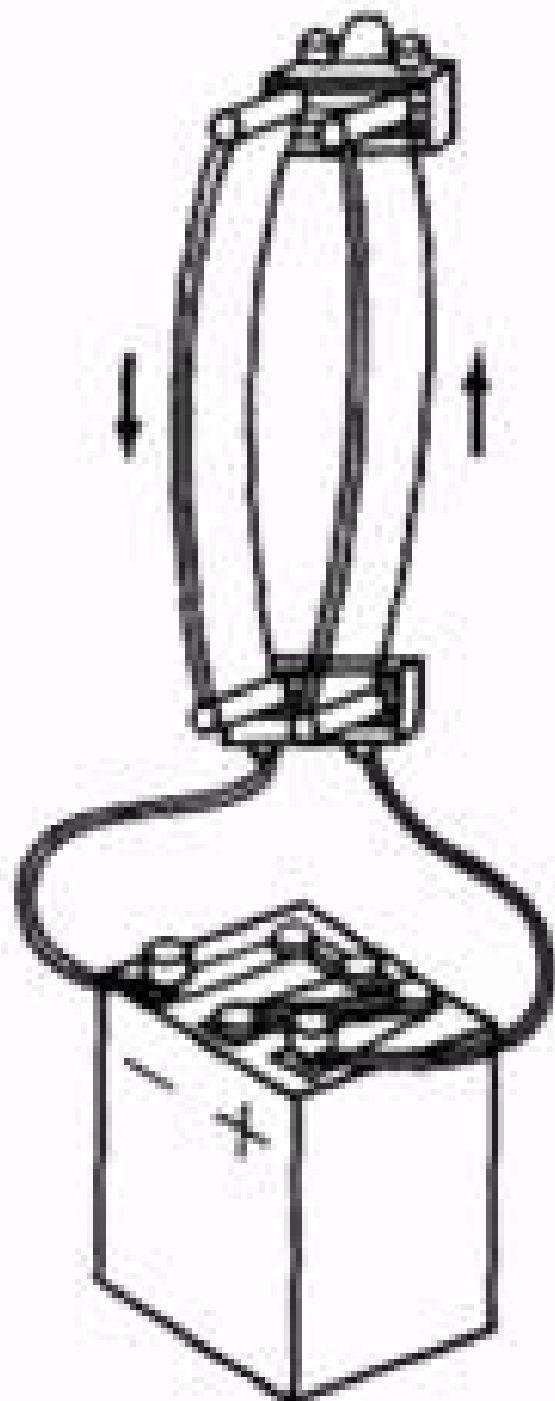
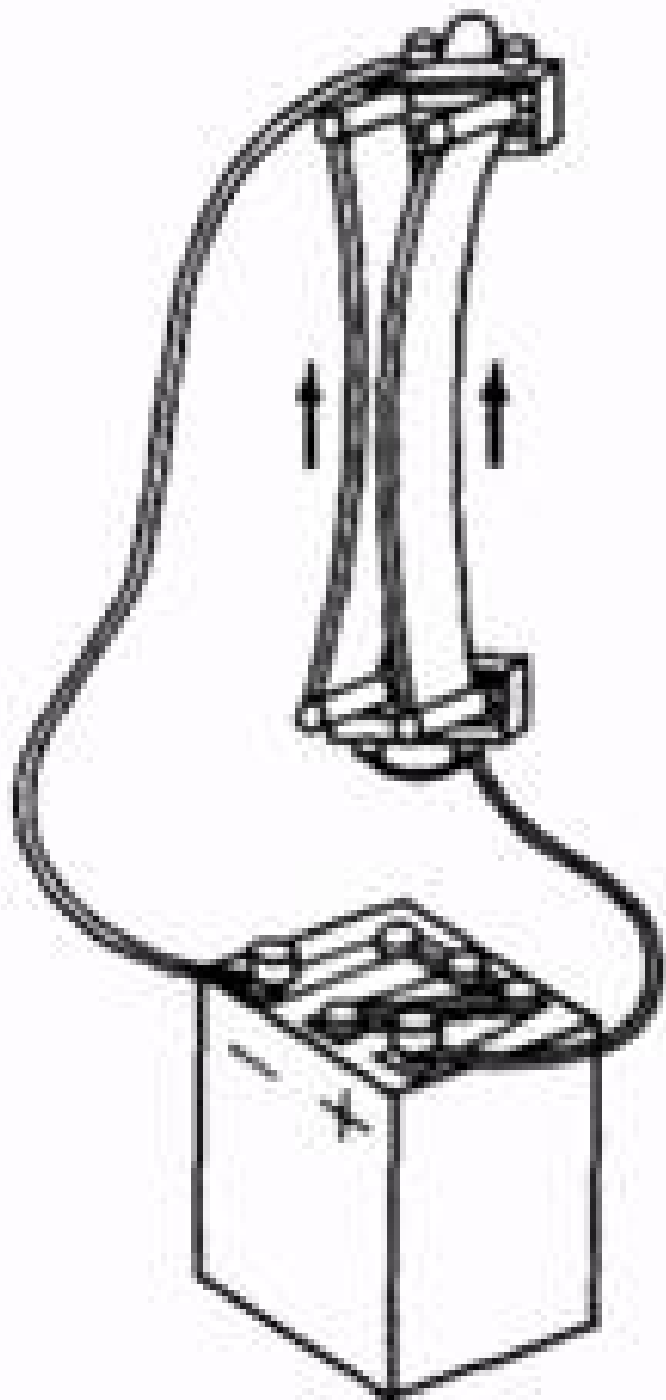

Мал. 2.138

2

.

100%

FI

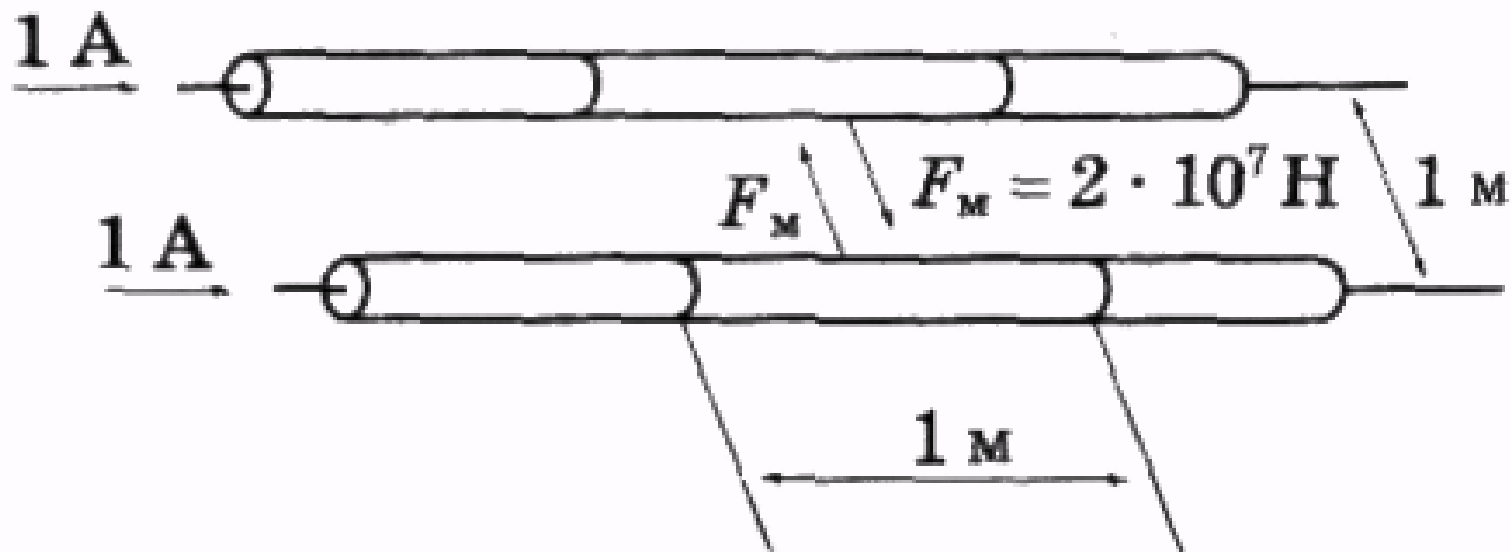

Мал. 2.139

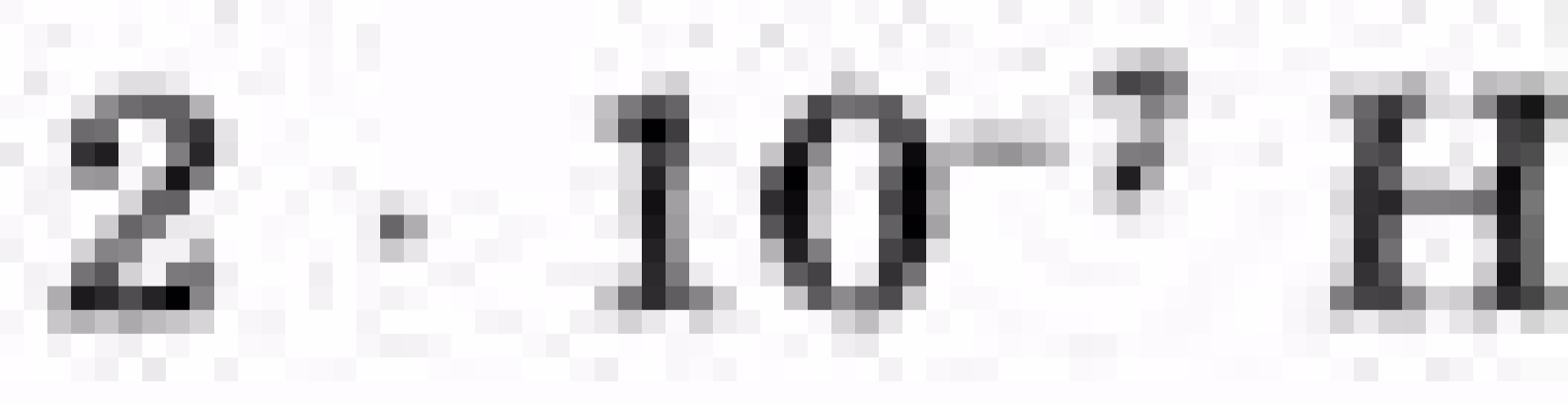

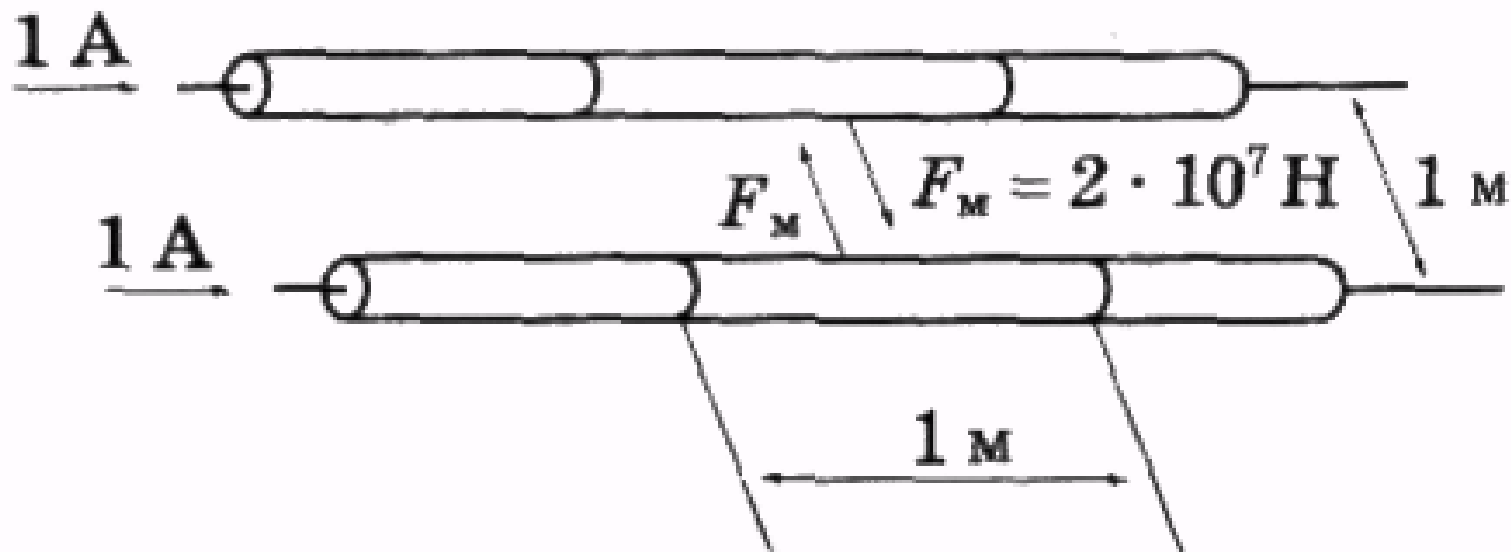

Мал. 2.139

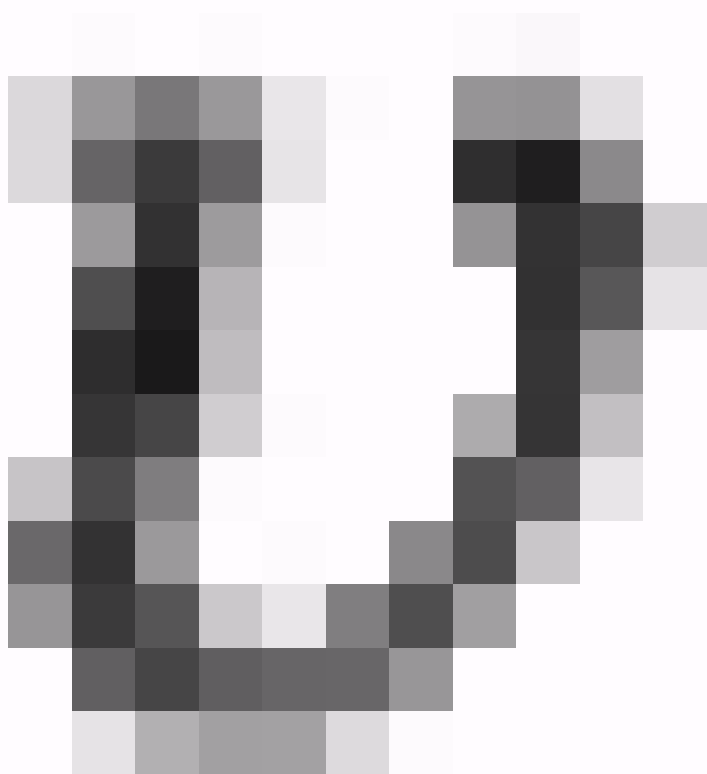
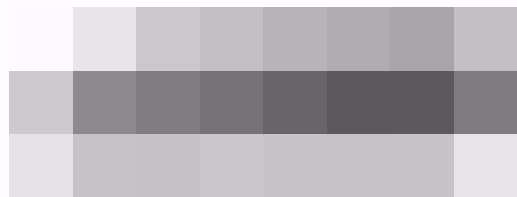

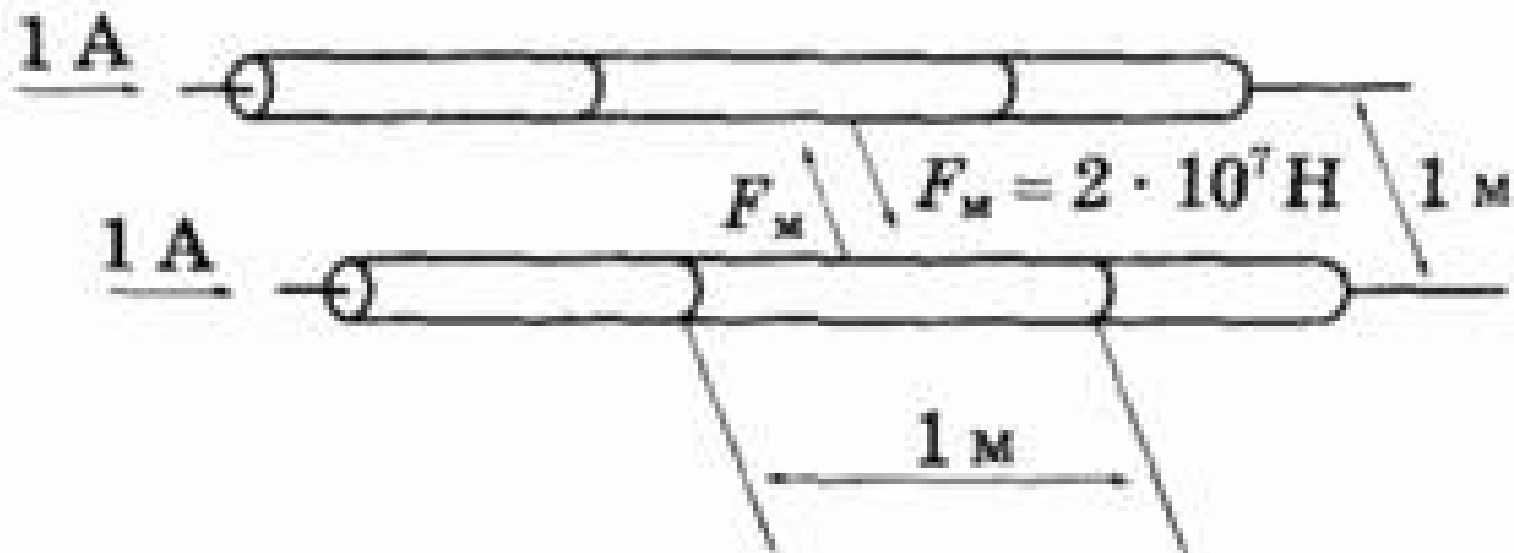

Мал. 2.139

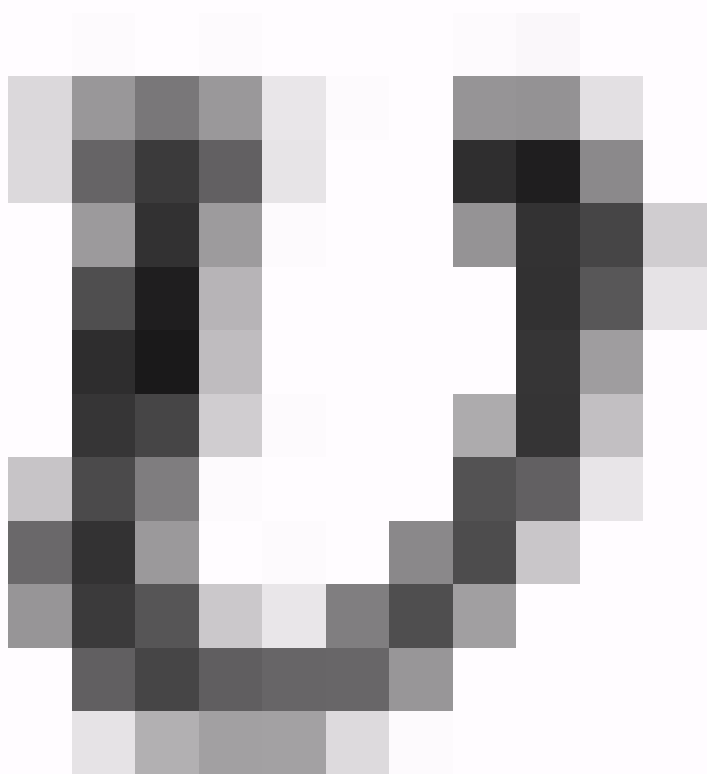
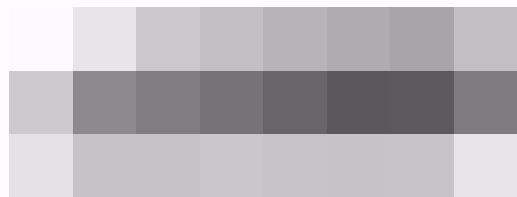

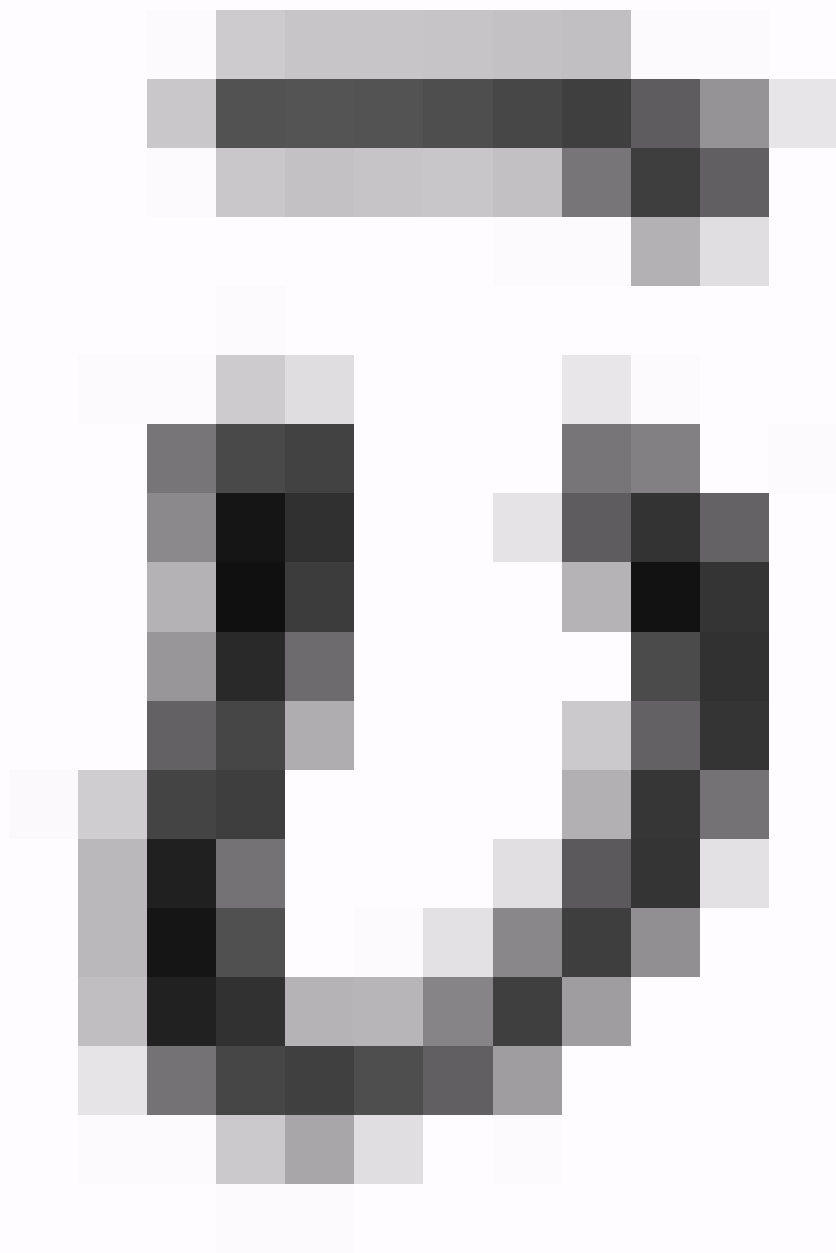

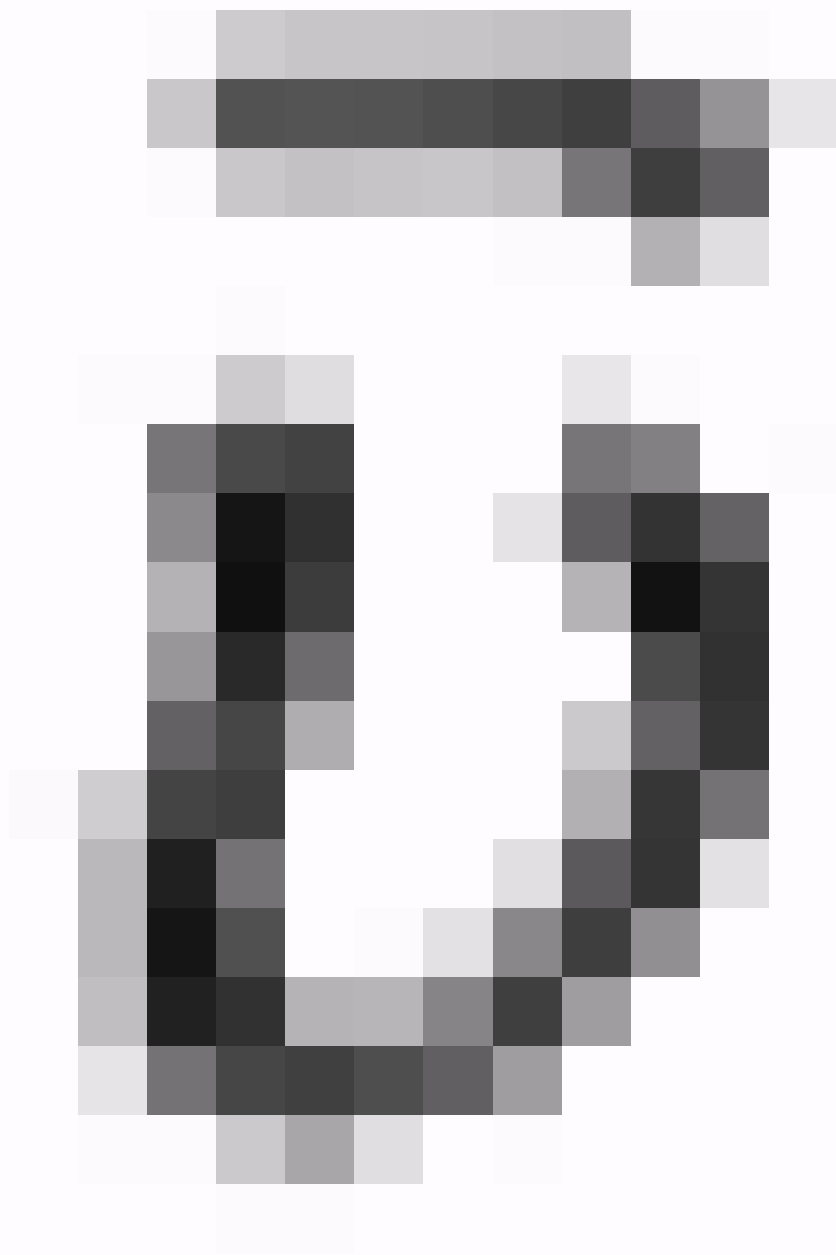

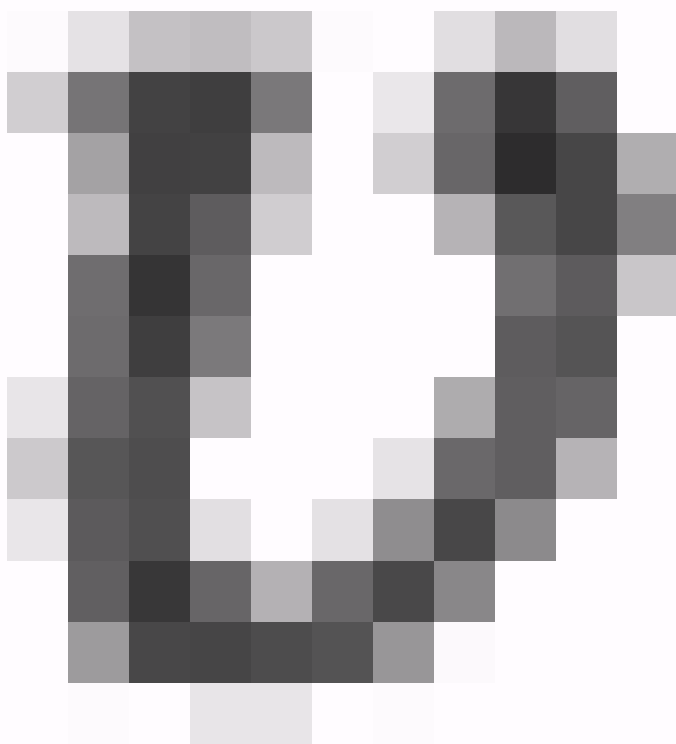
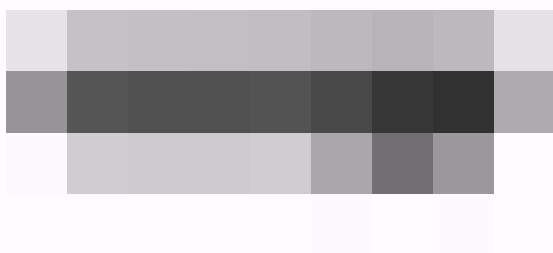

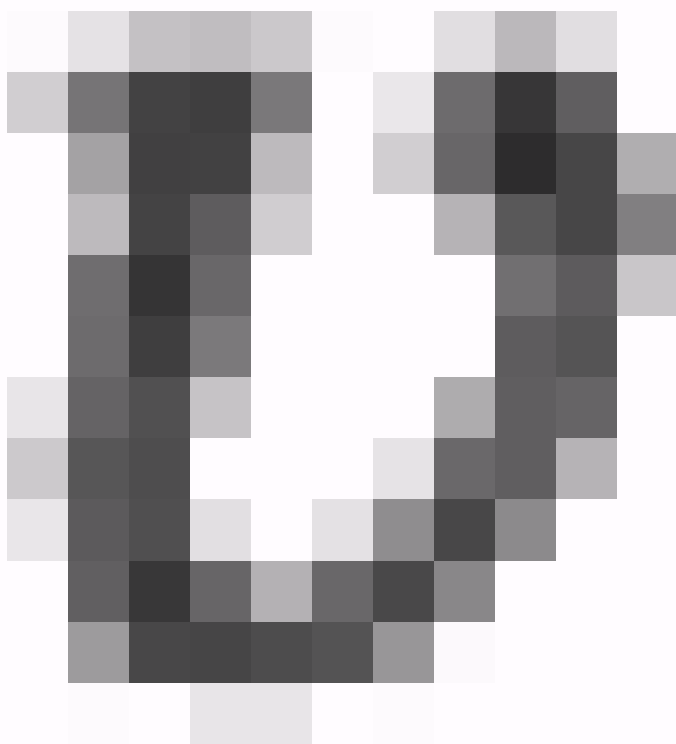
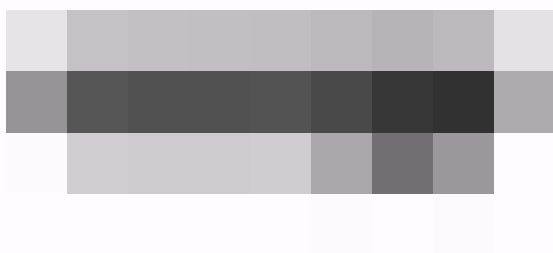

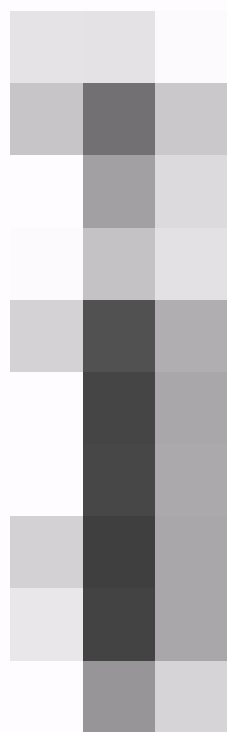
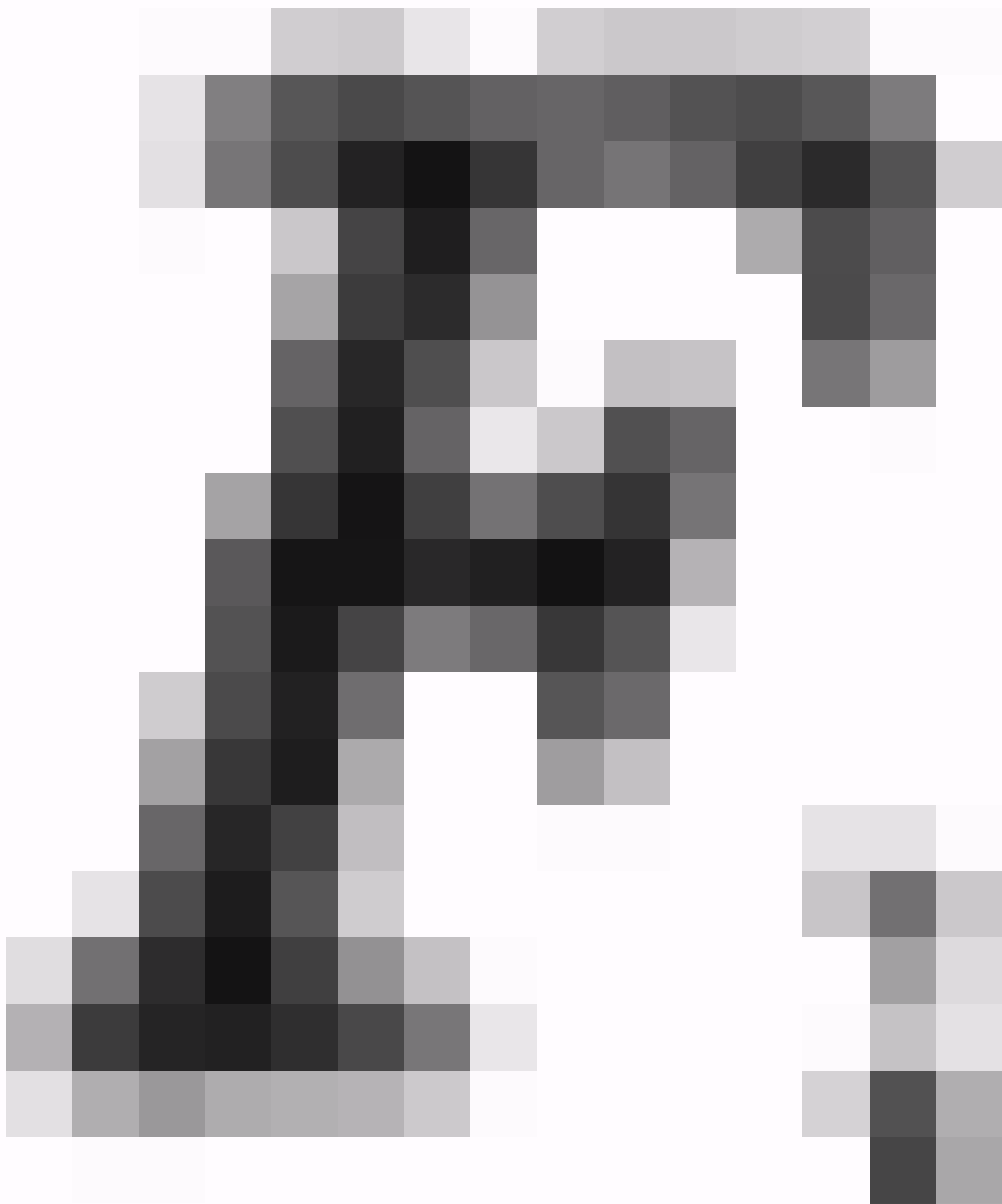
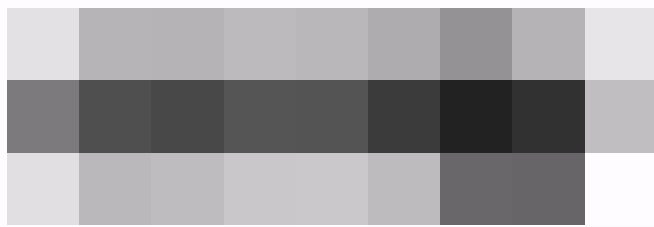

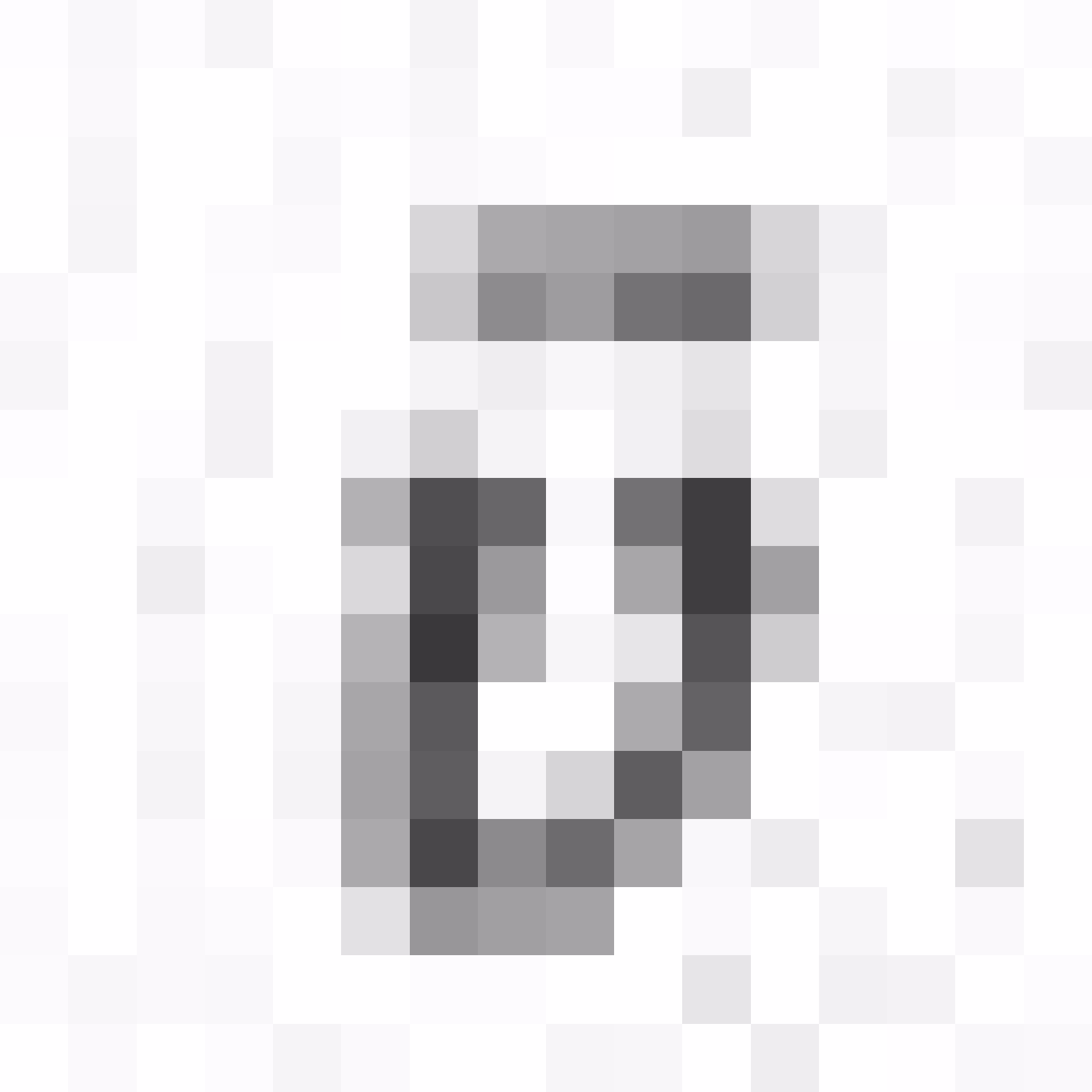

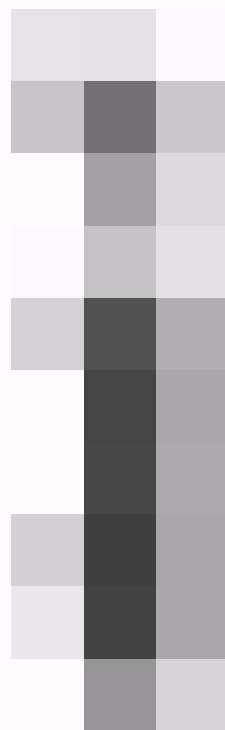
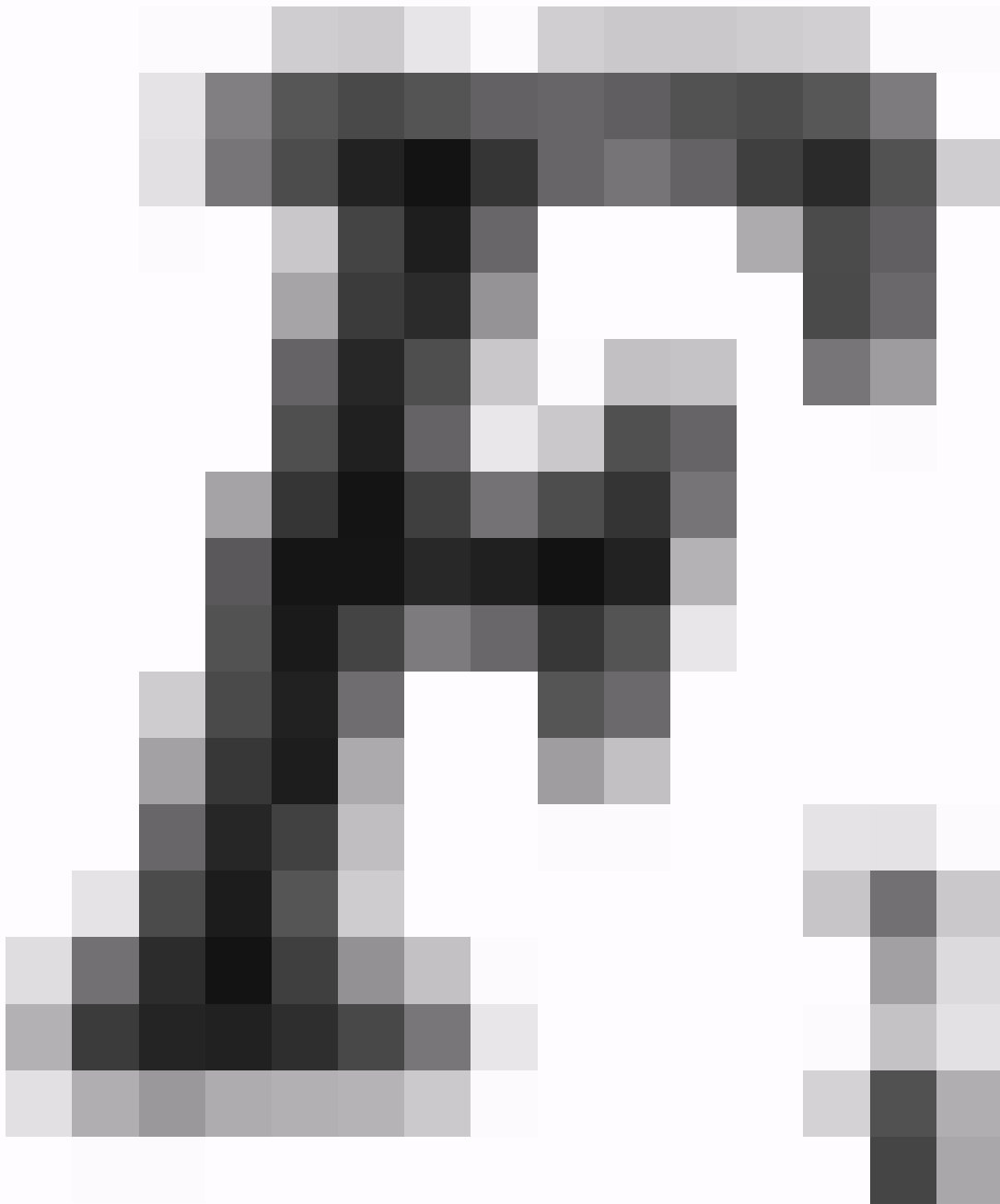
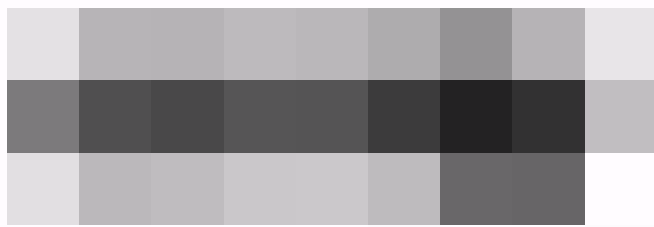

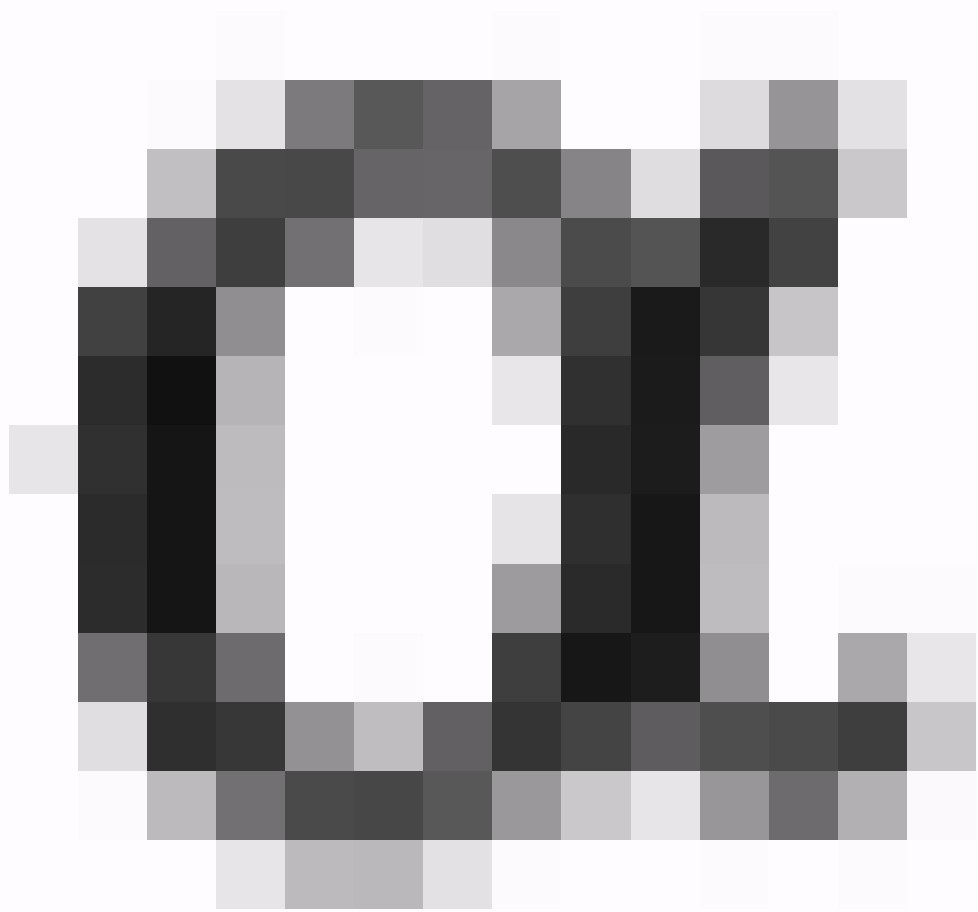

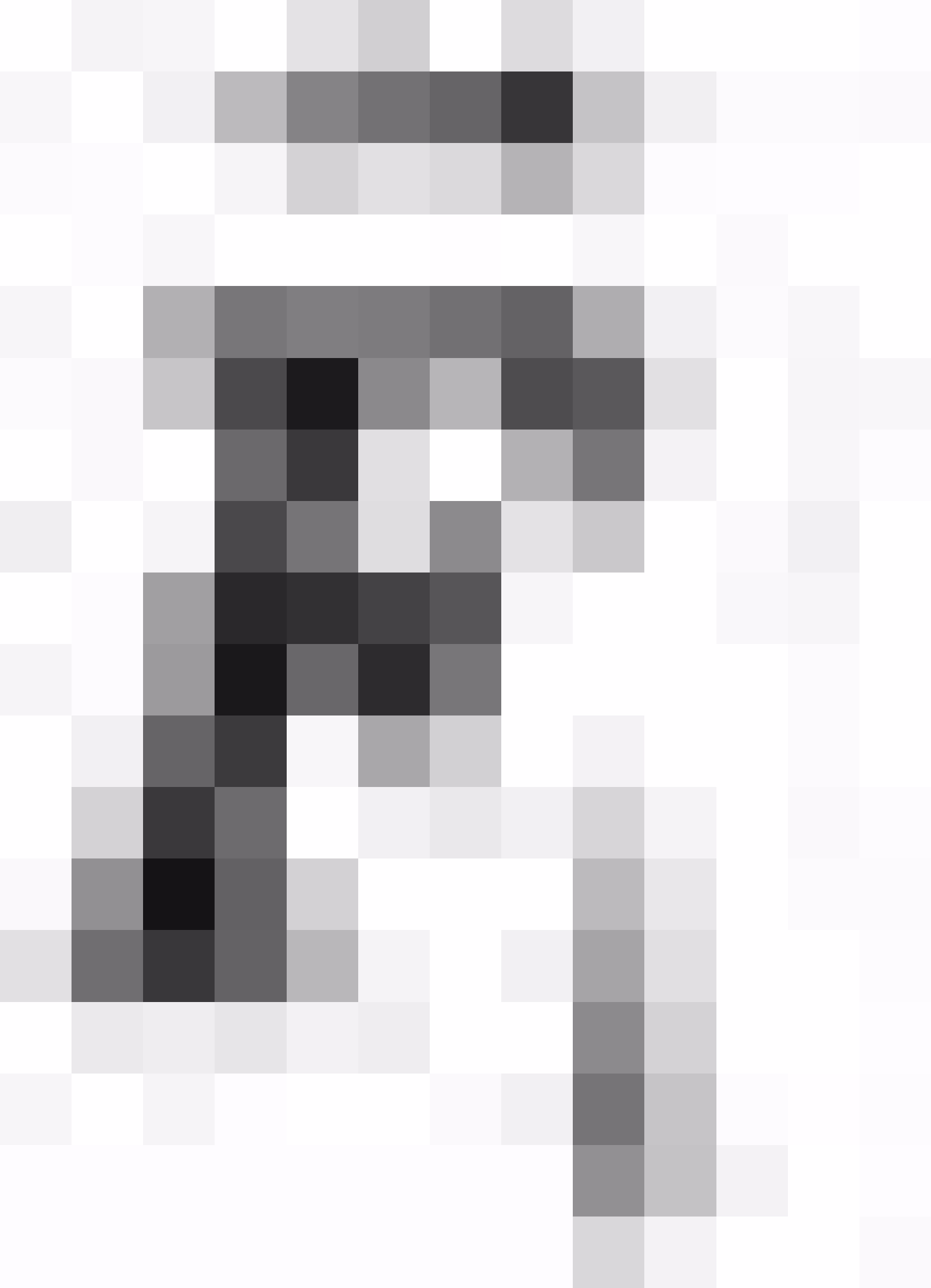

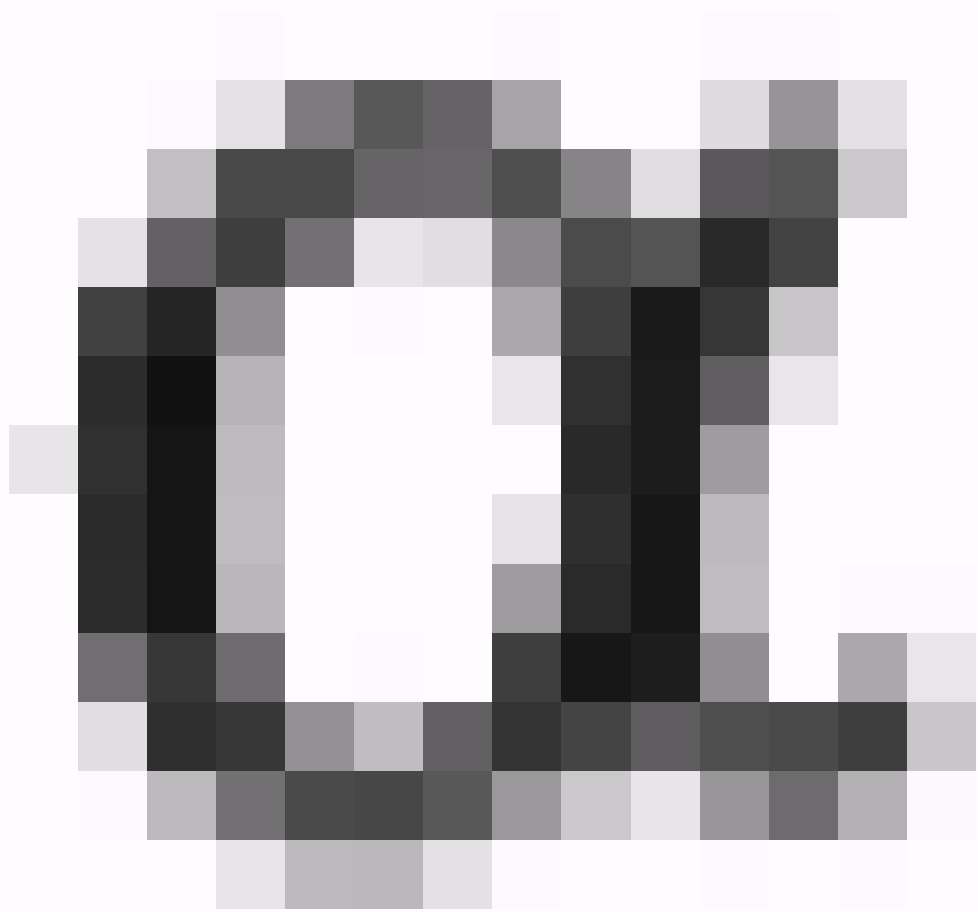

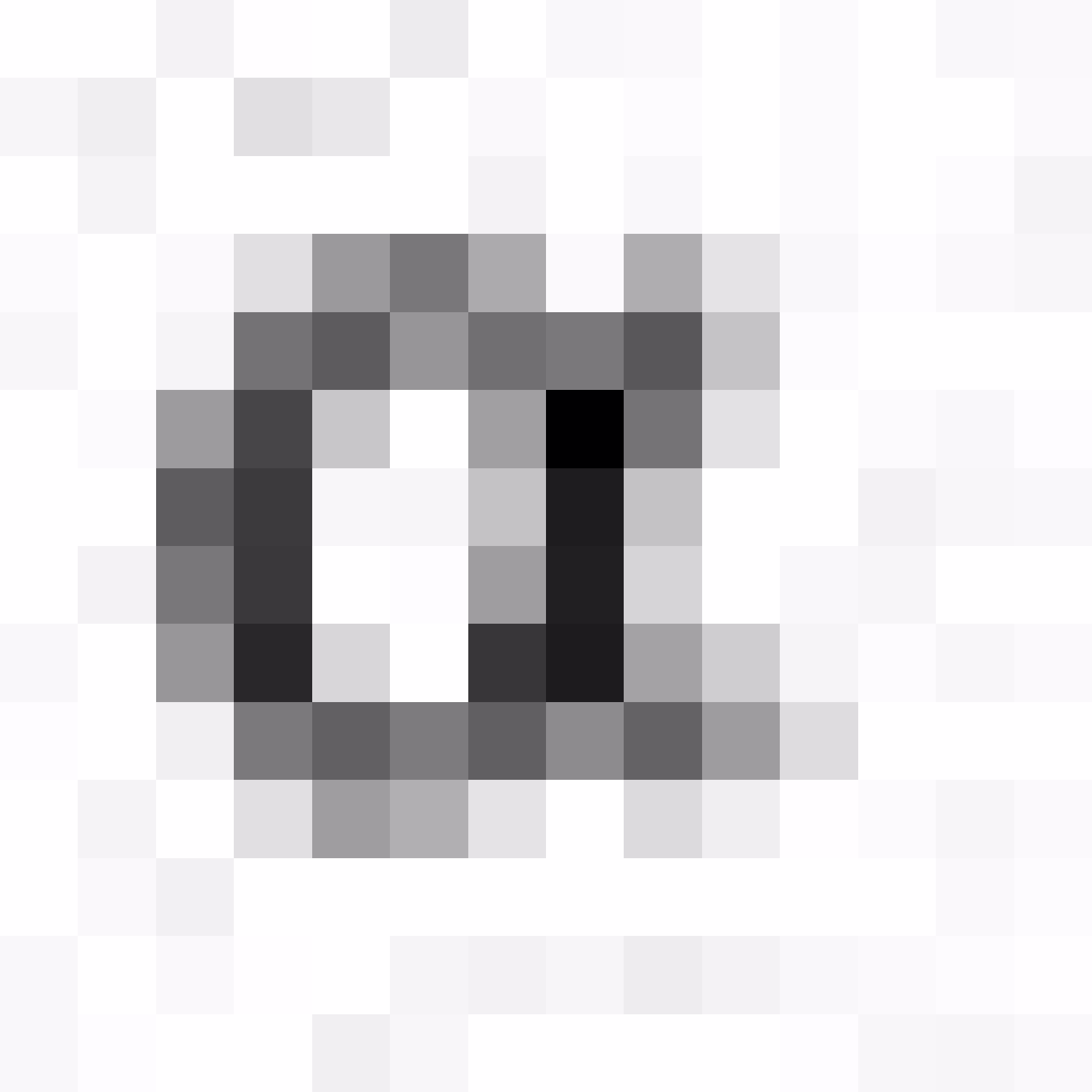

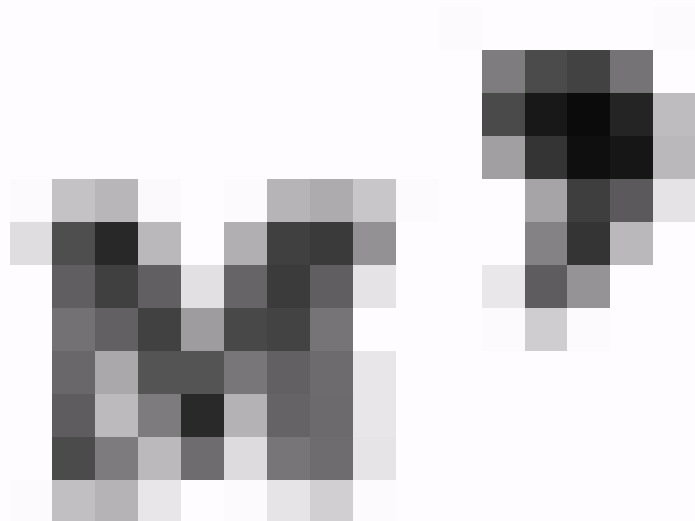
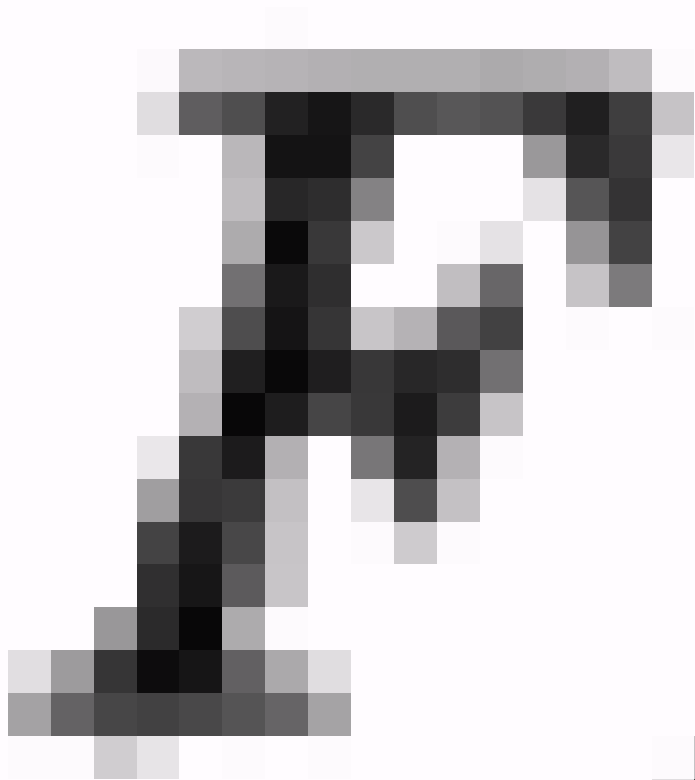



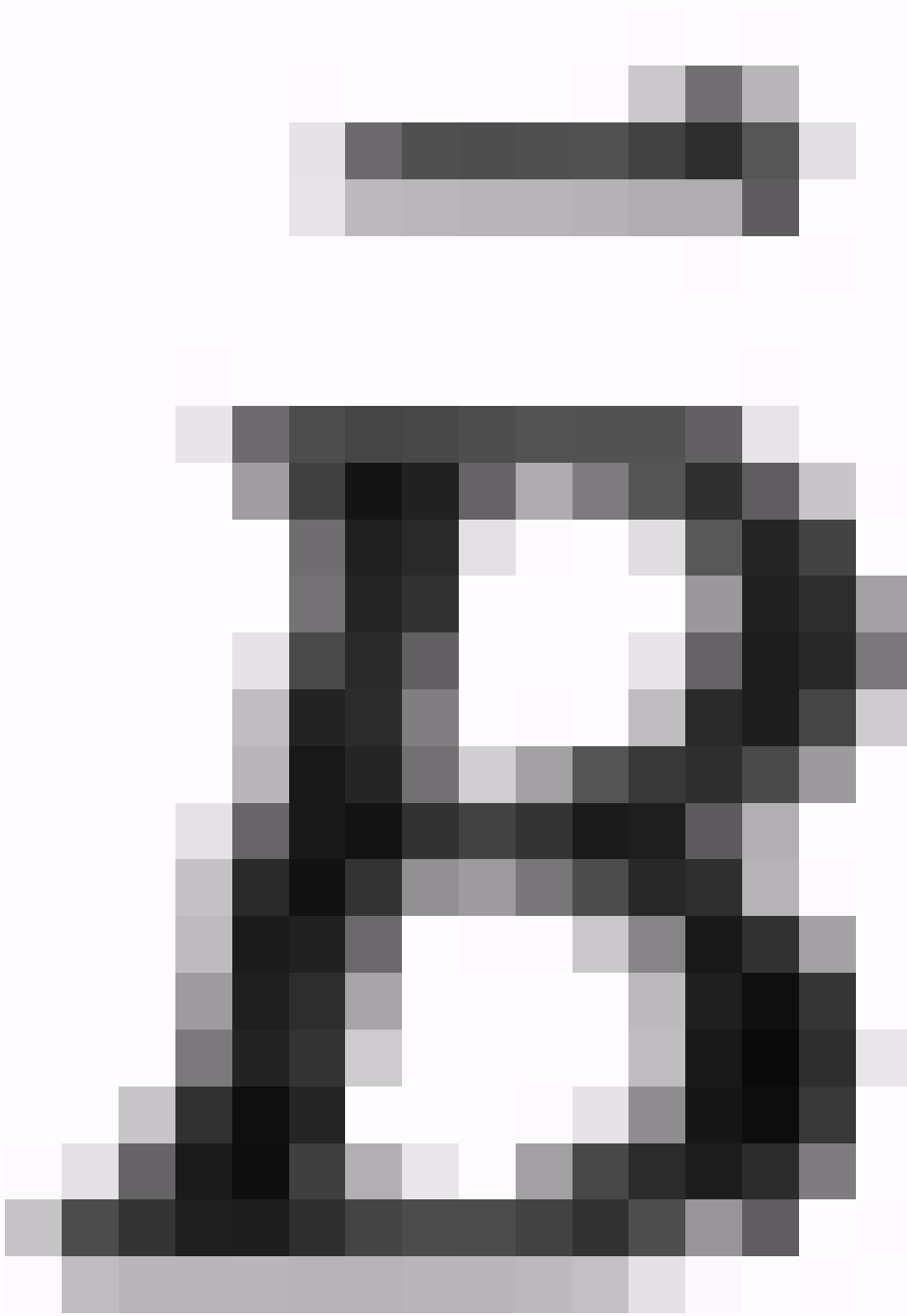



$$B = \frac{F_N}{qv \sin \alpha}$$



$$B = \frac{F_N}{qv \sin \alpha}$$

$$I_{\Gamma\Delta} = \frac{IH}{IK_{\Delta} \cdot I_{M/C}}.$$

19

20

21

22

23

$$I_{\Gamma\Delta} = \frac{IH}{IK_{\Delta} \cdot I_{M/C}}.$$

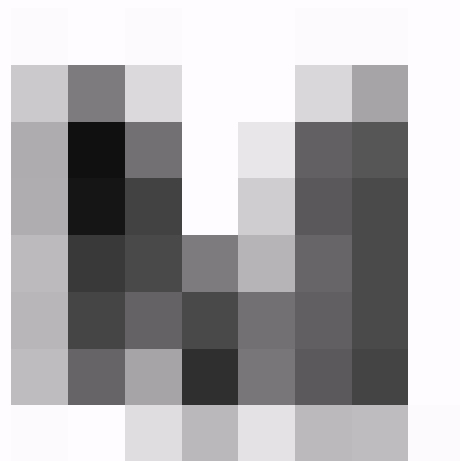
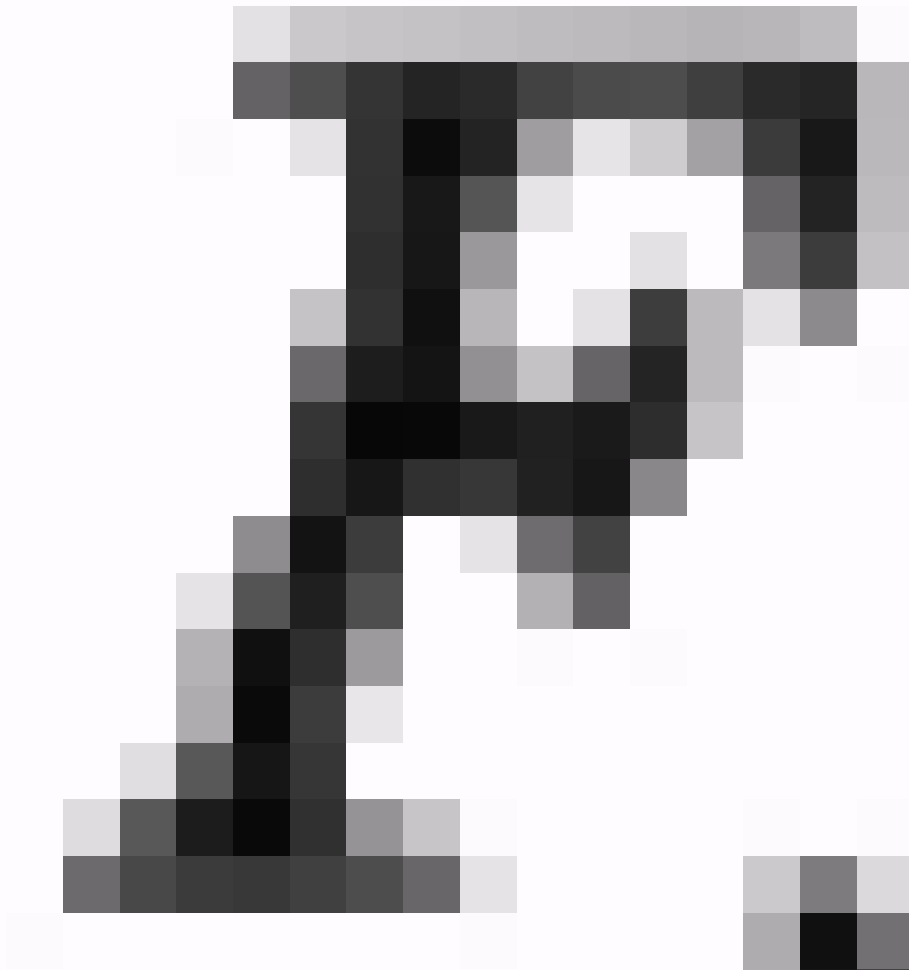
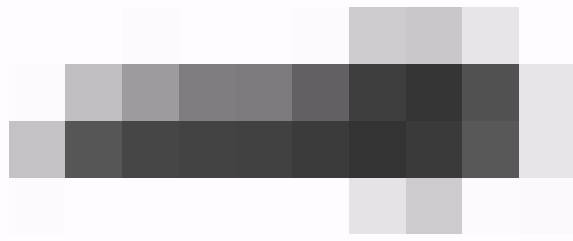

ITM =

IRI

IRI - IRI

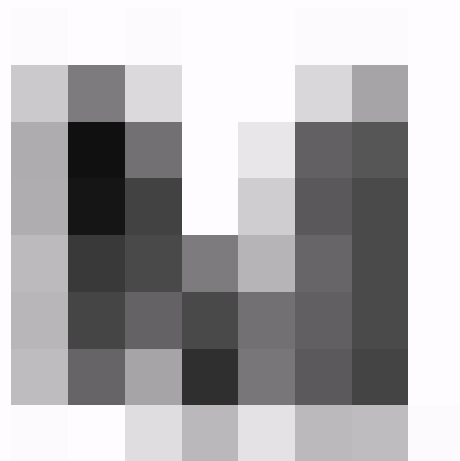
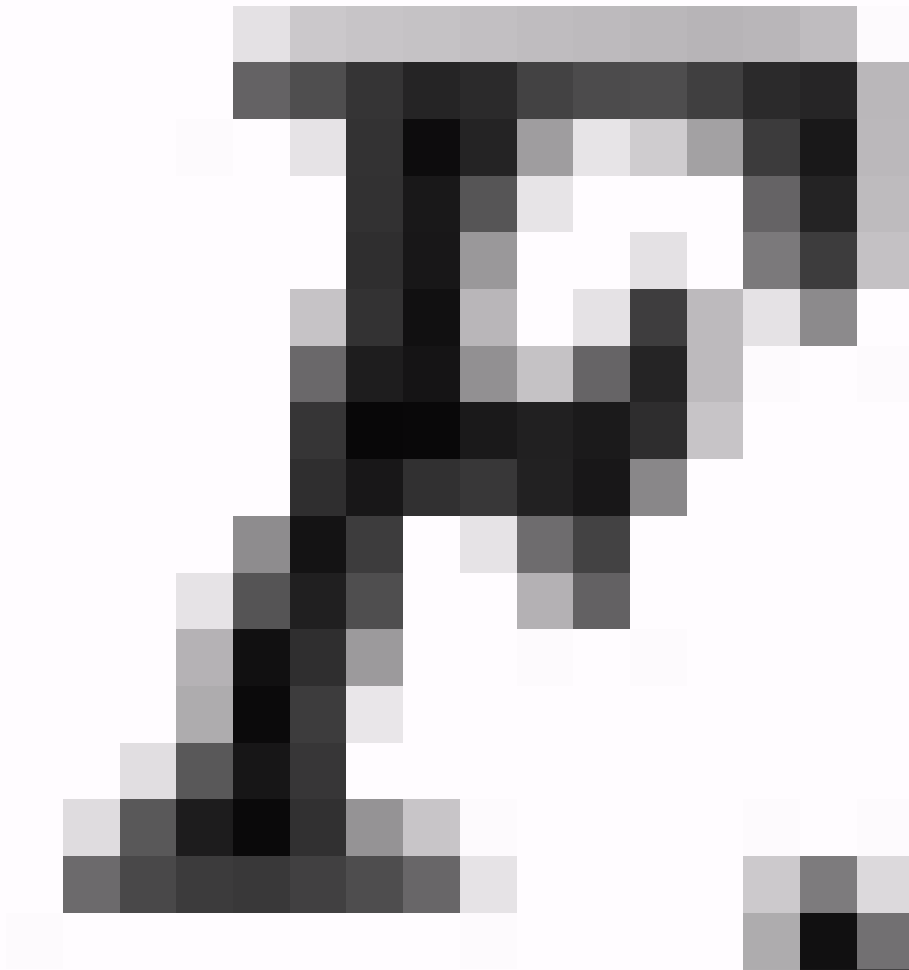
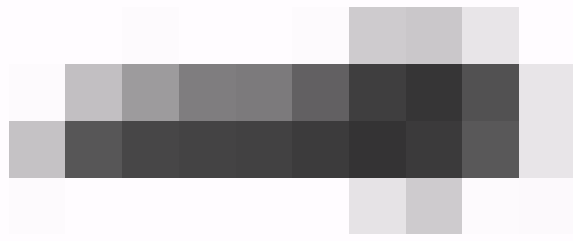

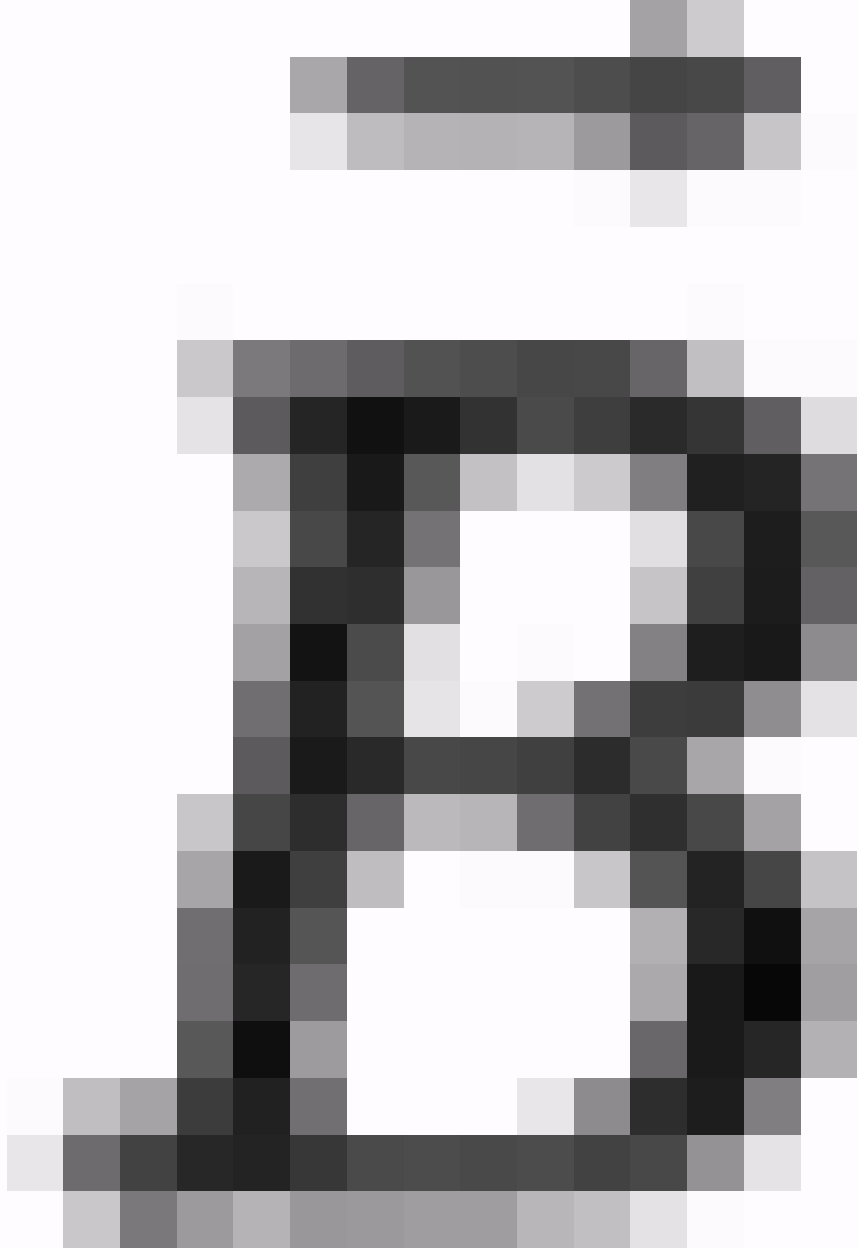



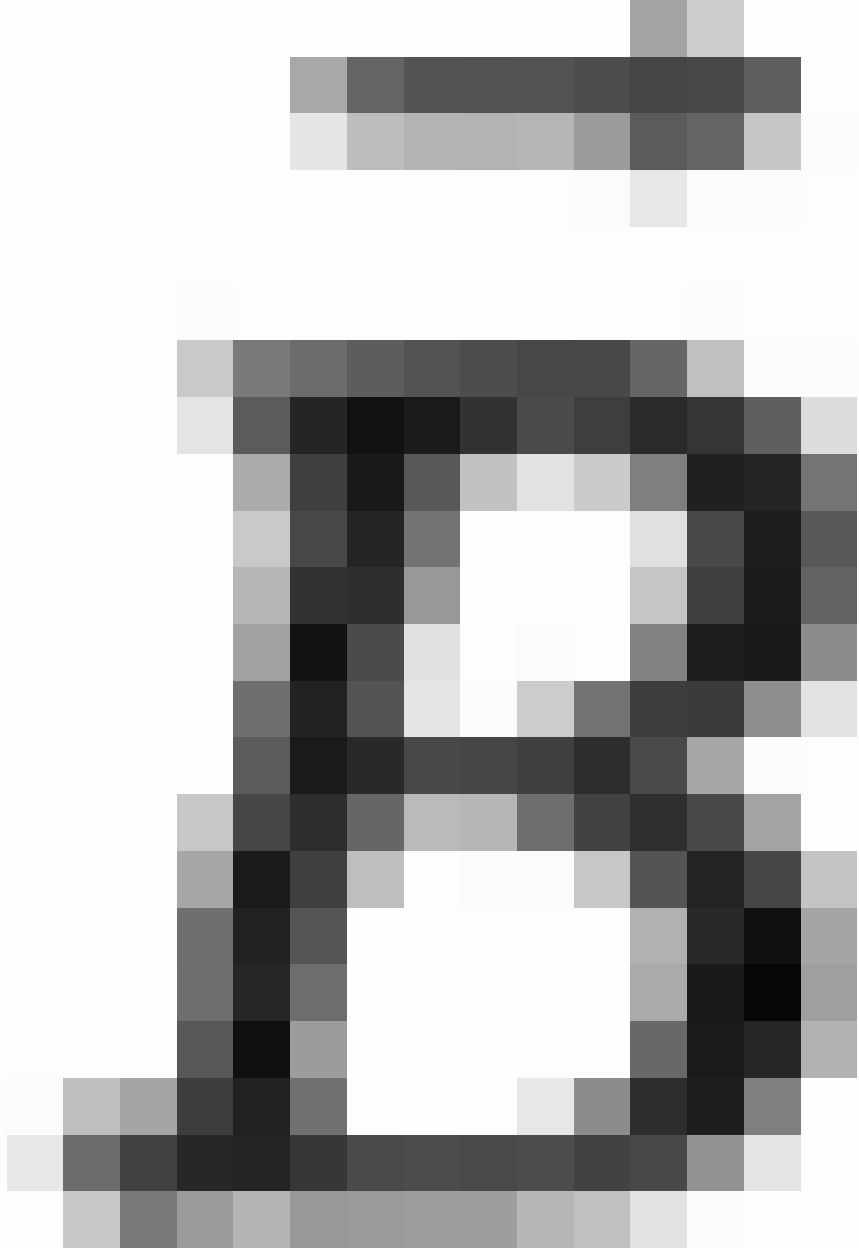

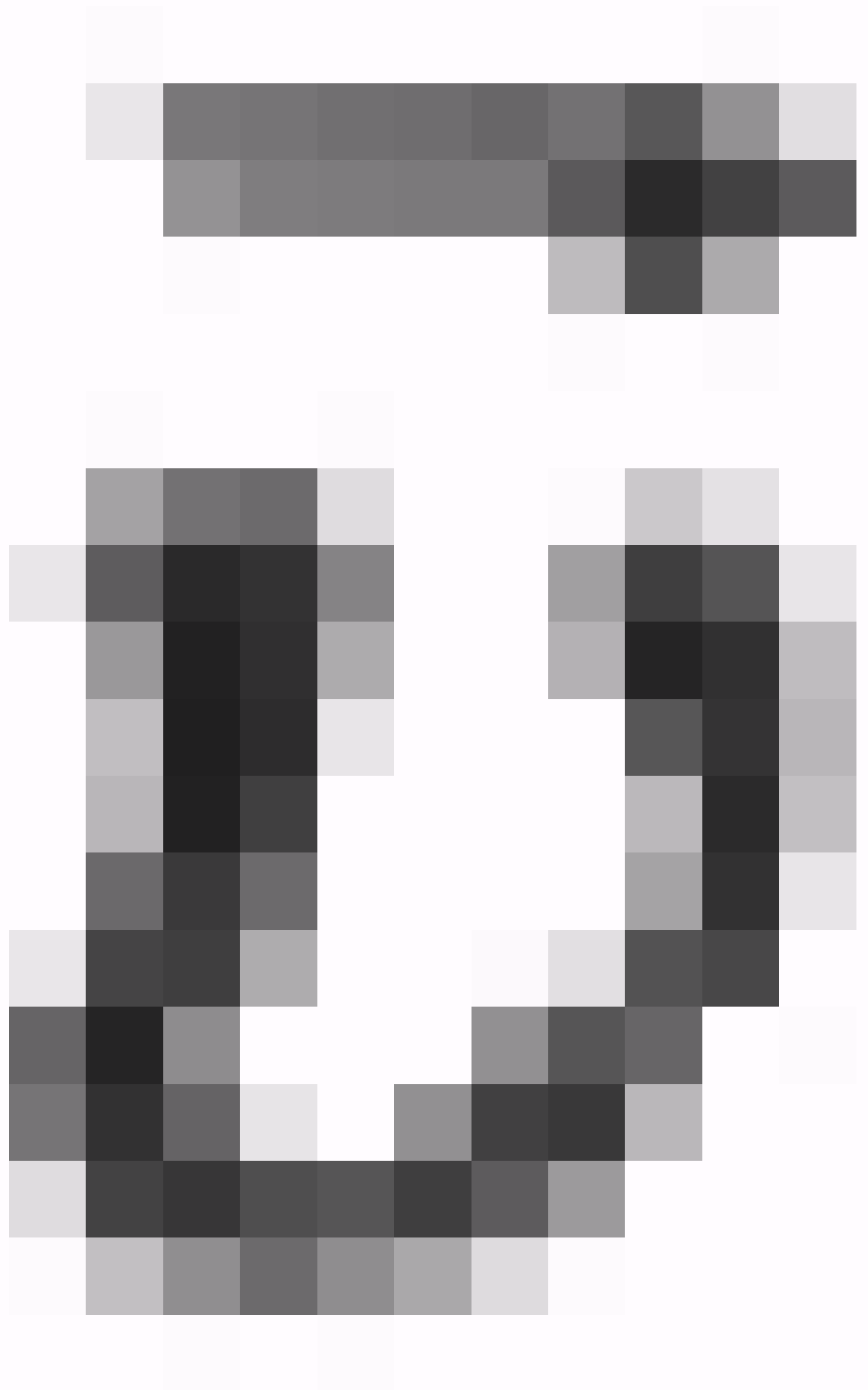

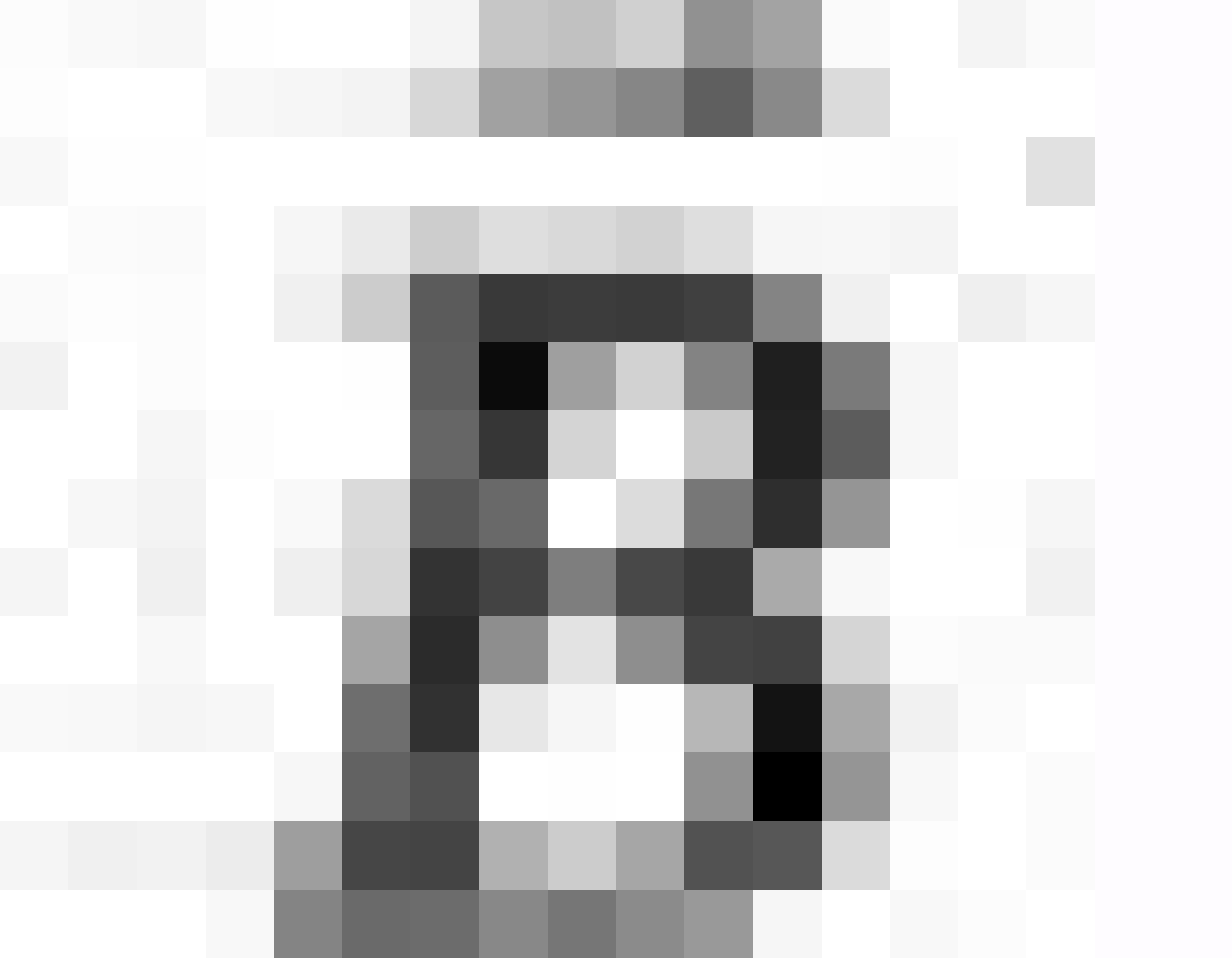

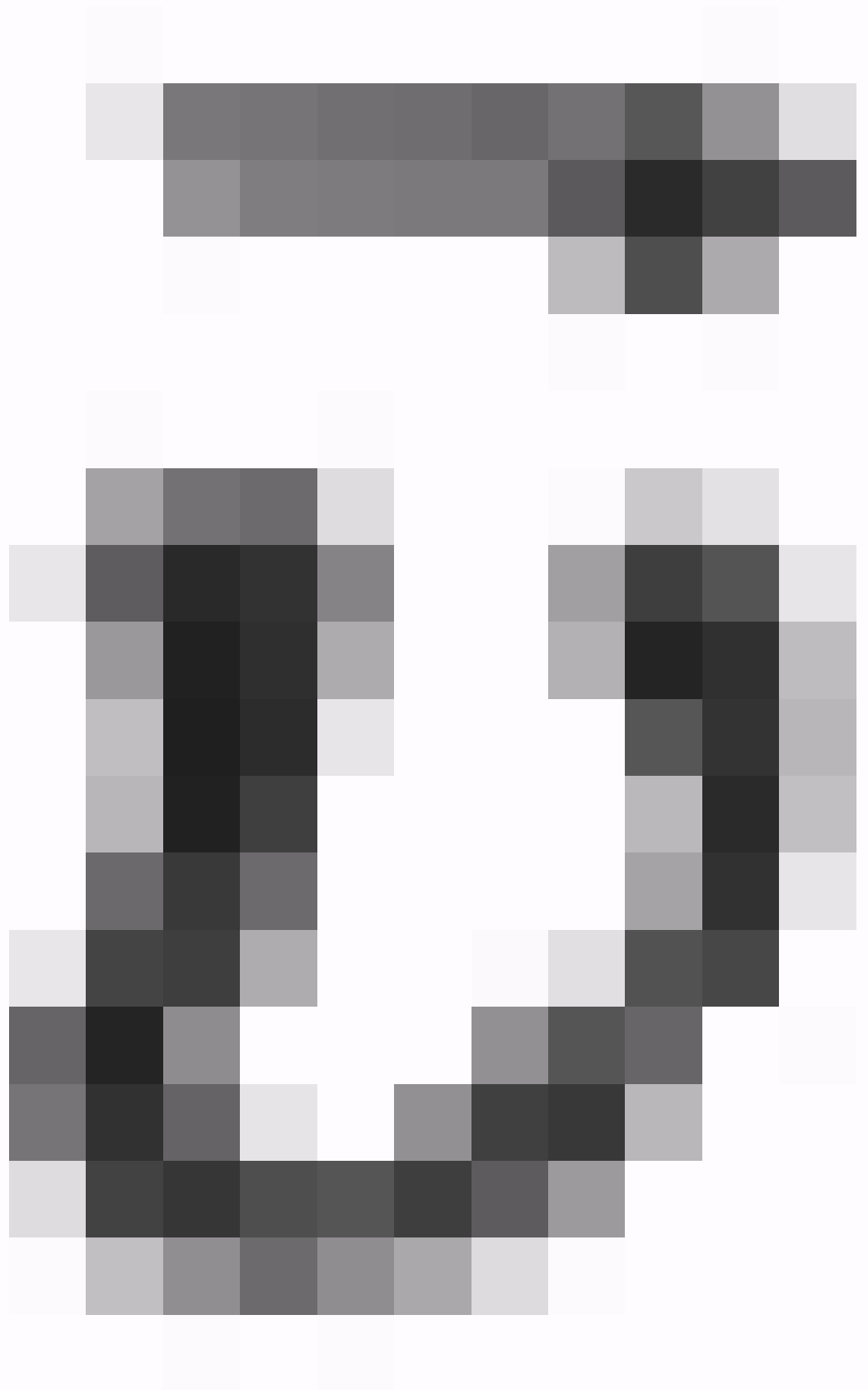

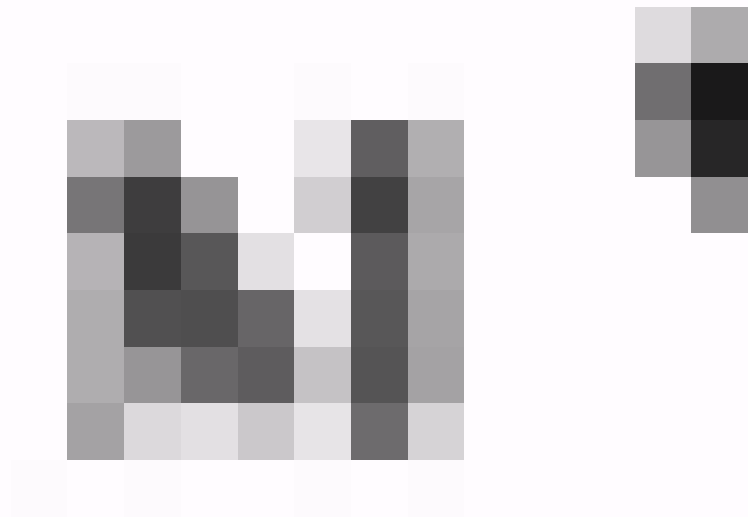
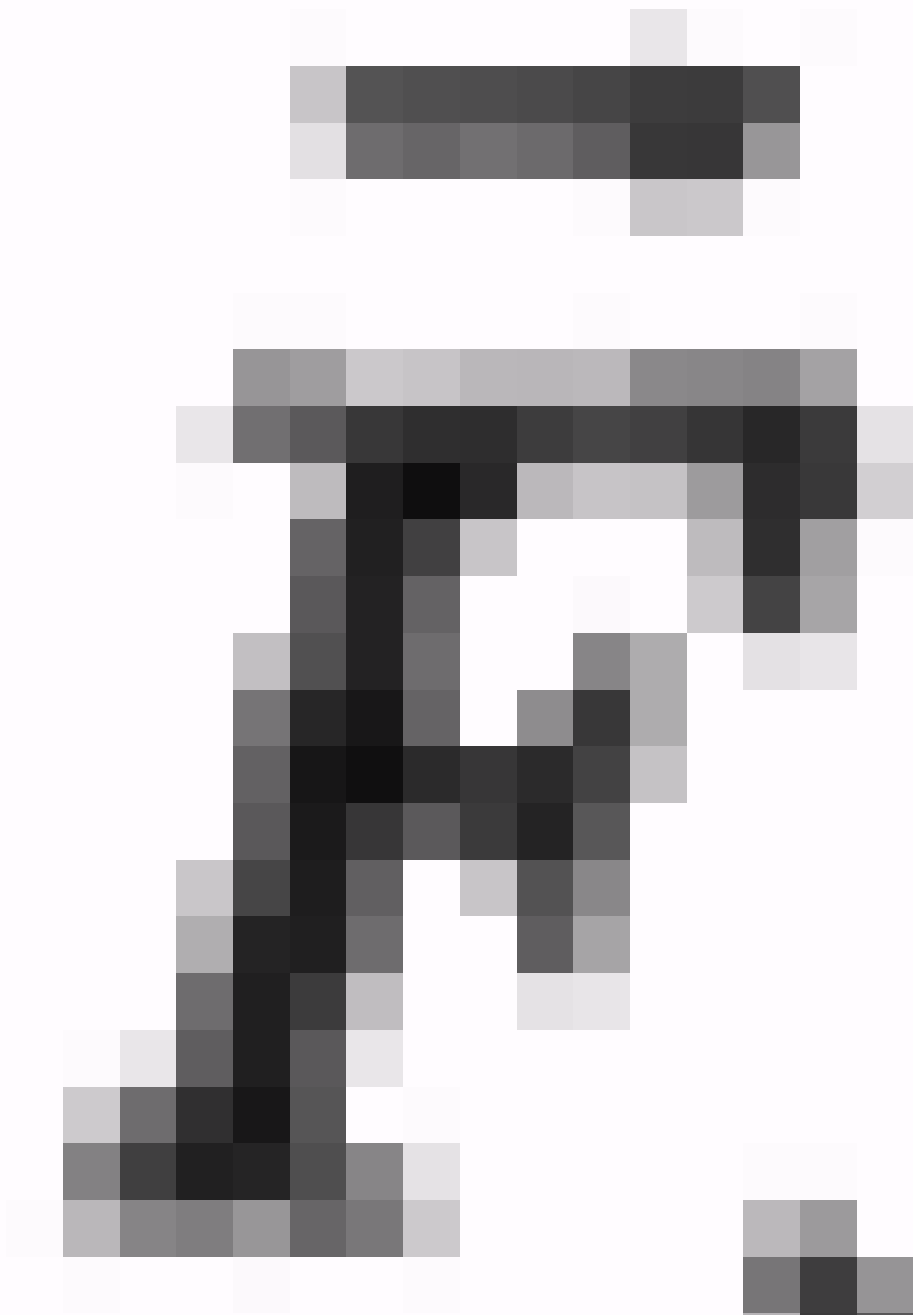

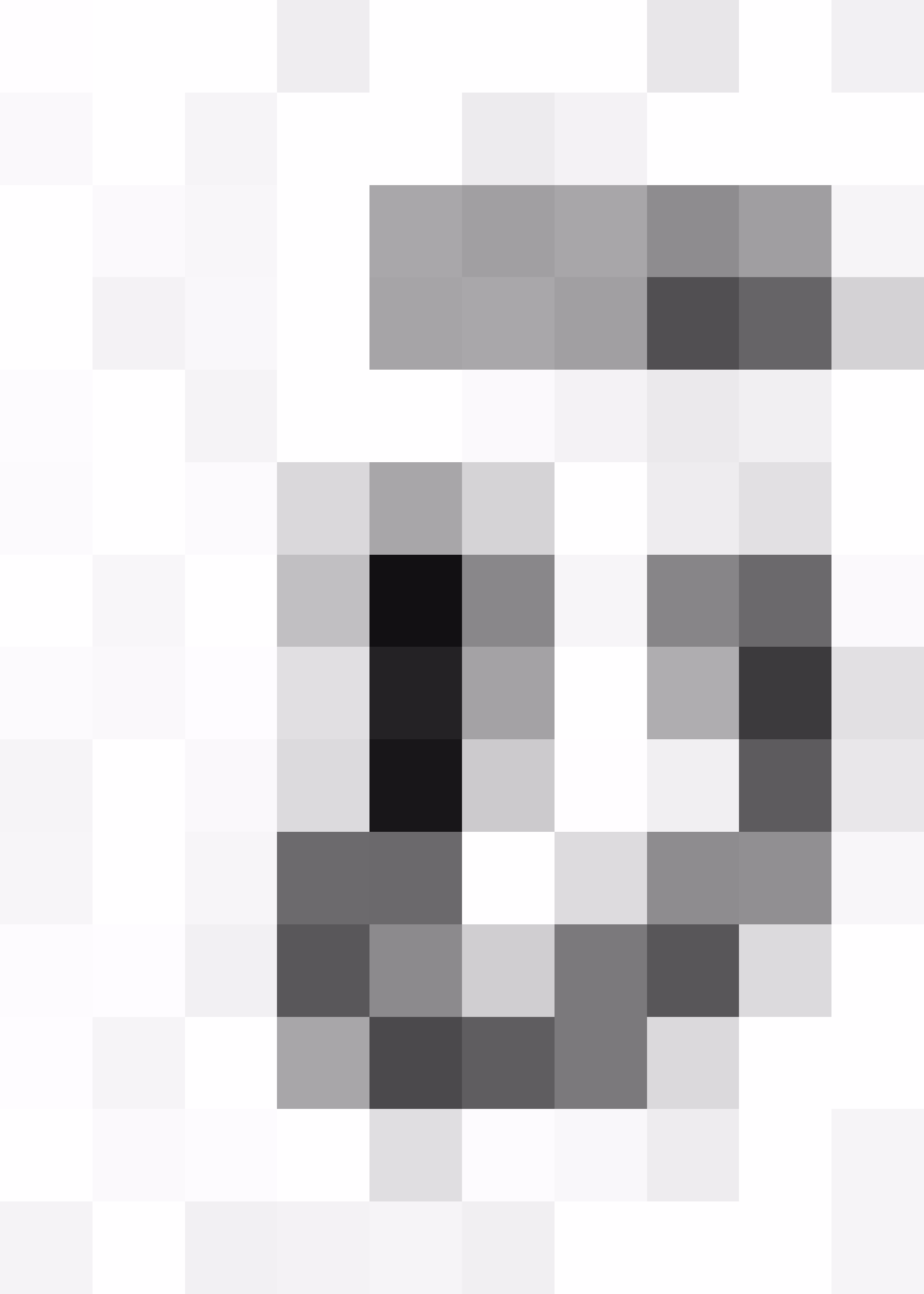

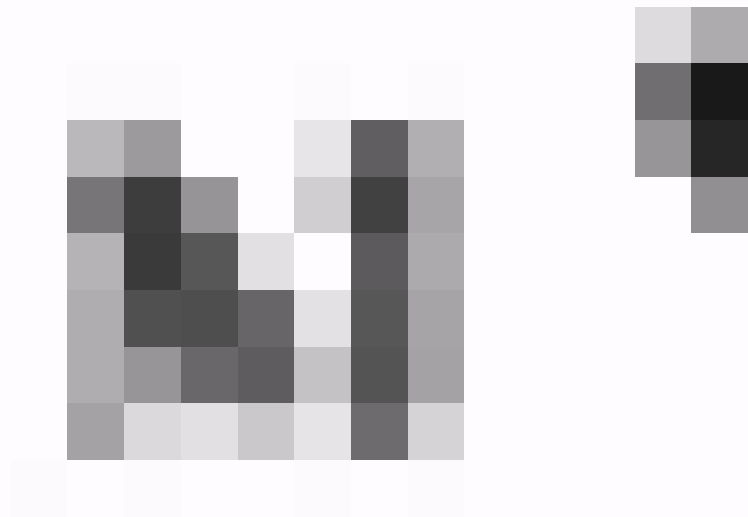
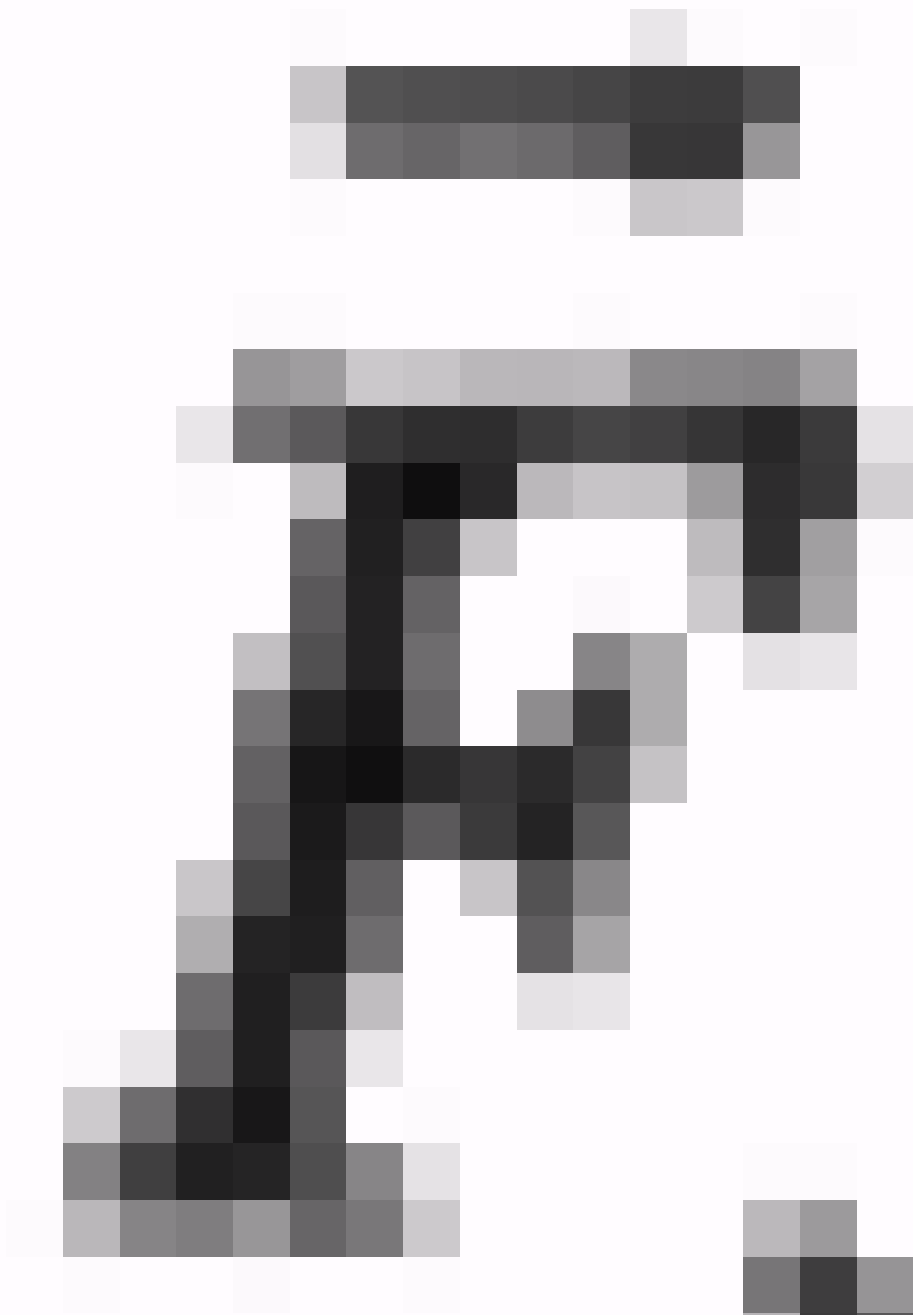

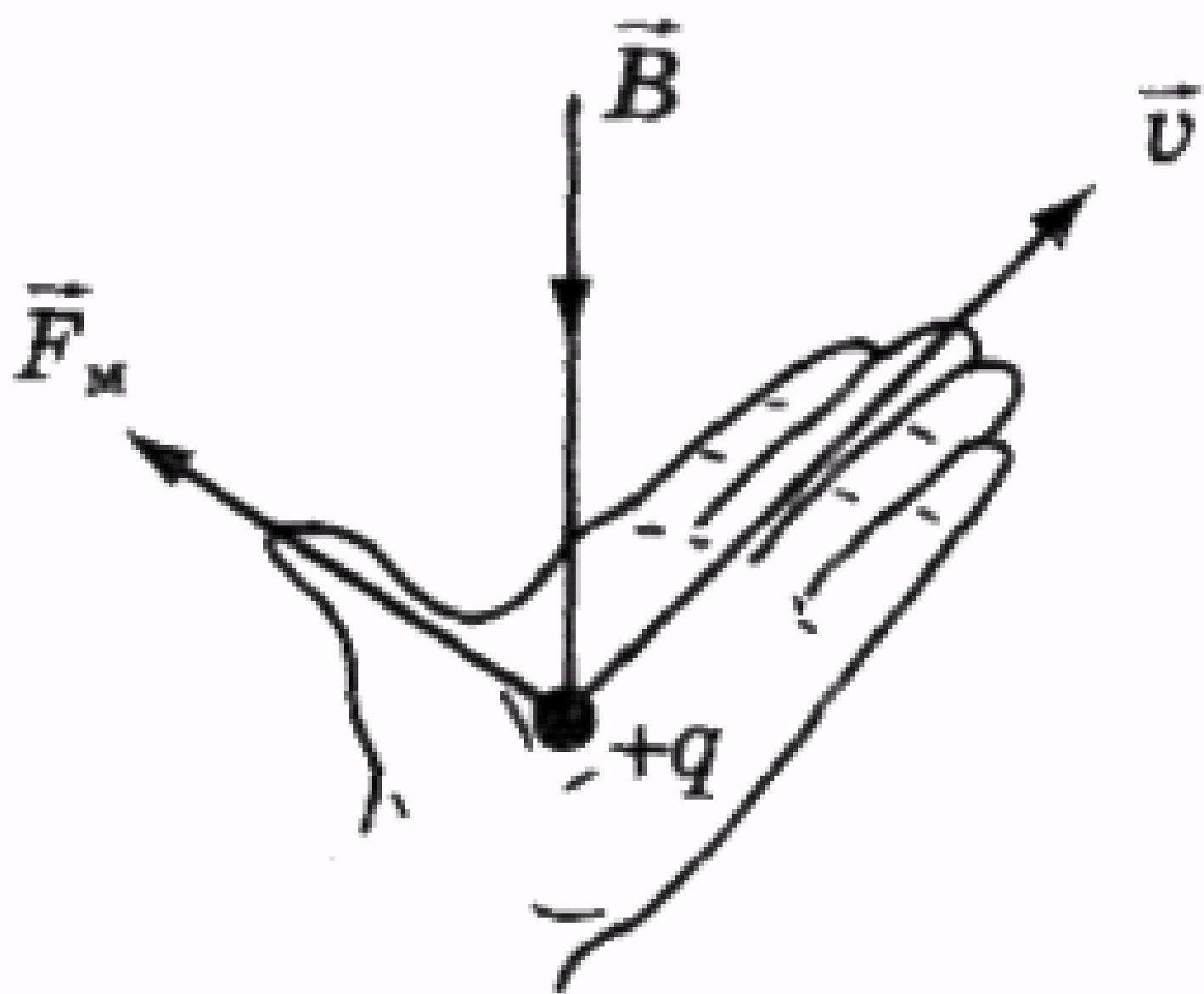

Мал. 2.140

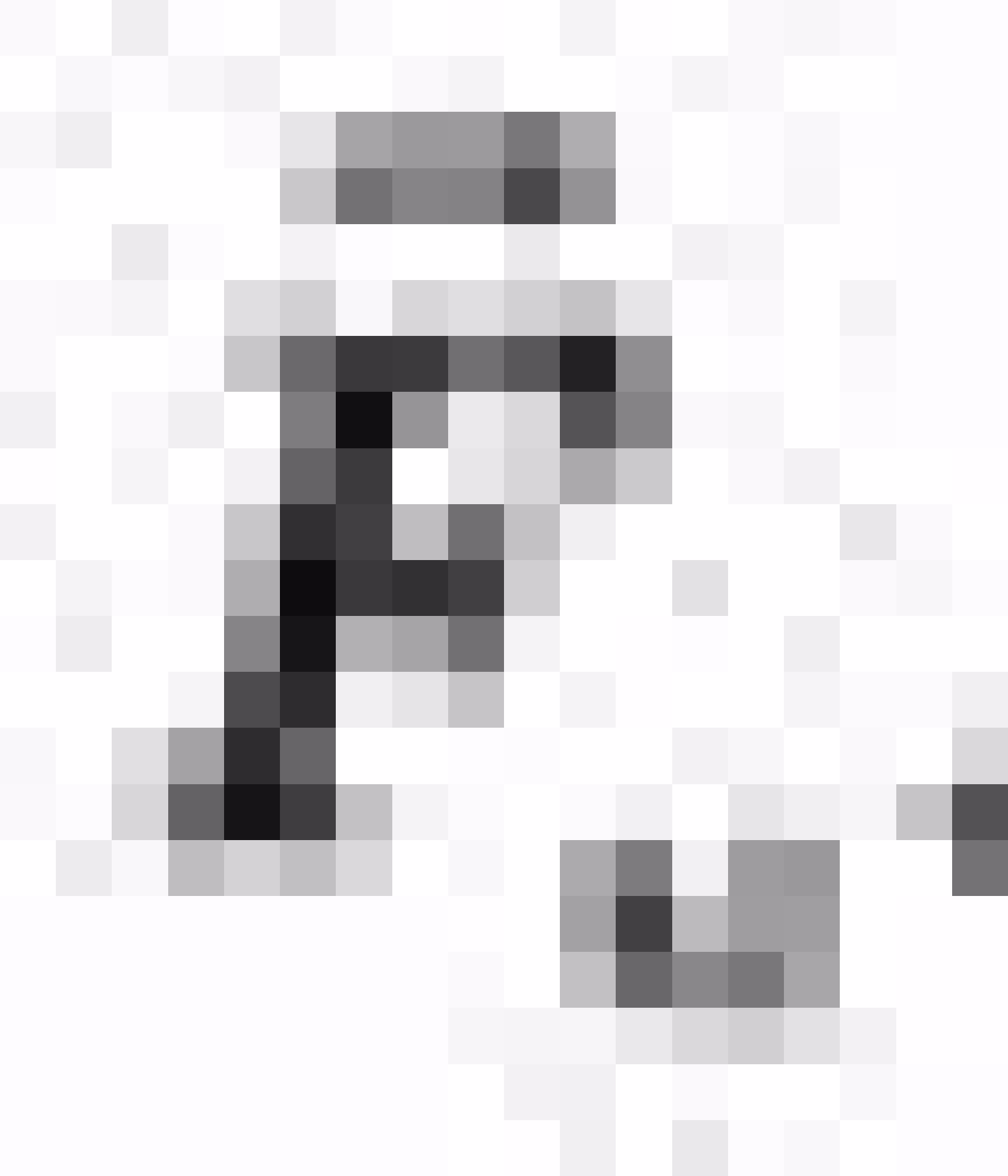

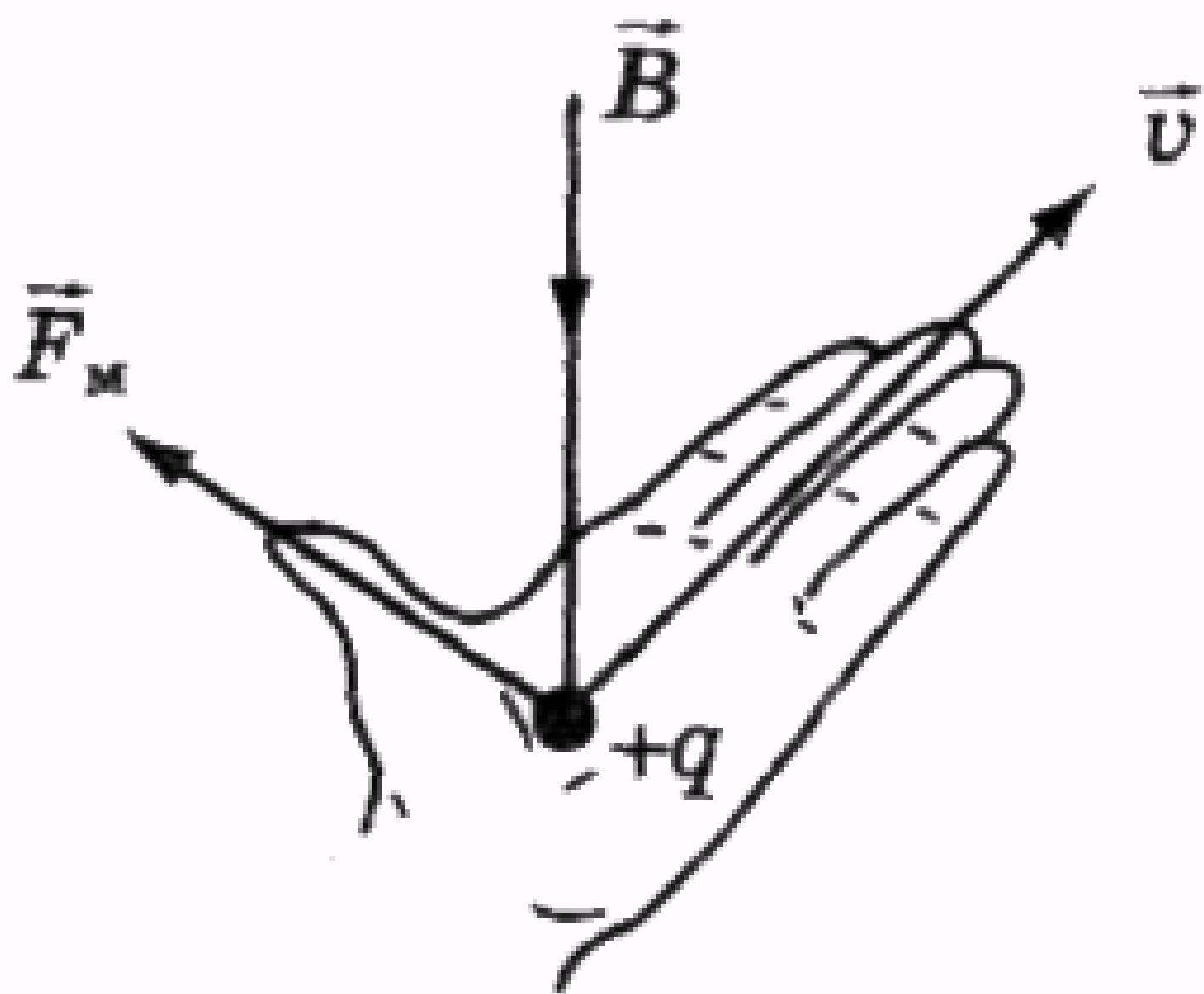

Мал. 2.140

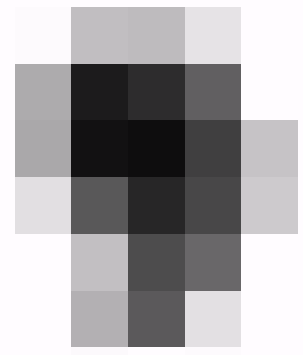
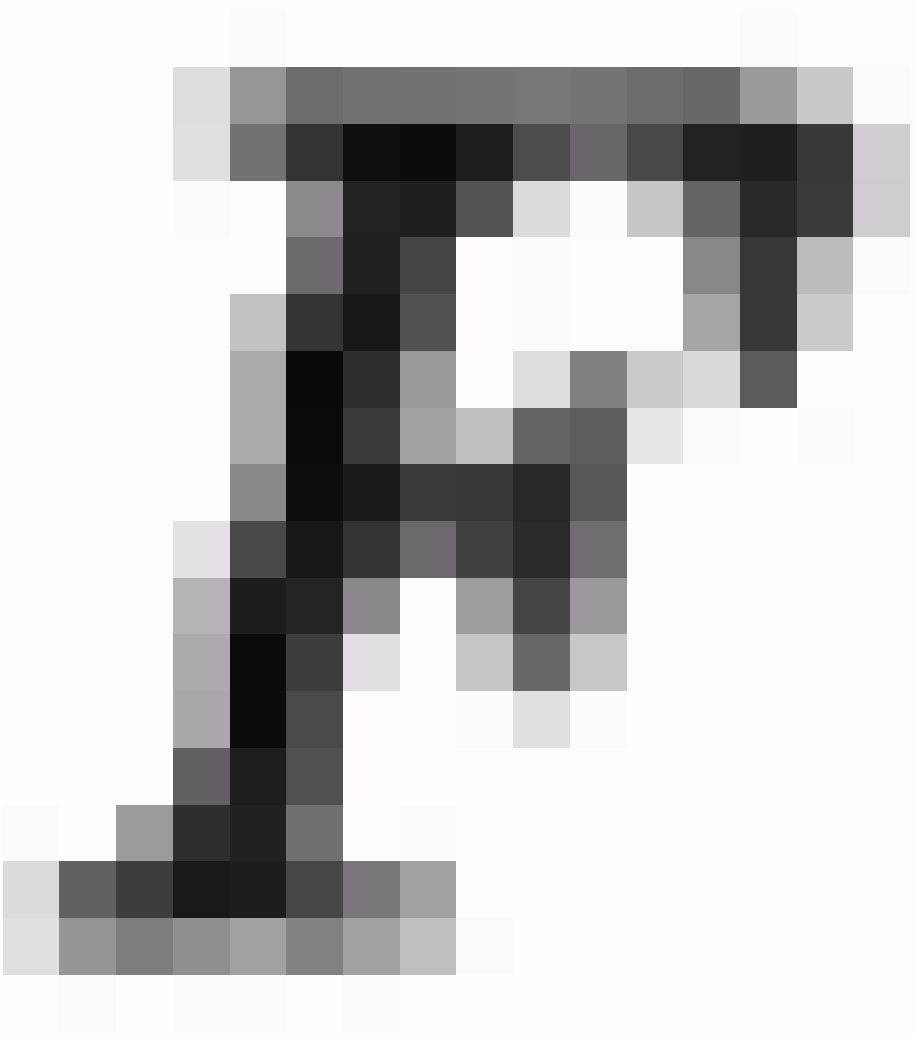
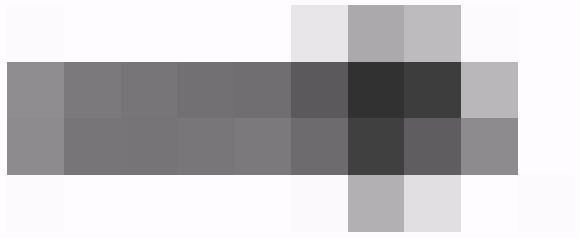

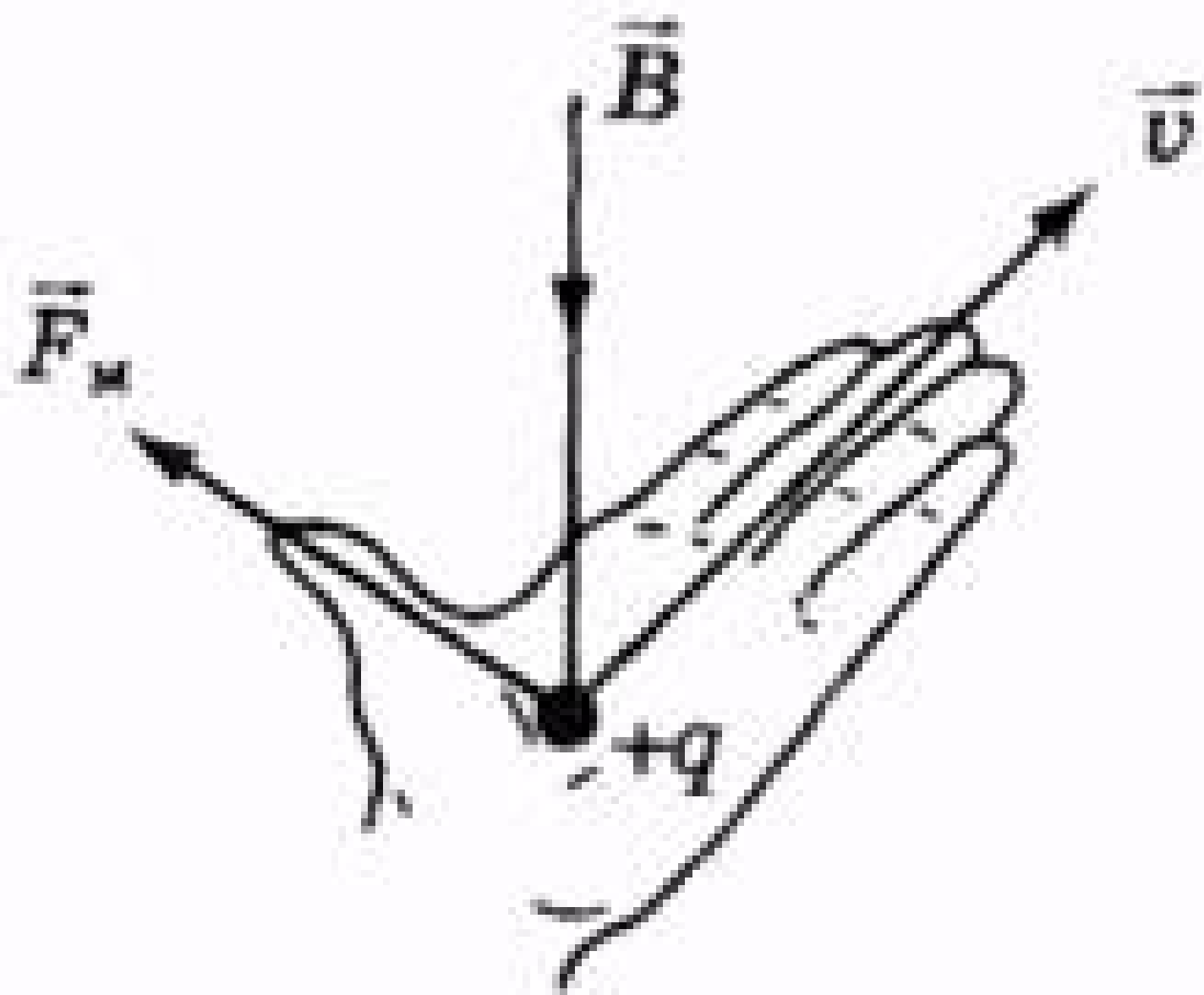

Mat. 2.140

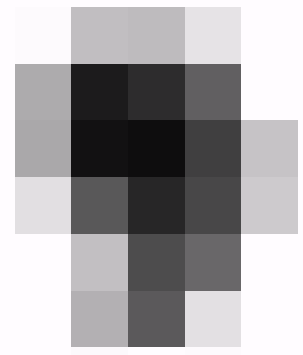
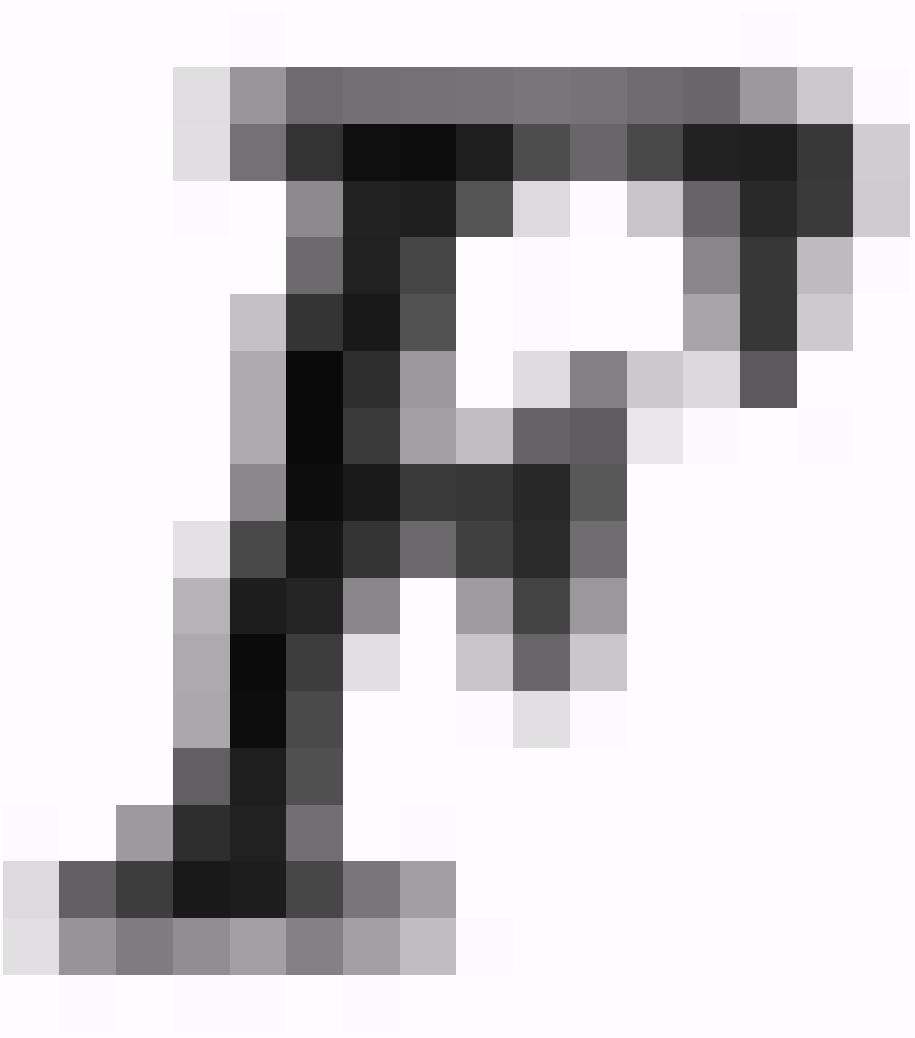
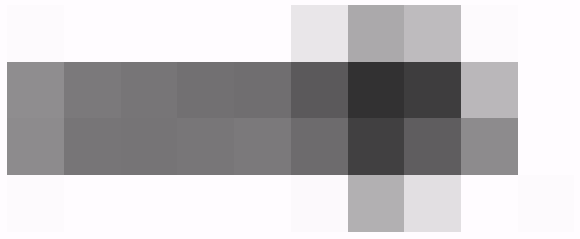

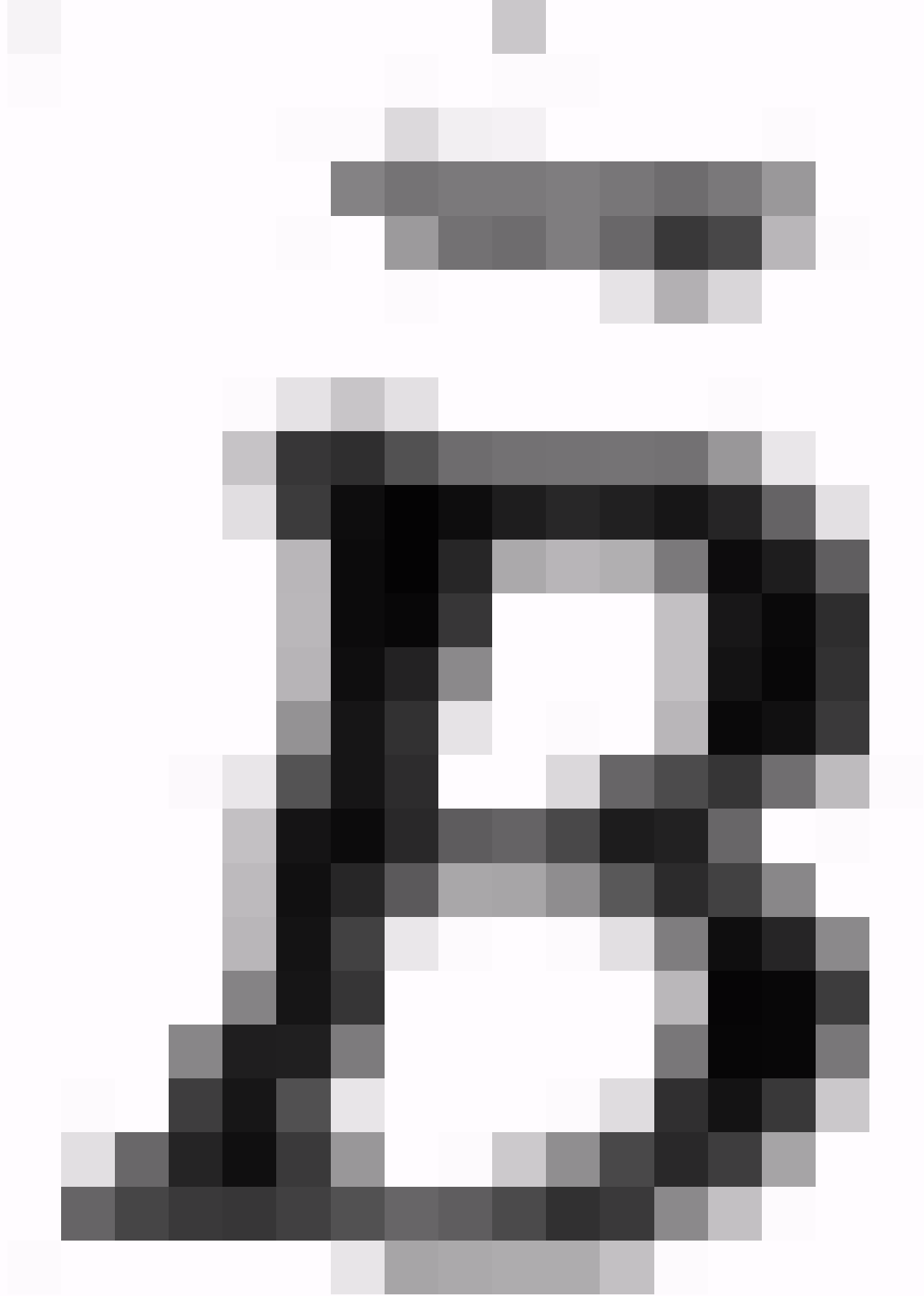



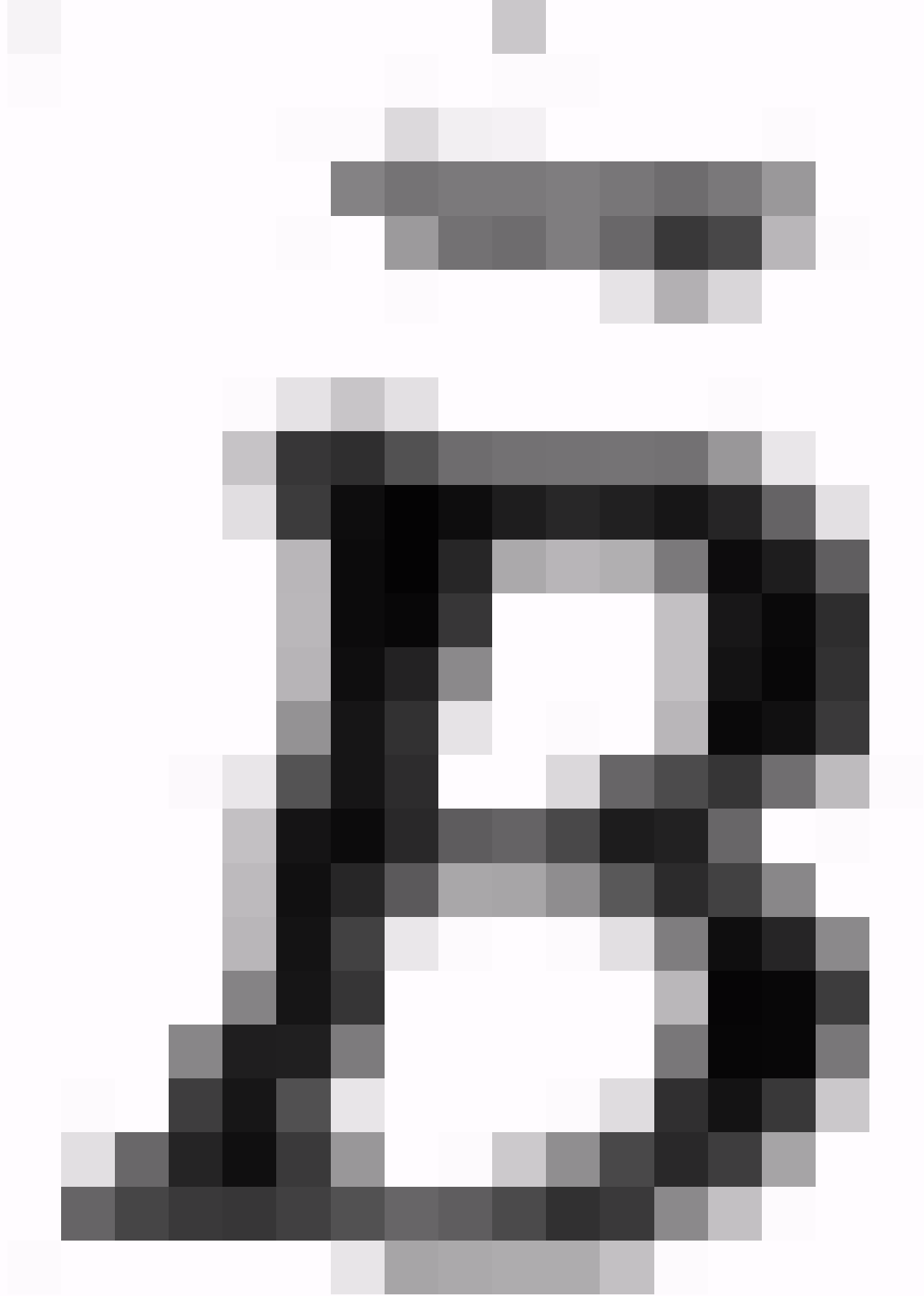

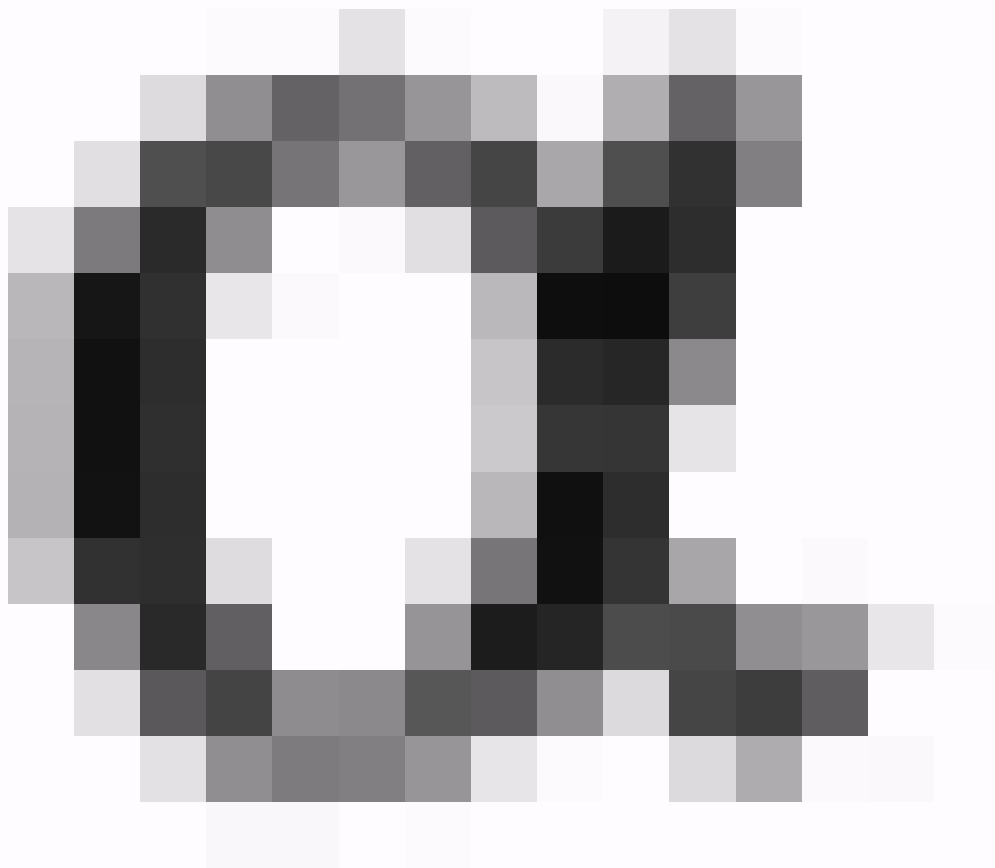

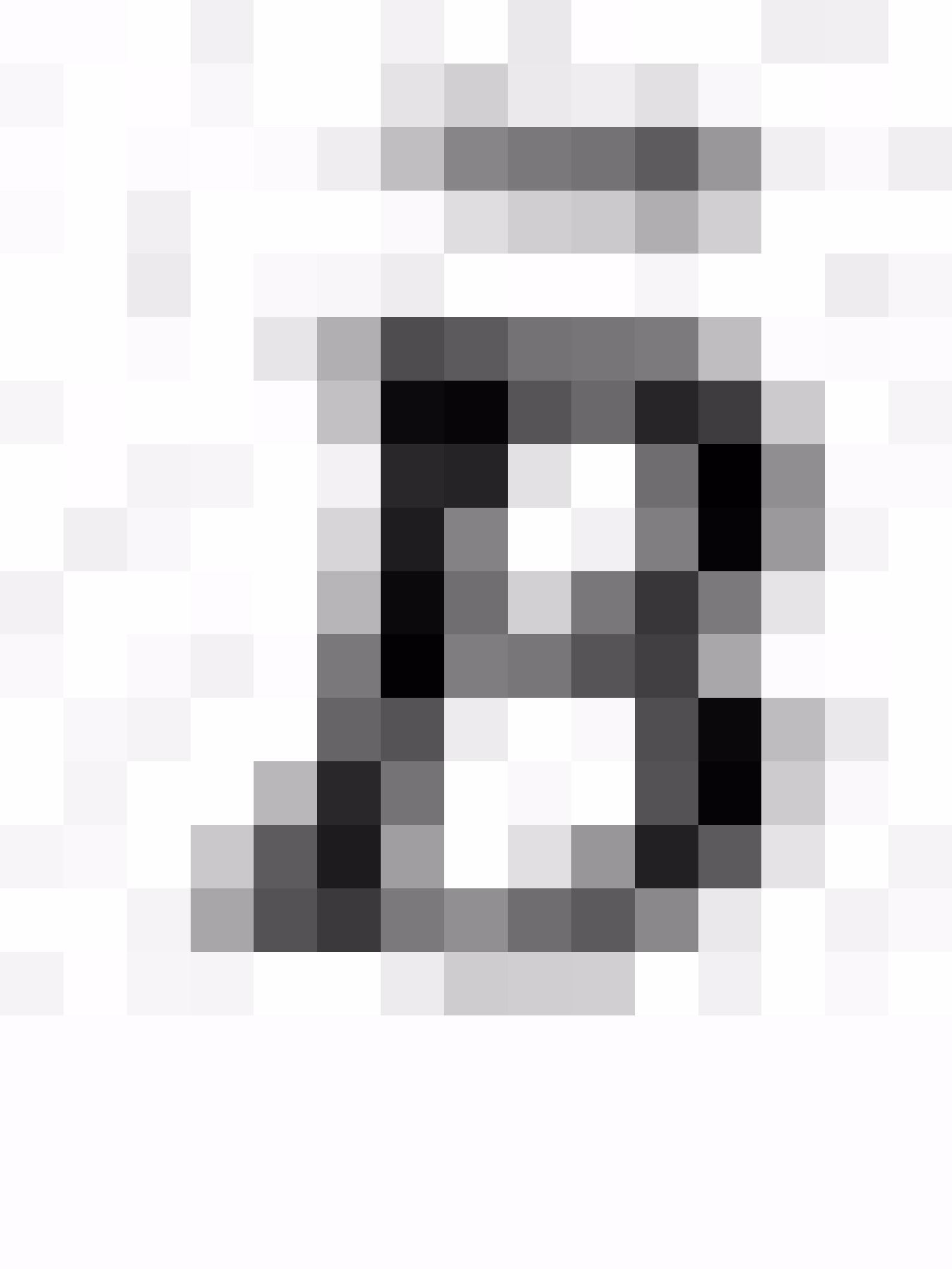

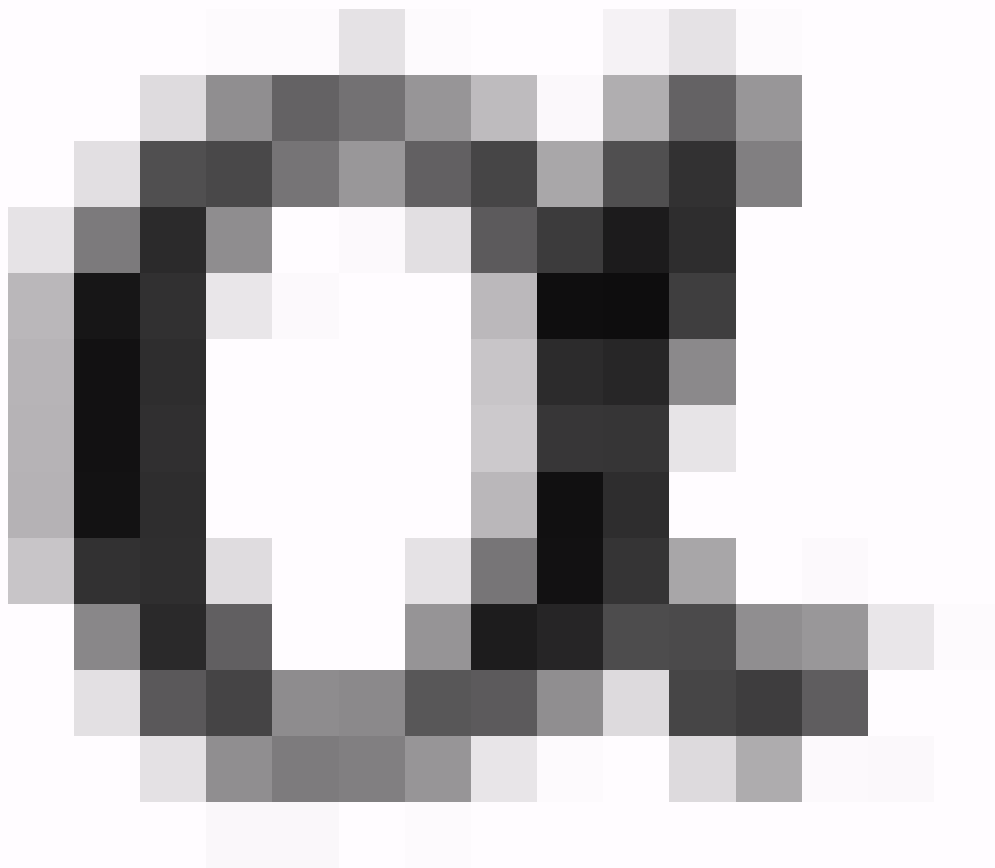

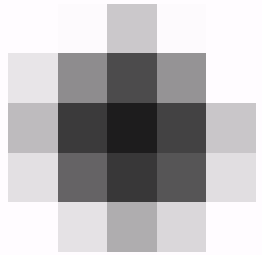
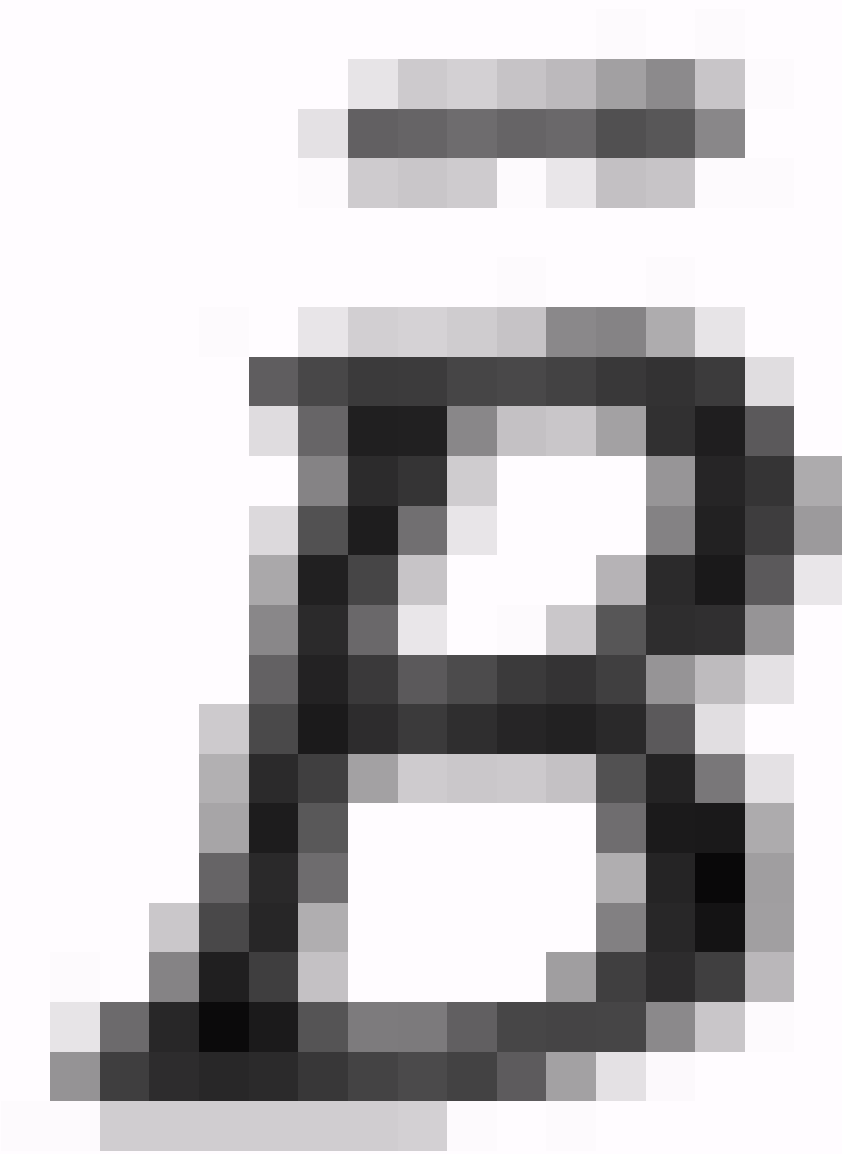

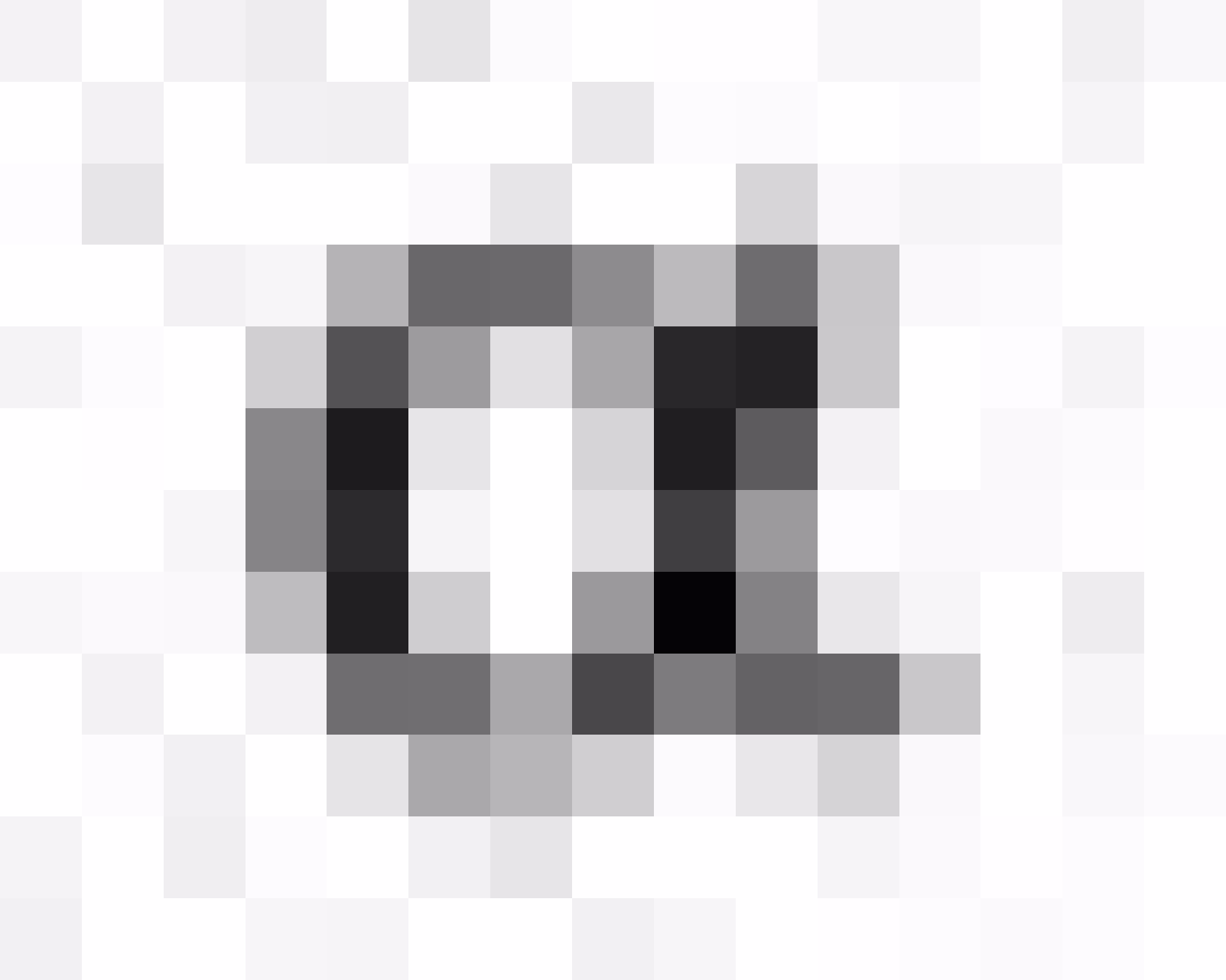

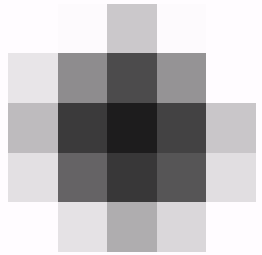
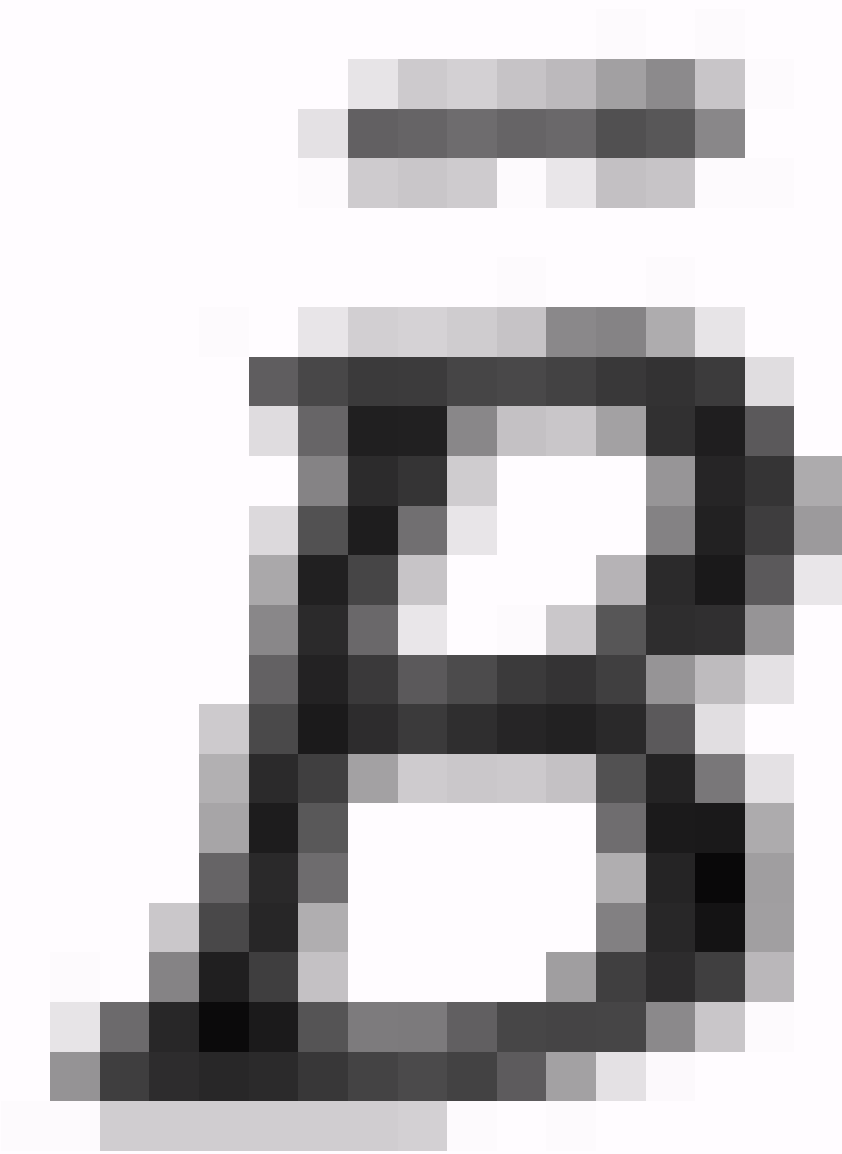

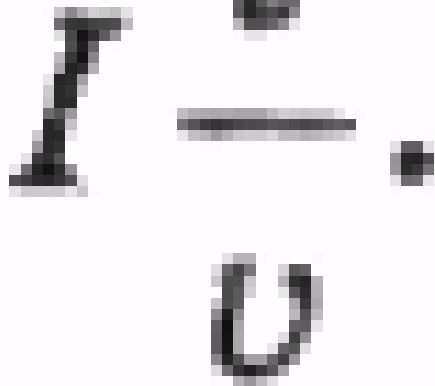
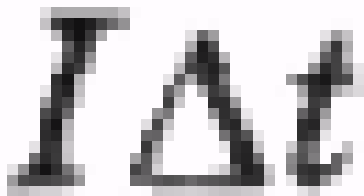



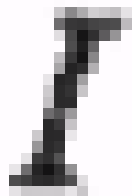
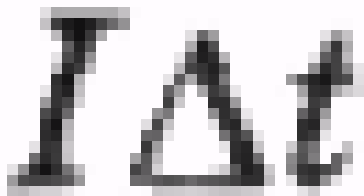

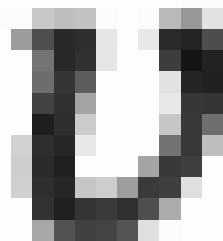
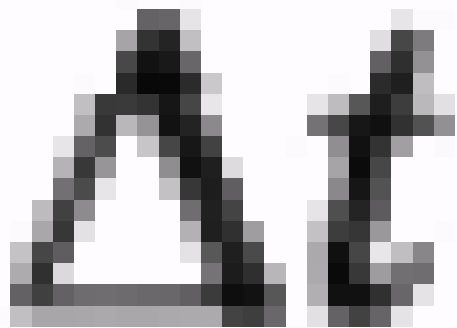



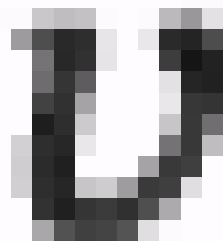
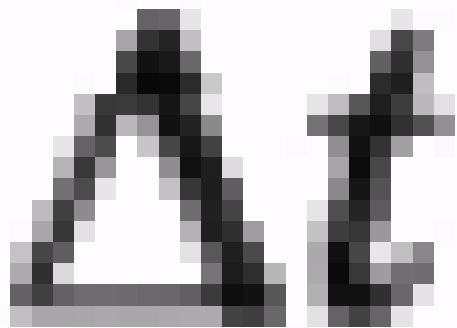

$$F = qBv \sin \alpha \equiv I \frac{L}{v} Bv \sin \alpha = IBL \sin \alpha.$$



$$F = qBv \sin \alpha \equiv I \frac{L}{v} Bv \sin \alpha = IBL \sin \alpha.$$



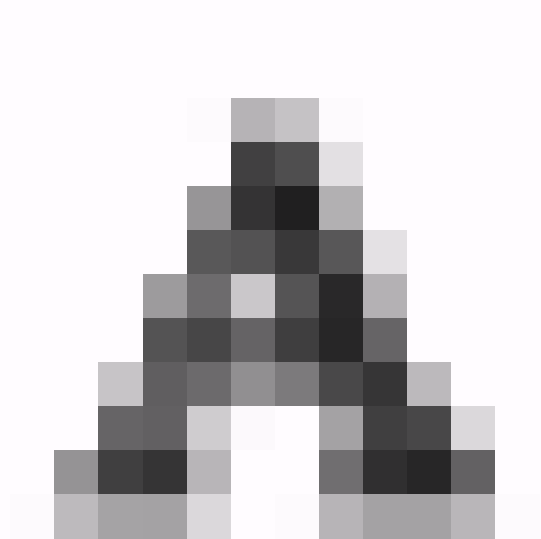
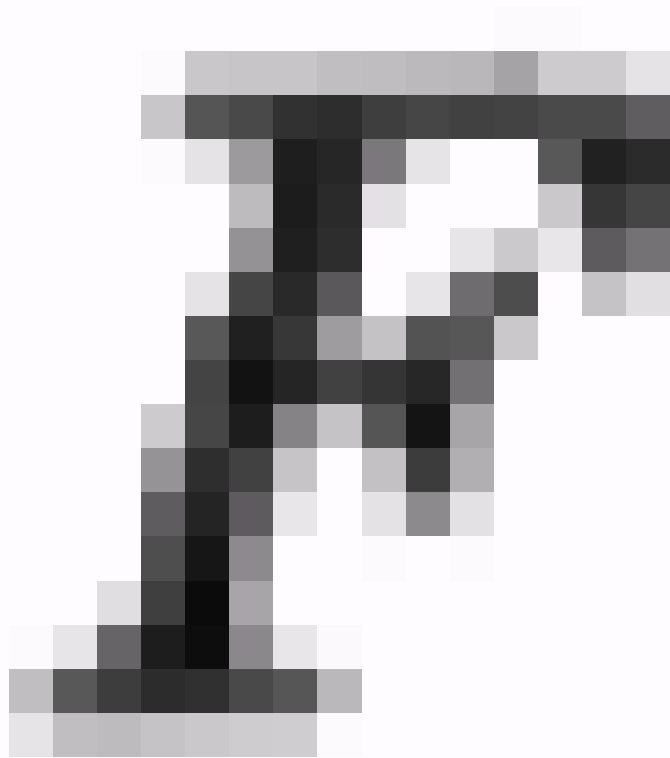

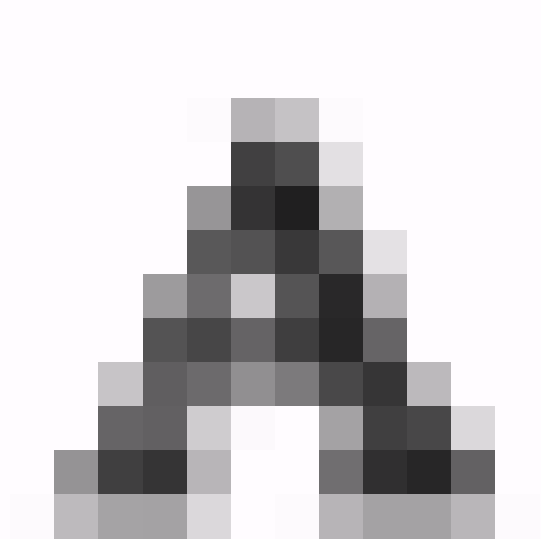
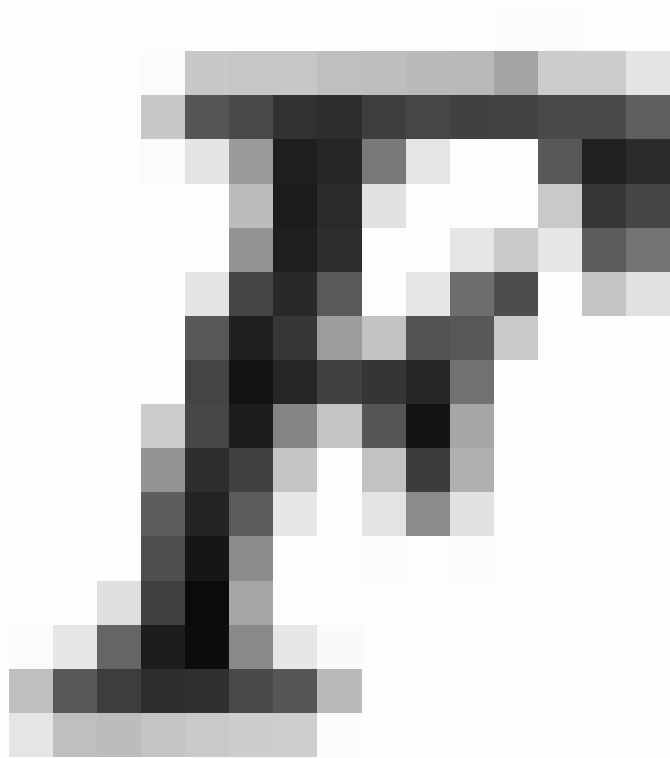

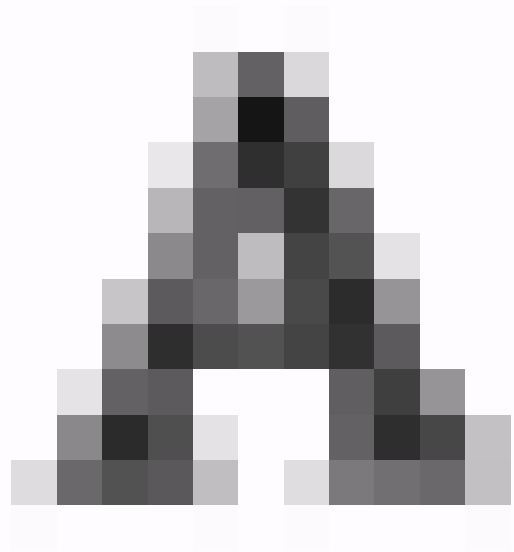

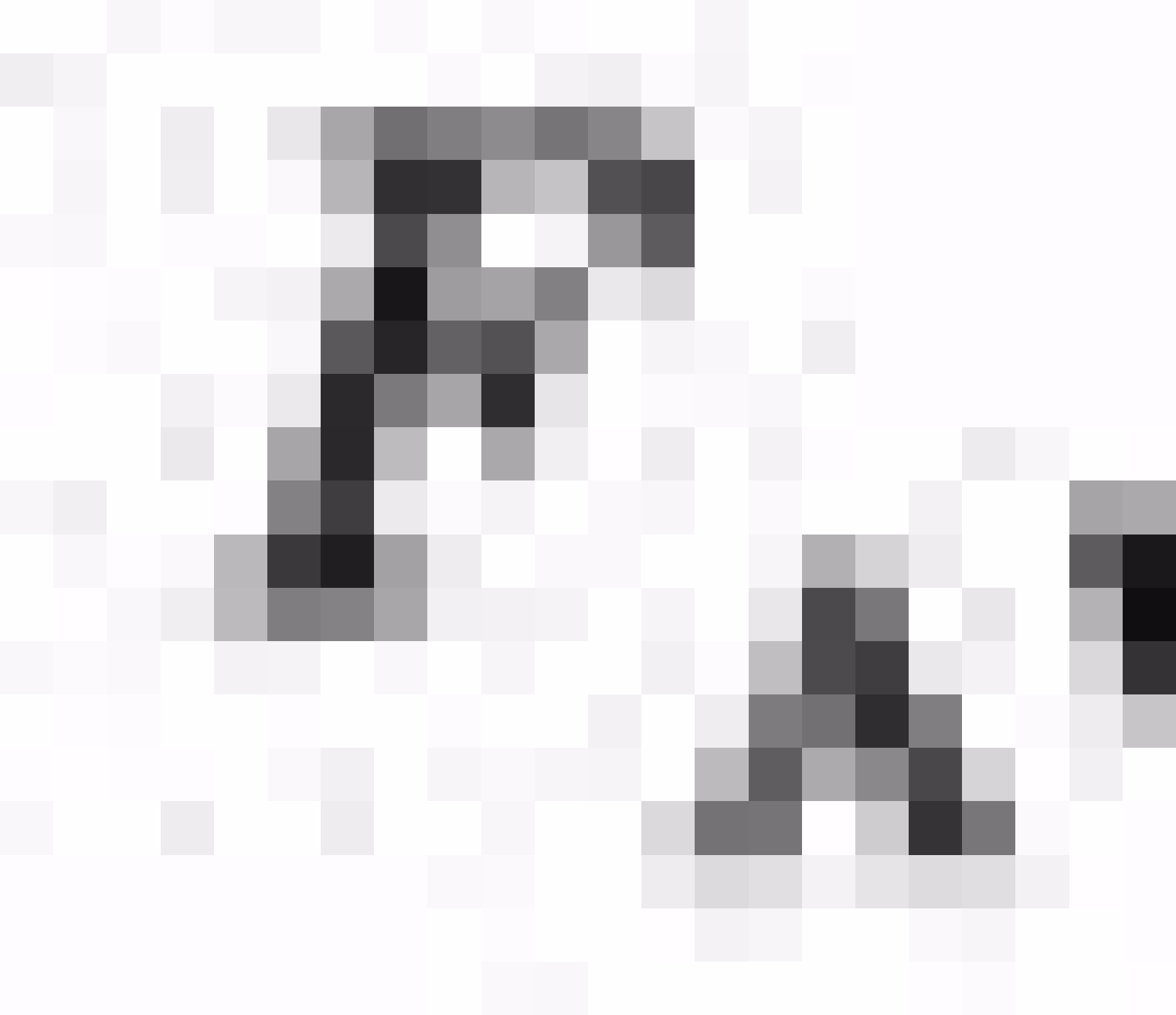

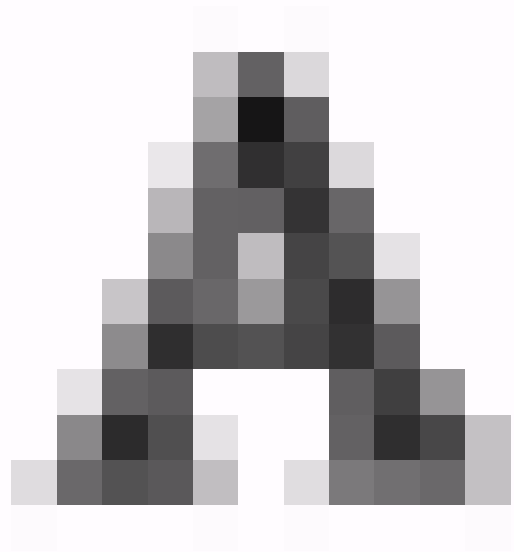
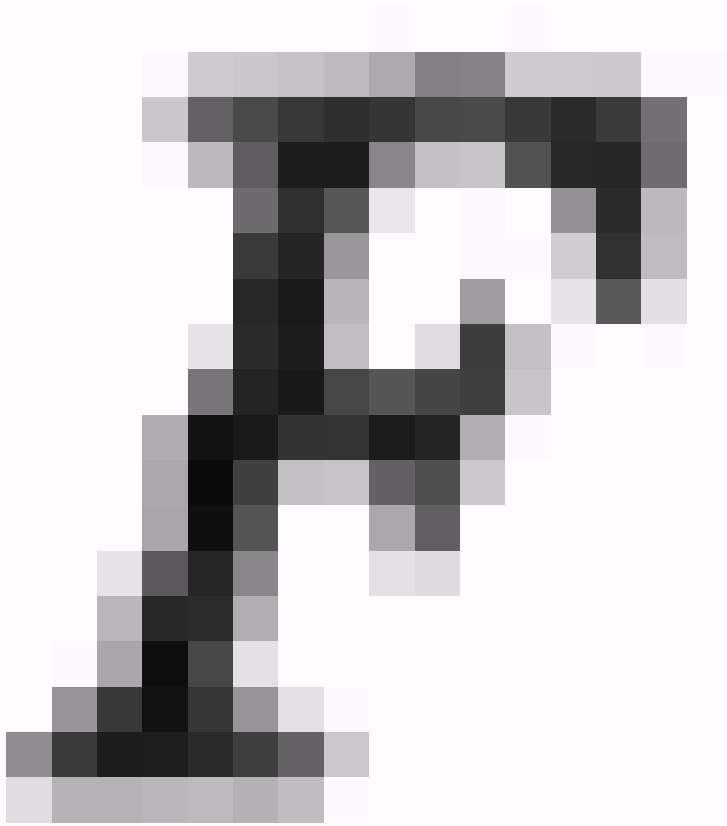

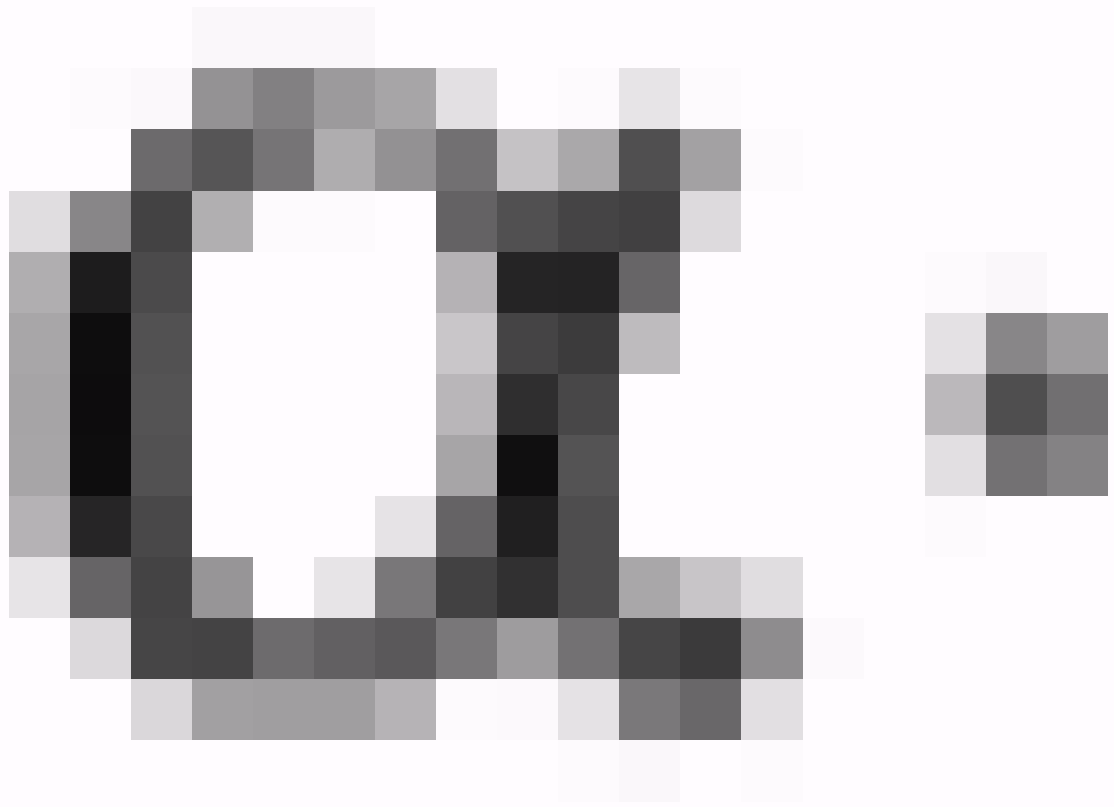

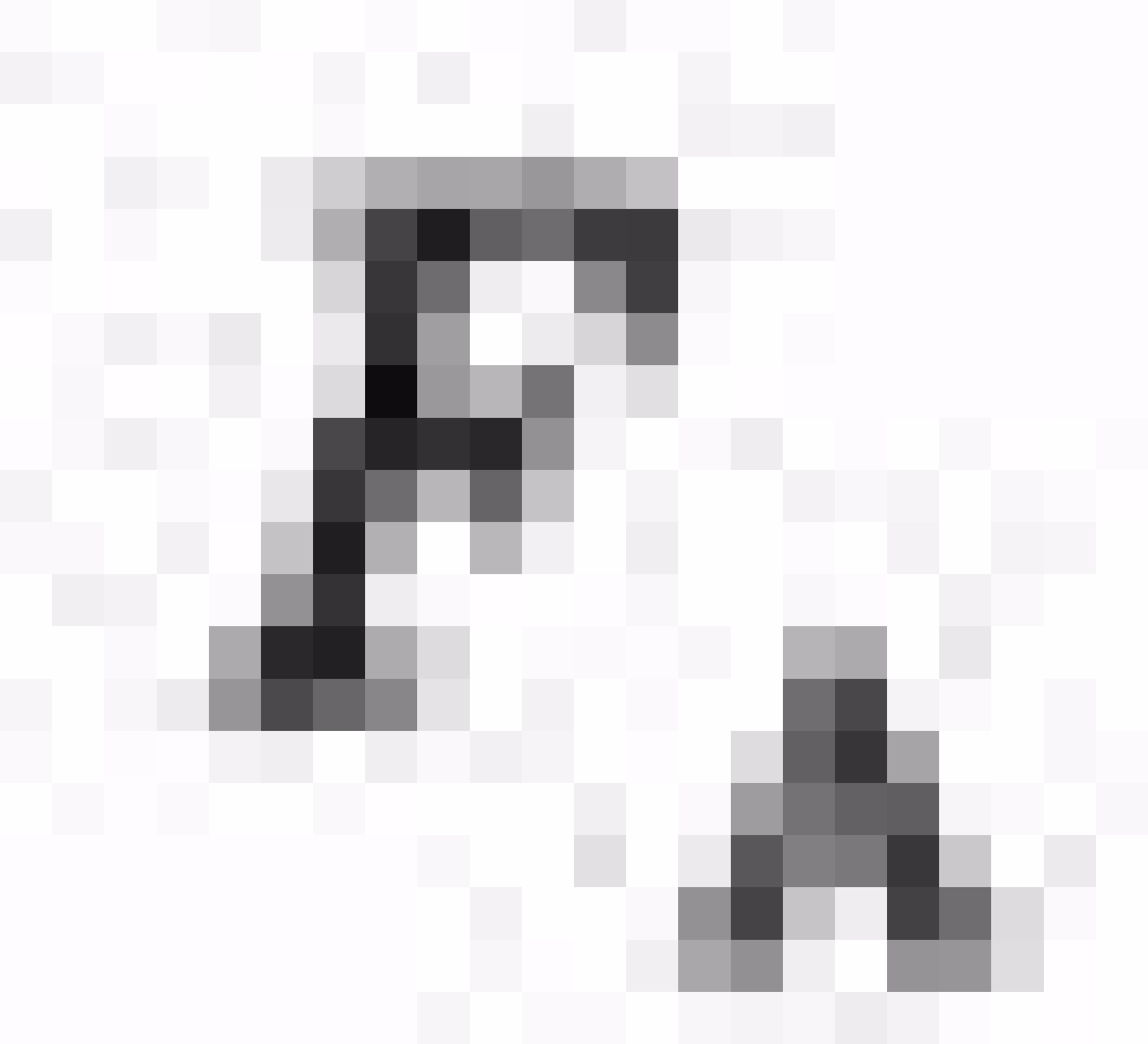

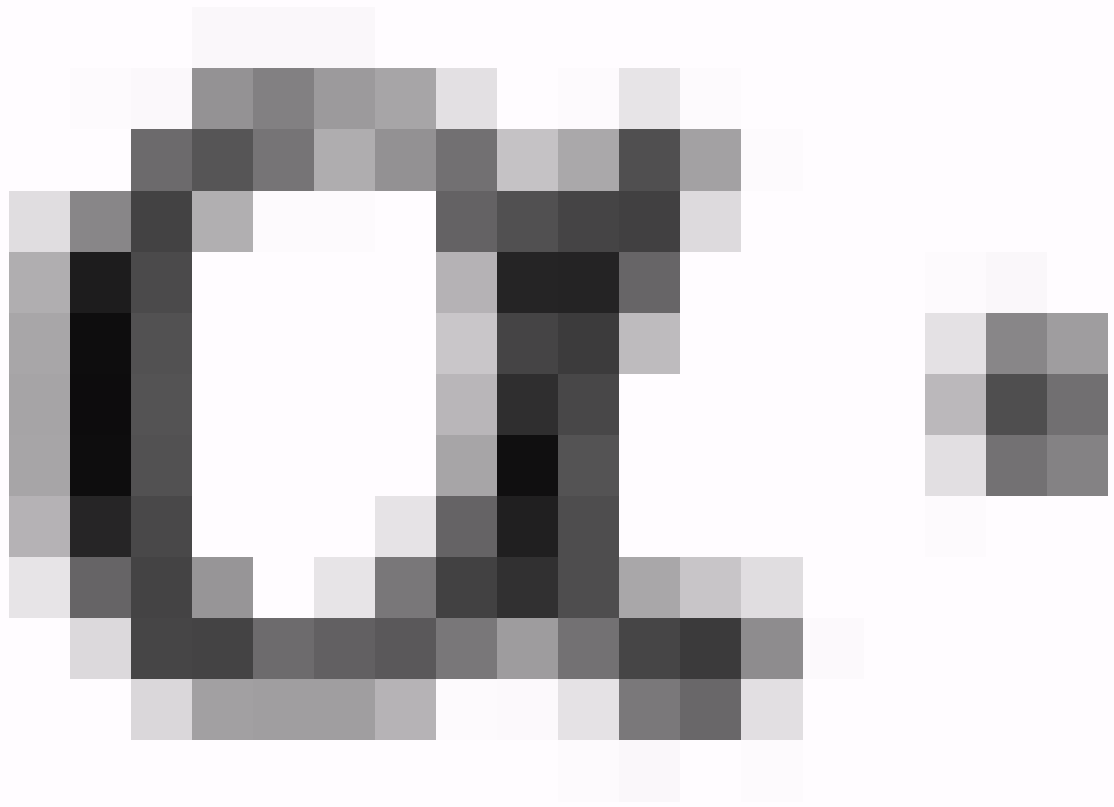

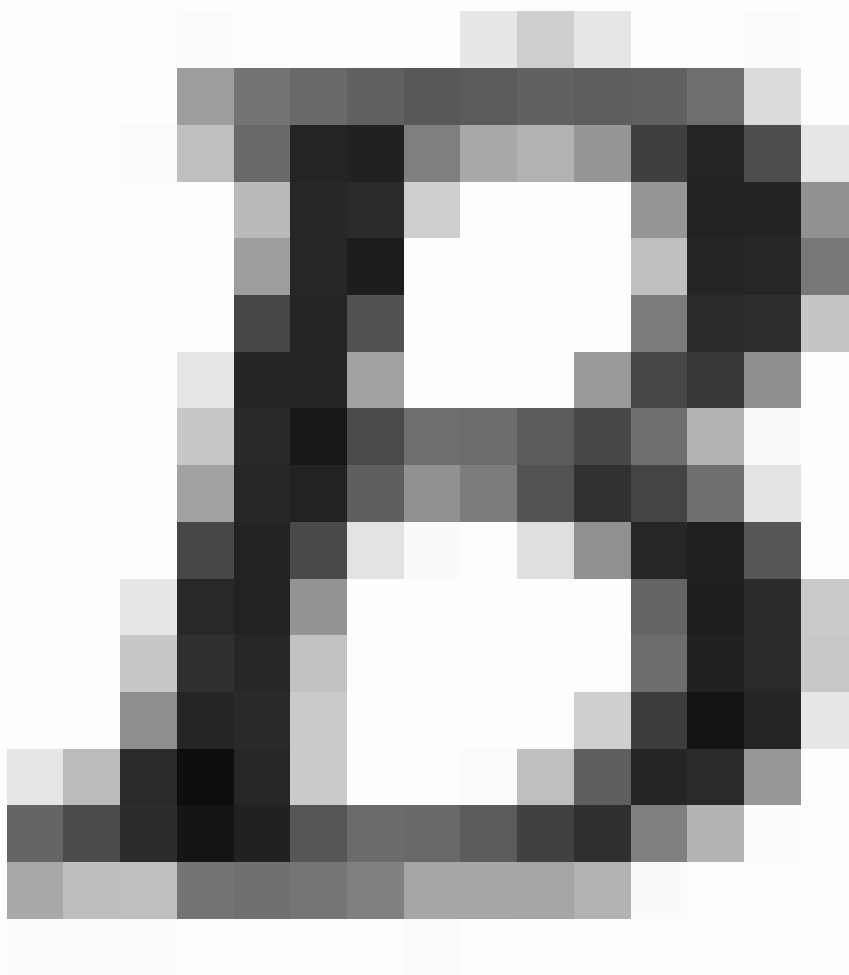
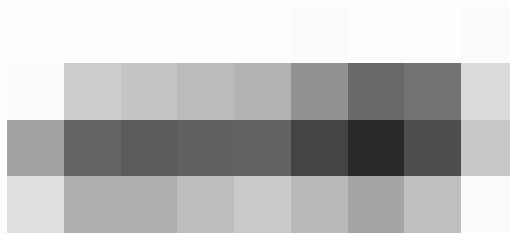

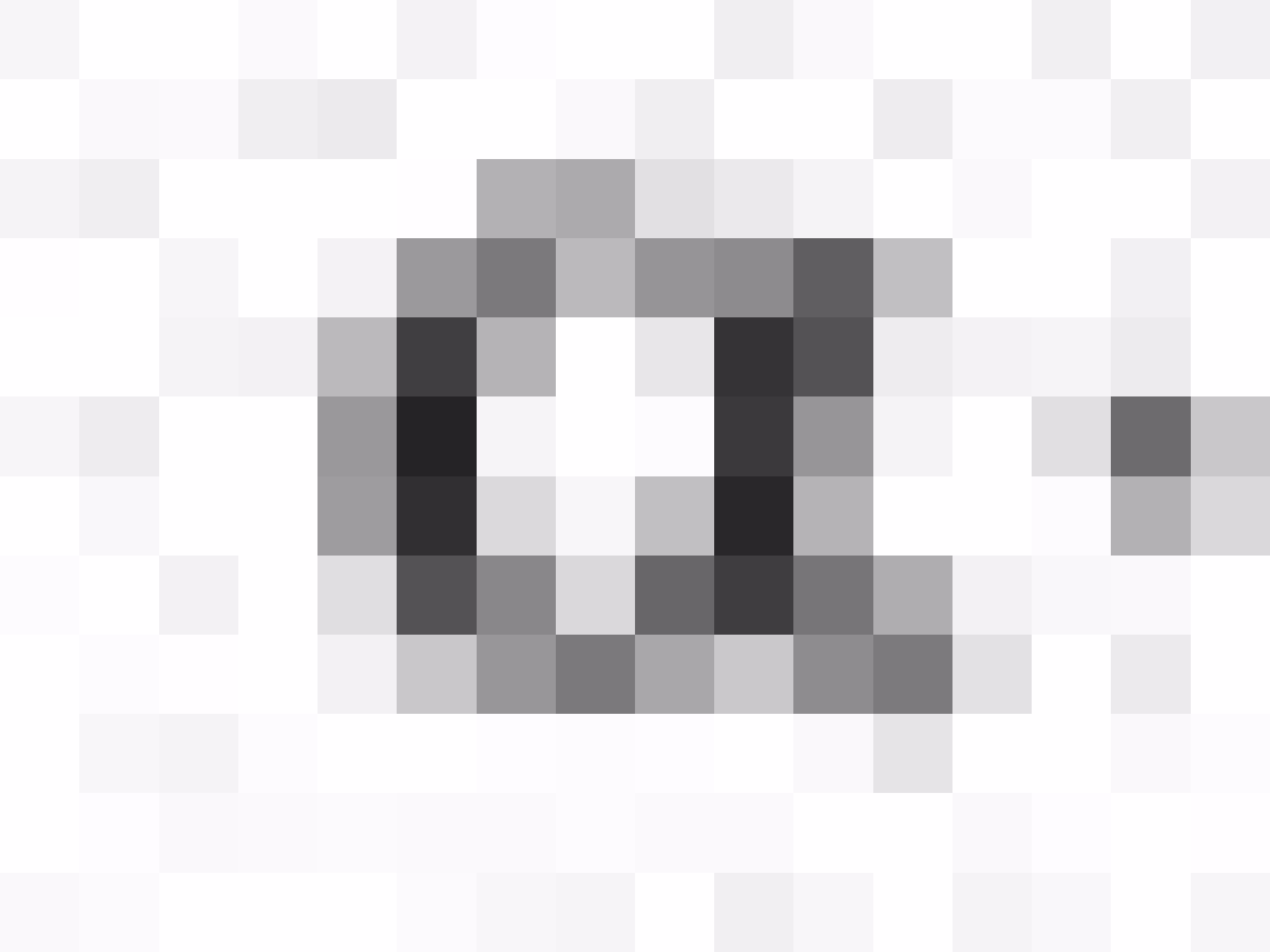

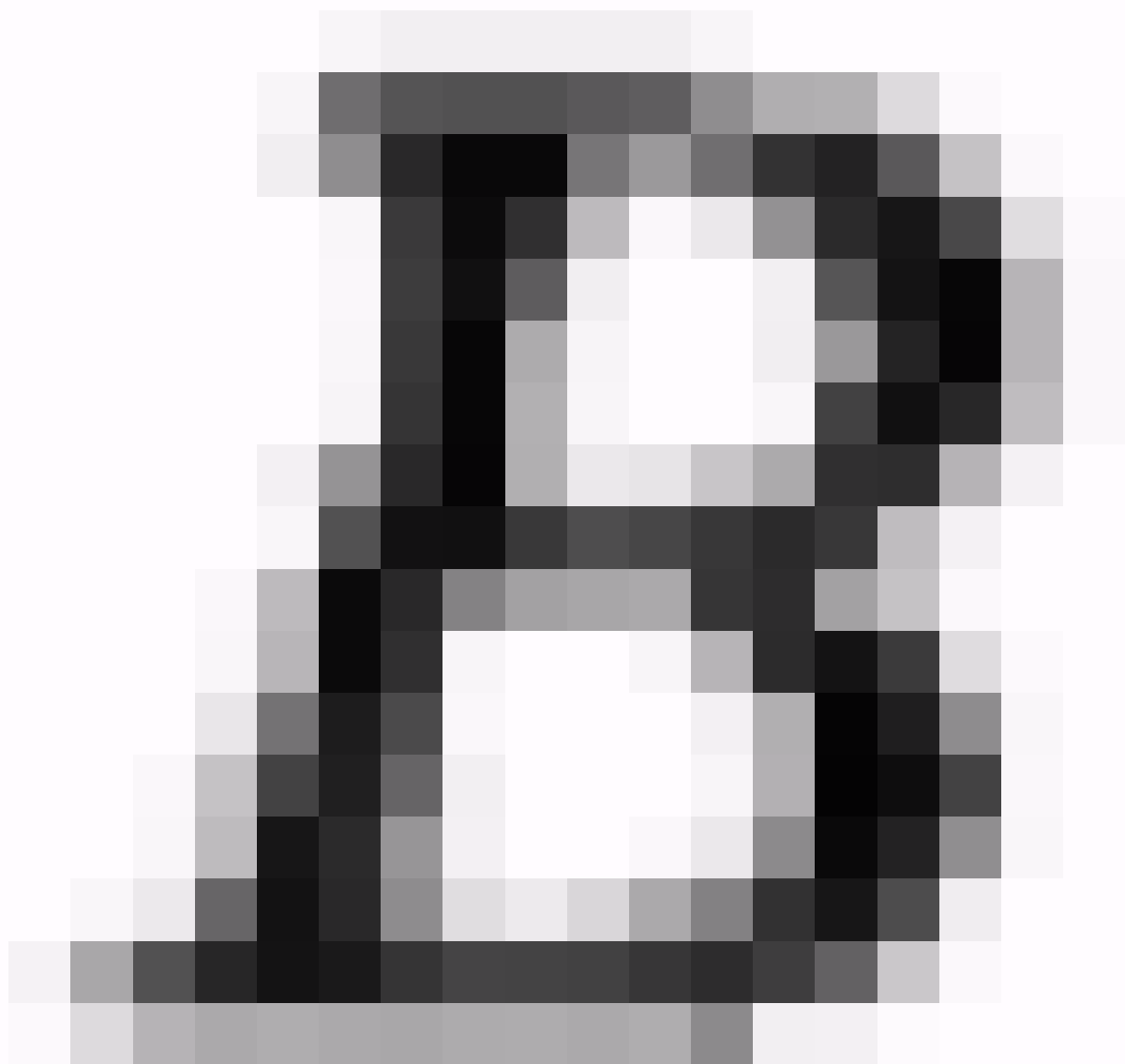
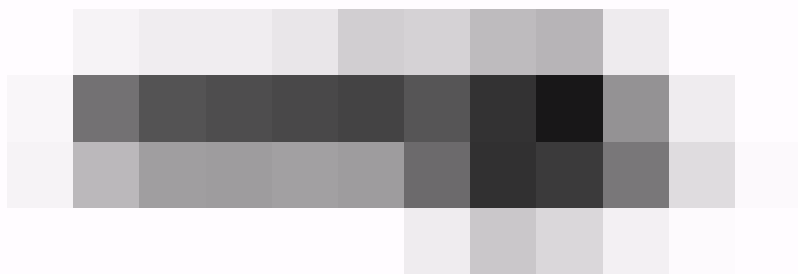

Qilin

Q

=

Ilis

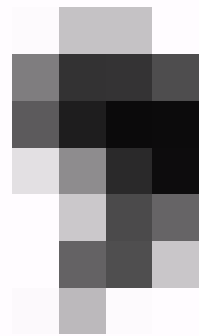
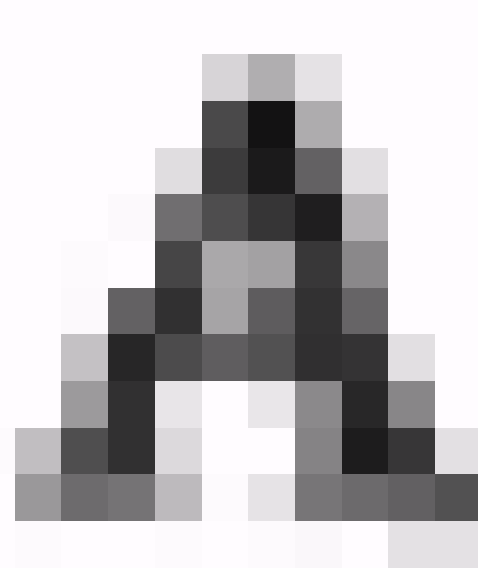

$$B = \frac{FA}{l \sin \alpha}, \quad \Gamma \pi = \frac{1H}{1A \cdot 1N}.$$

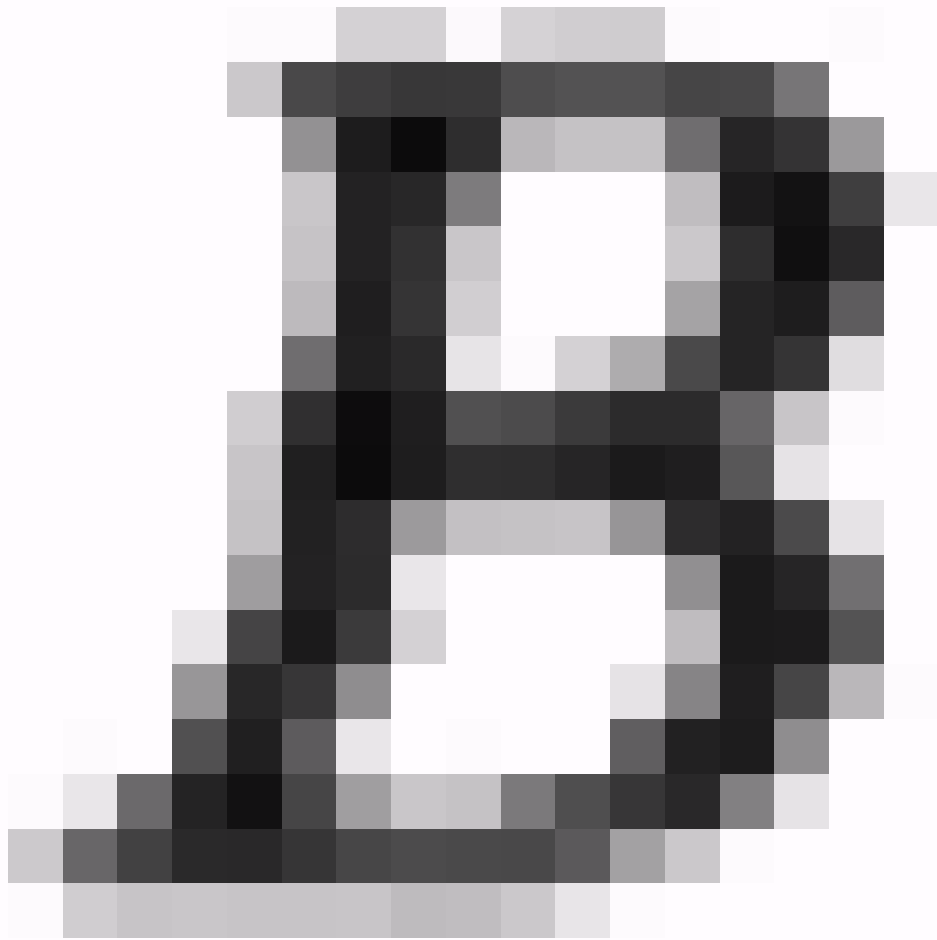

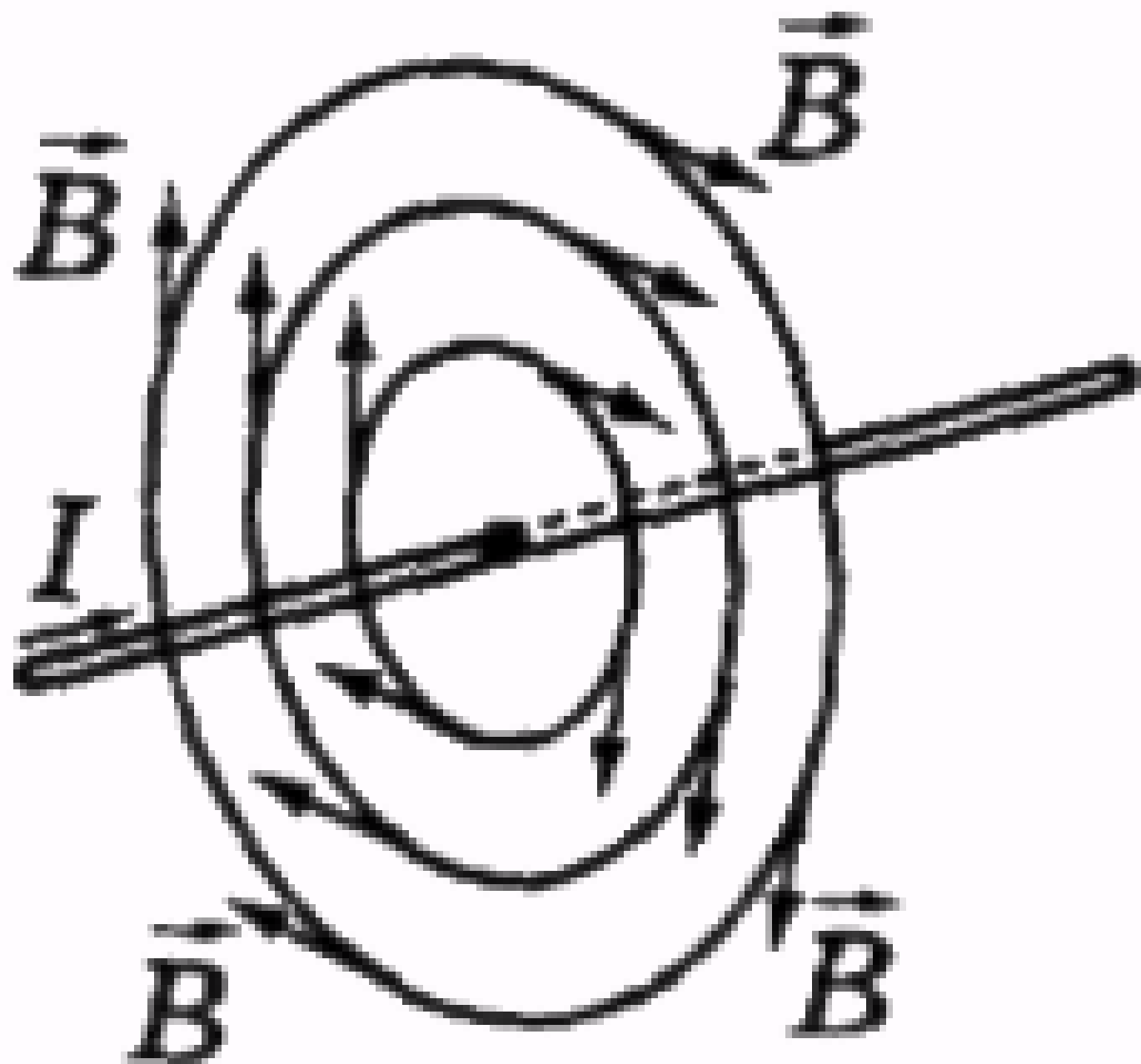

Мал. 2.141

THE UNIVERSITY OF
MICHIGAN LIBRARY

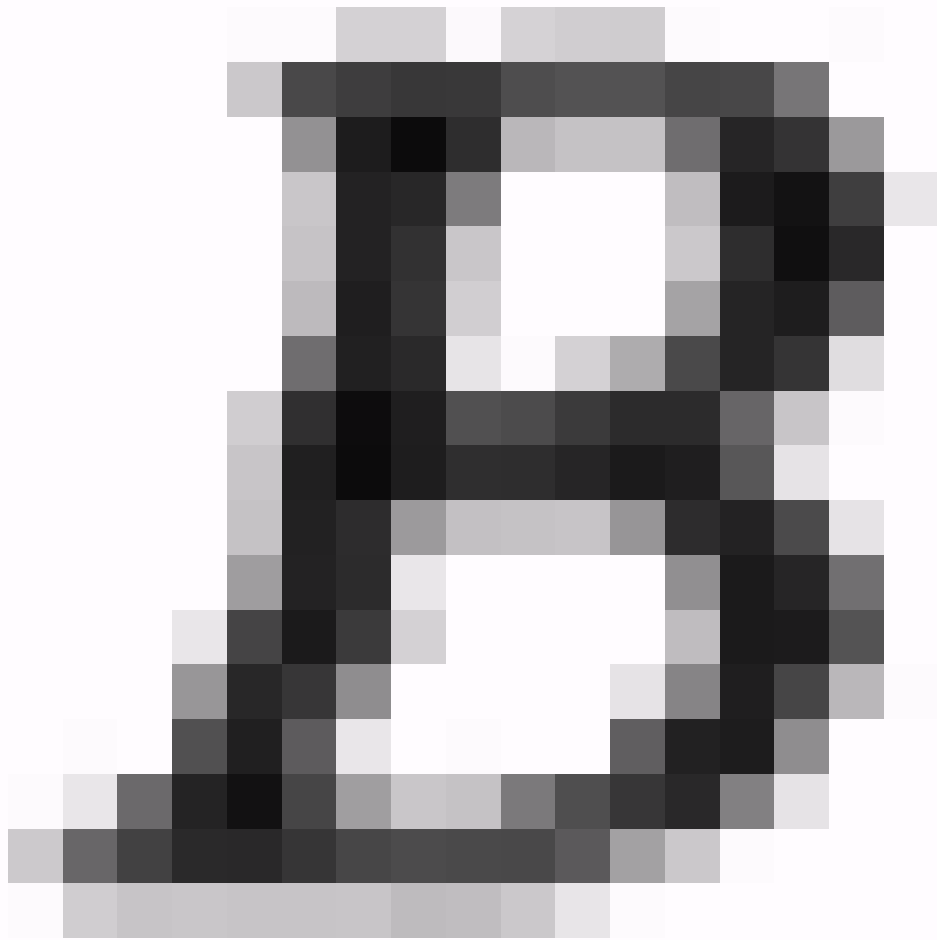

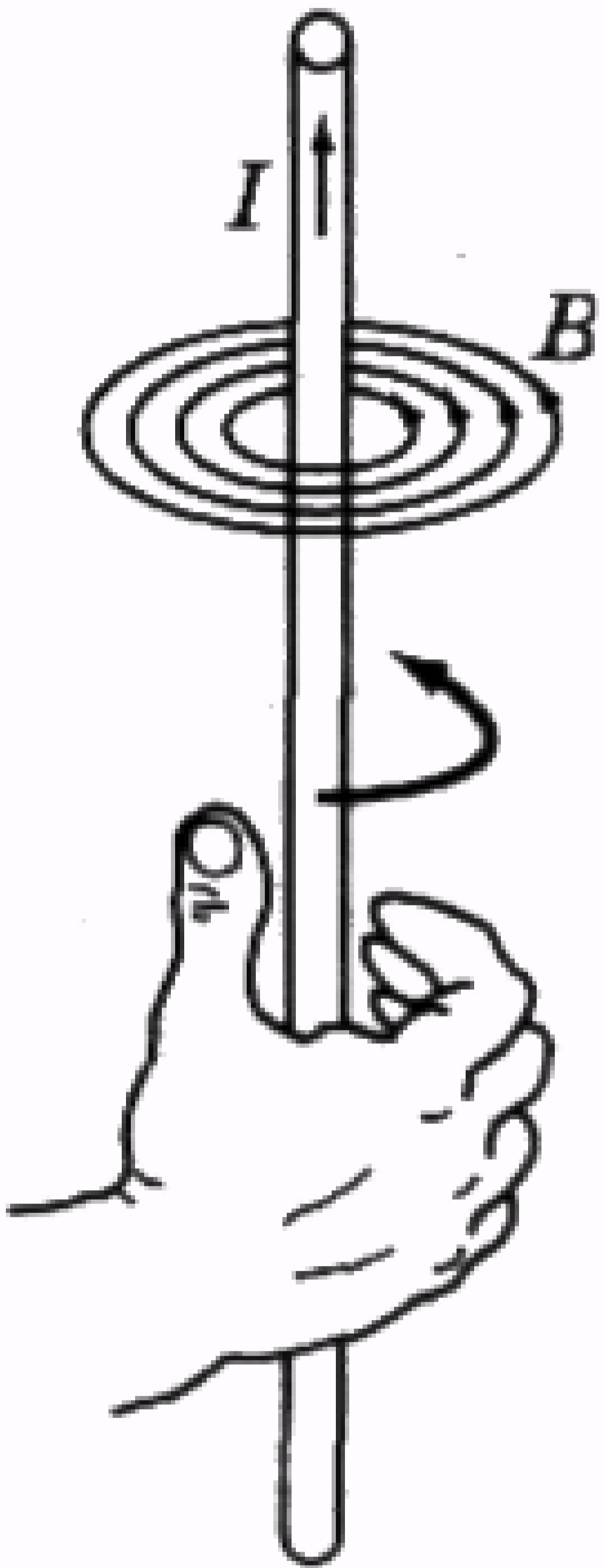

Mar. 2.142

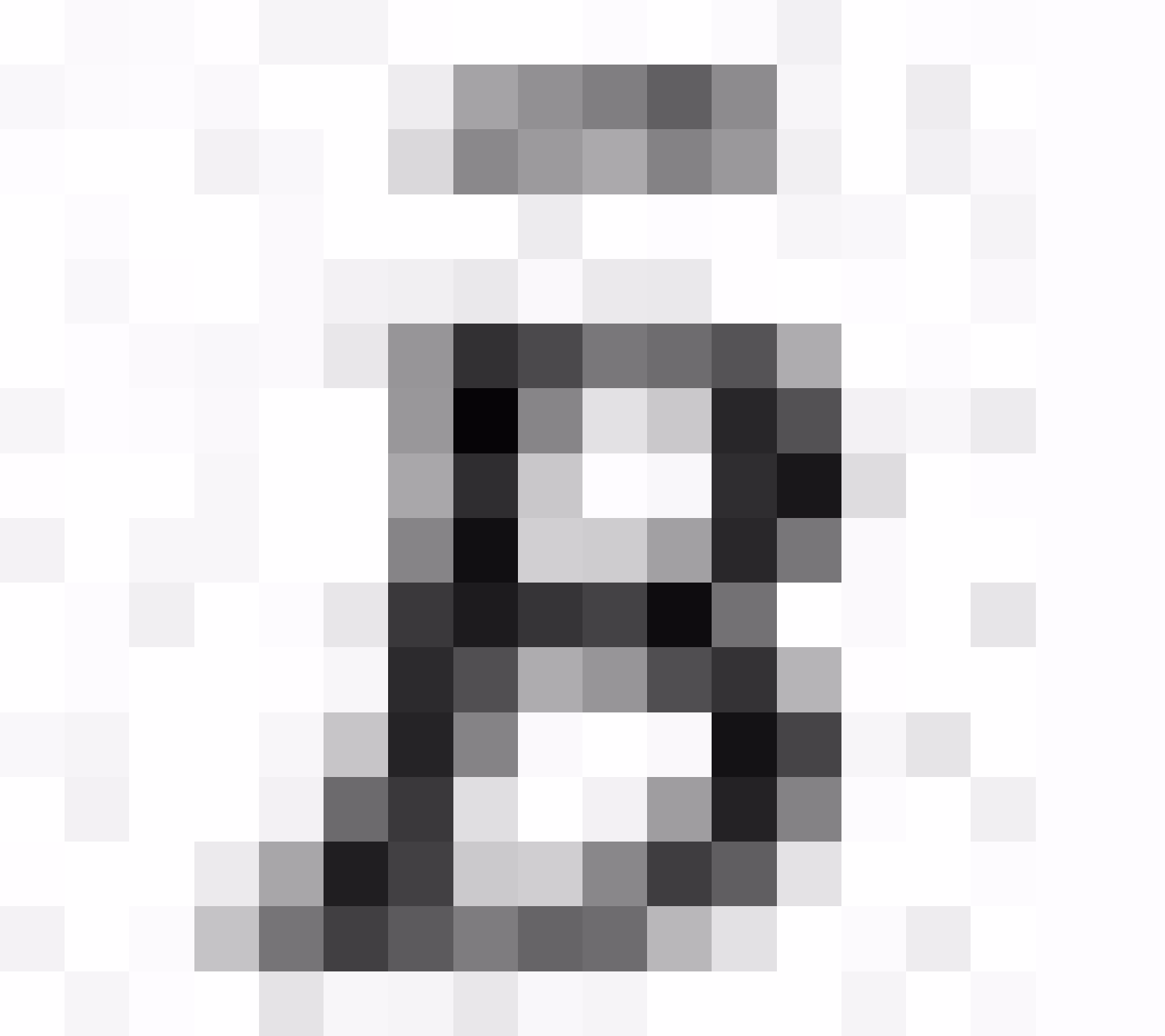

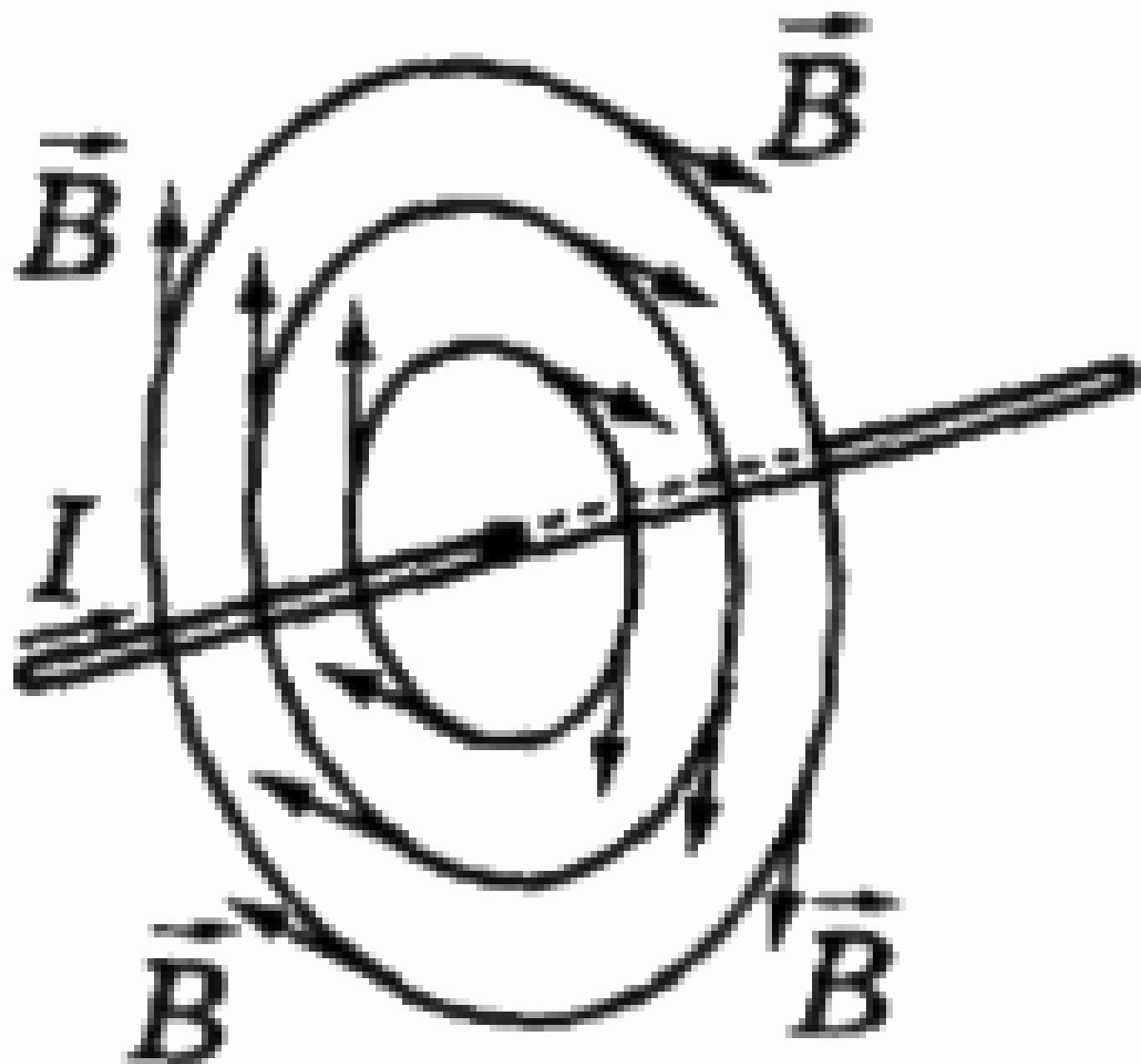

Мал. 2.141

$$B = R \cdot \frac{I}{R}$$

(43.2)

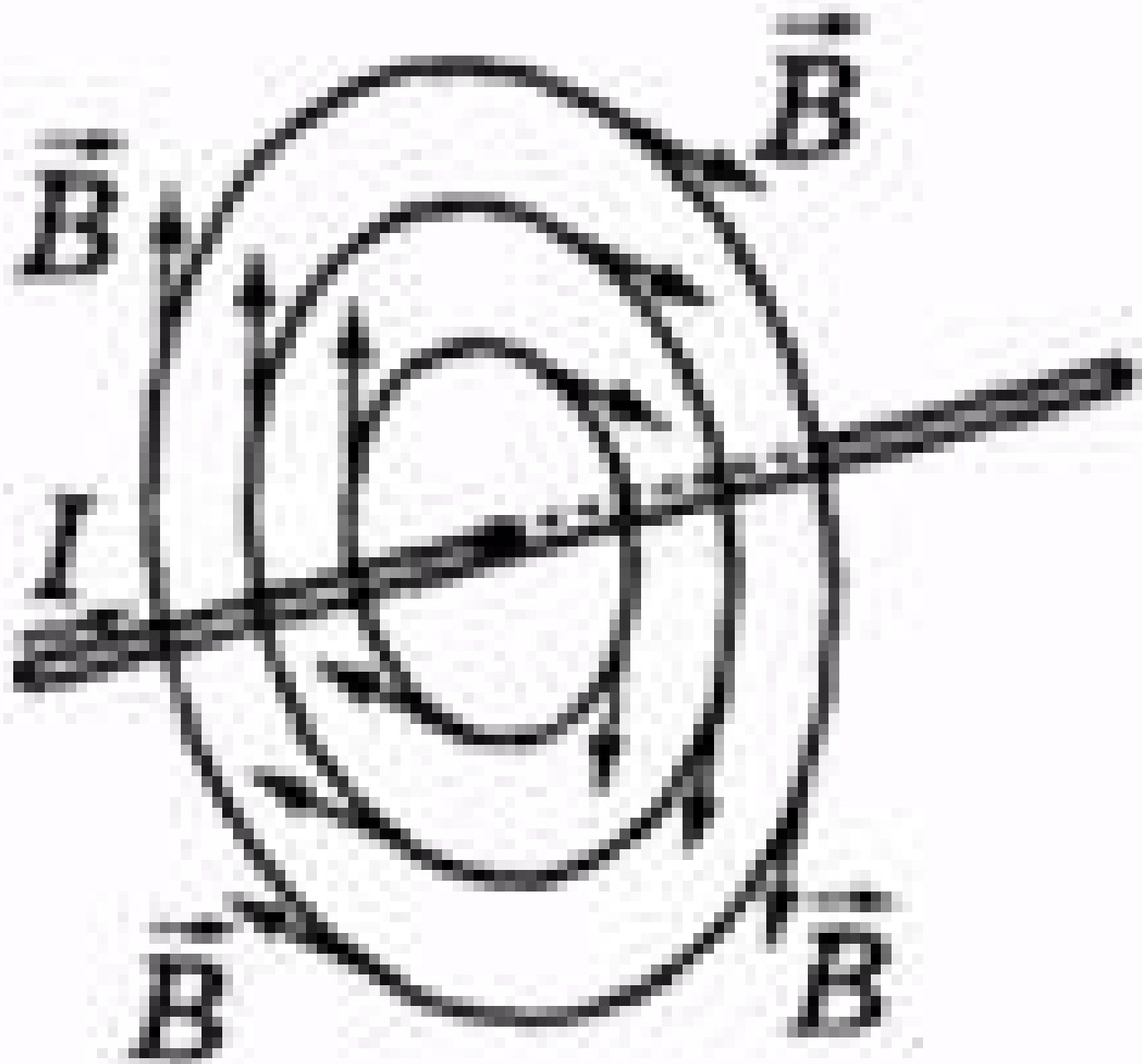

MOA. 2-141

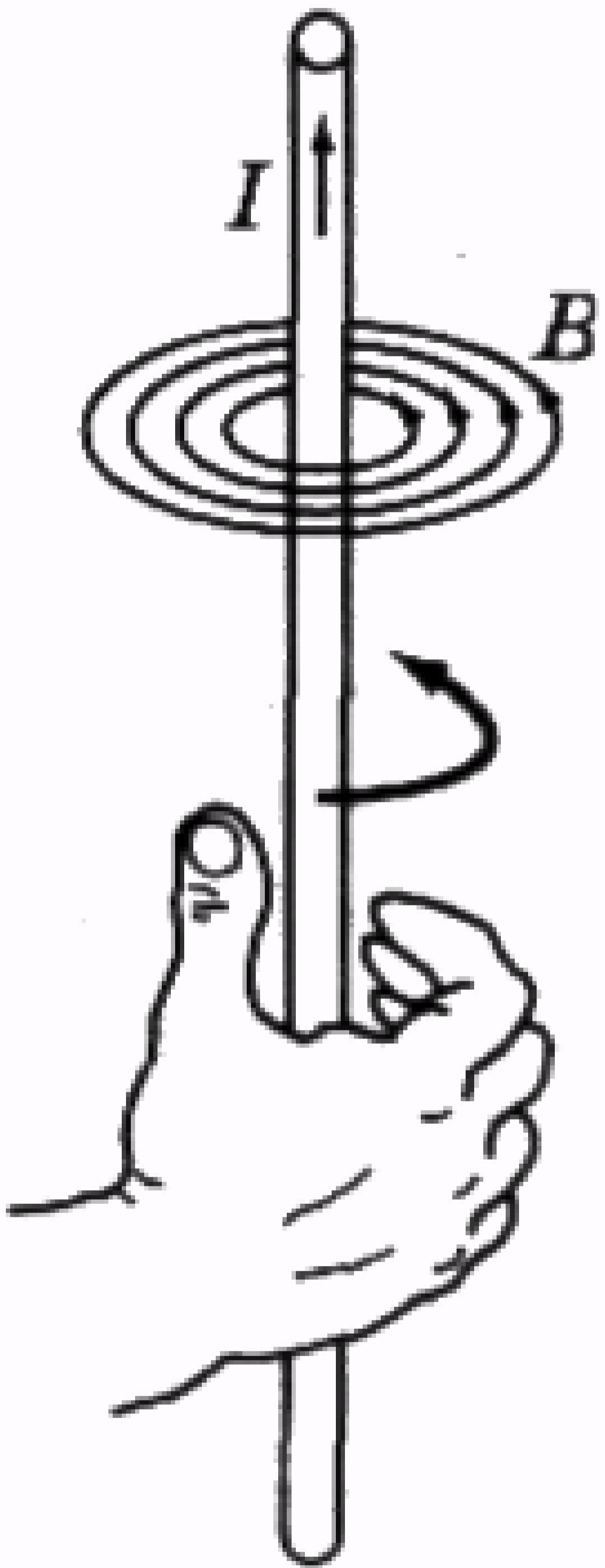

Mar. 2.142

DE

RE

=

2

1

0

1

RE

RE

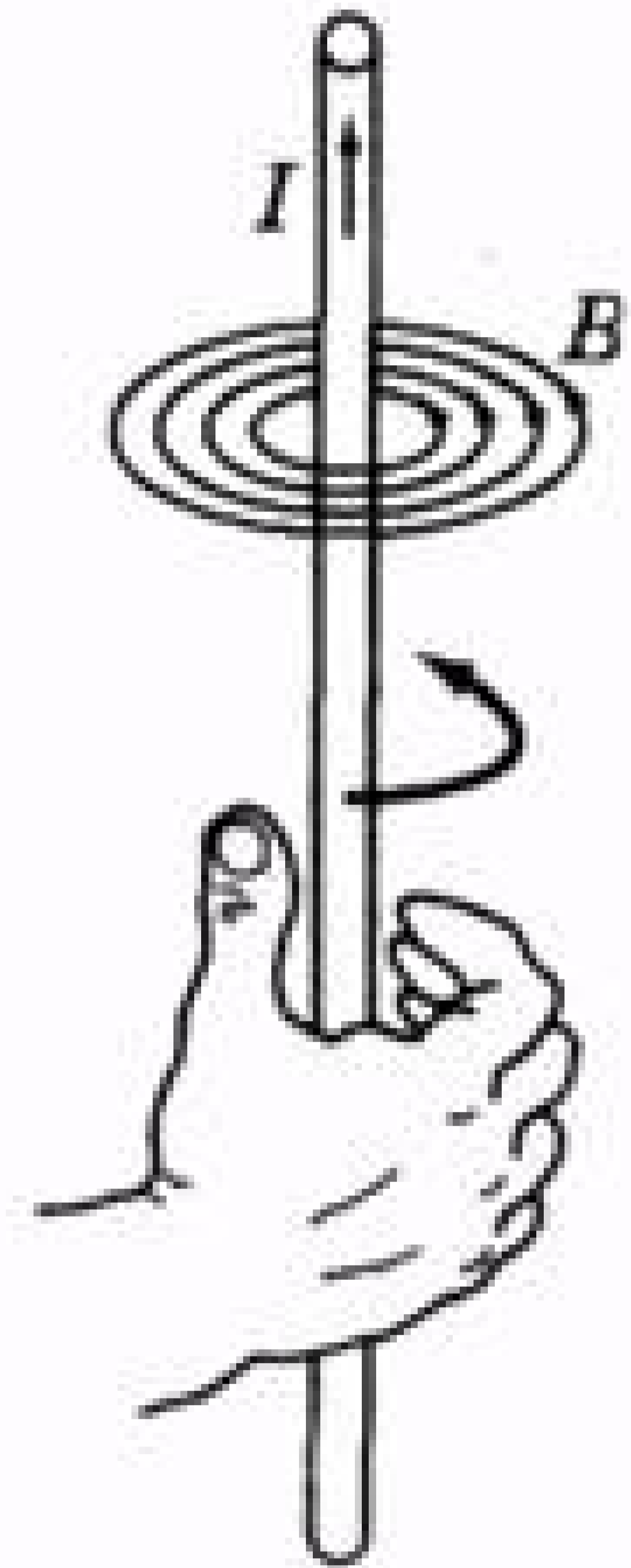

Mar. 2, 1912

$$B = R \cdot \frac{I}{R}$$

(43.2)

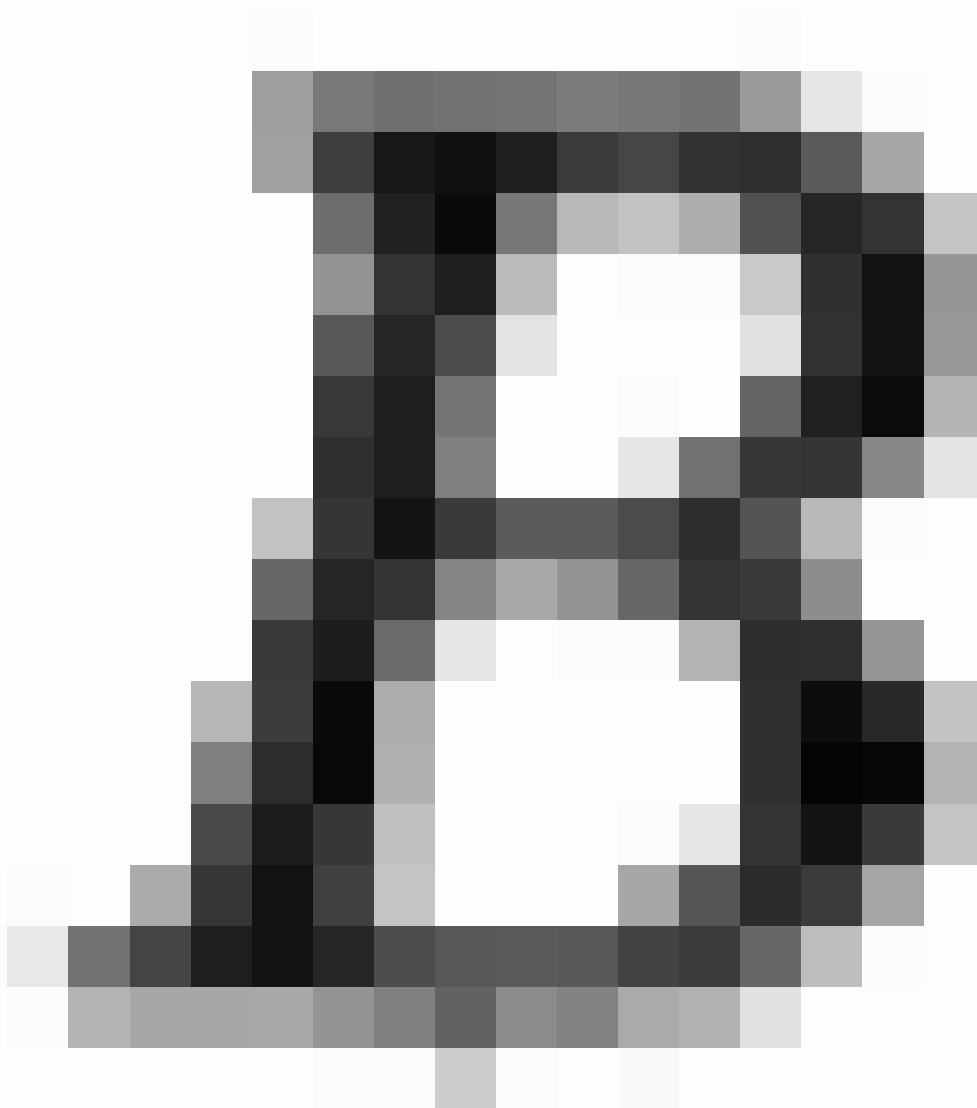
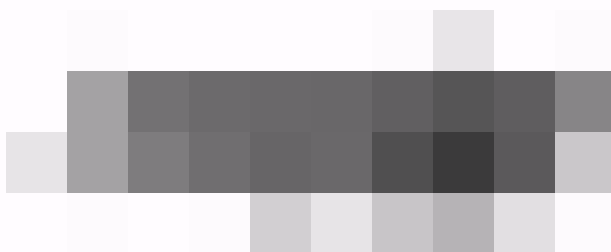
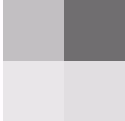

$\frac{1}{2} \times \frac{1}{2} = \frac{1}{4}$

$\frac{1}{2} \times \frac{3}{4} = \frac{3}{8}$

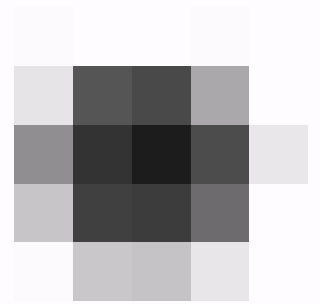
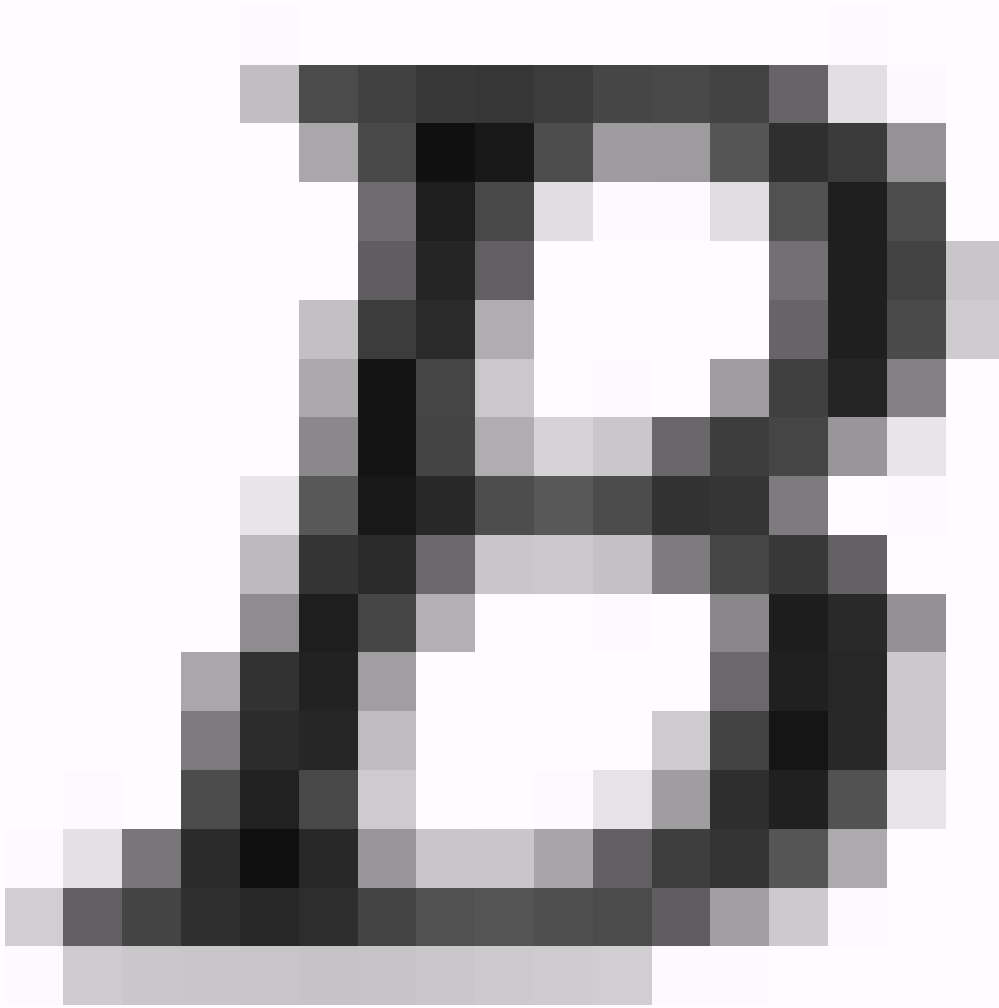
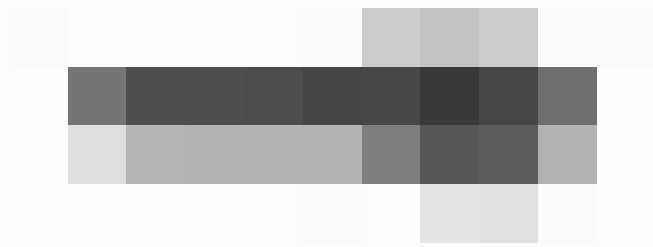

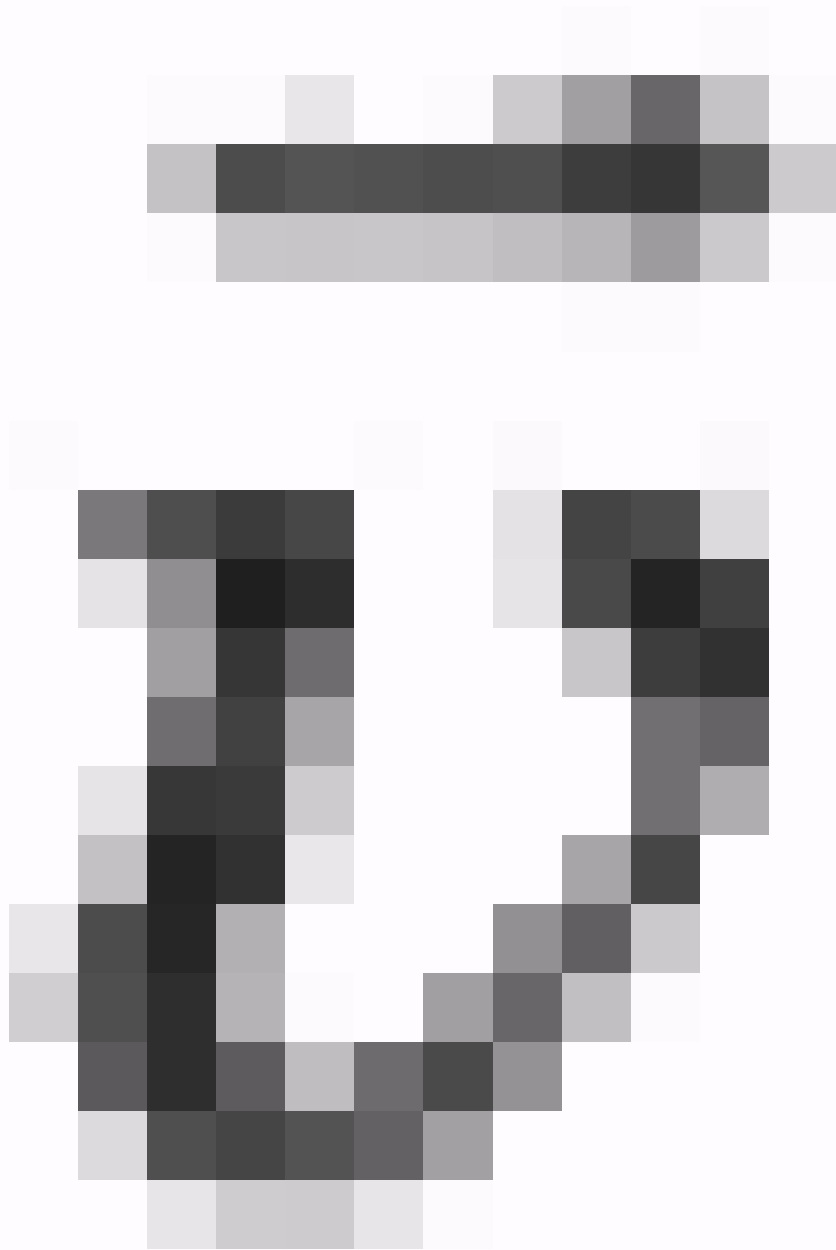

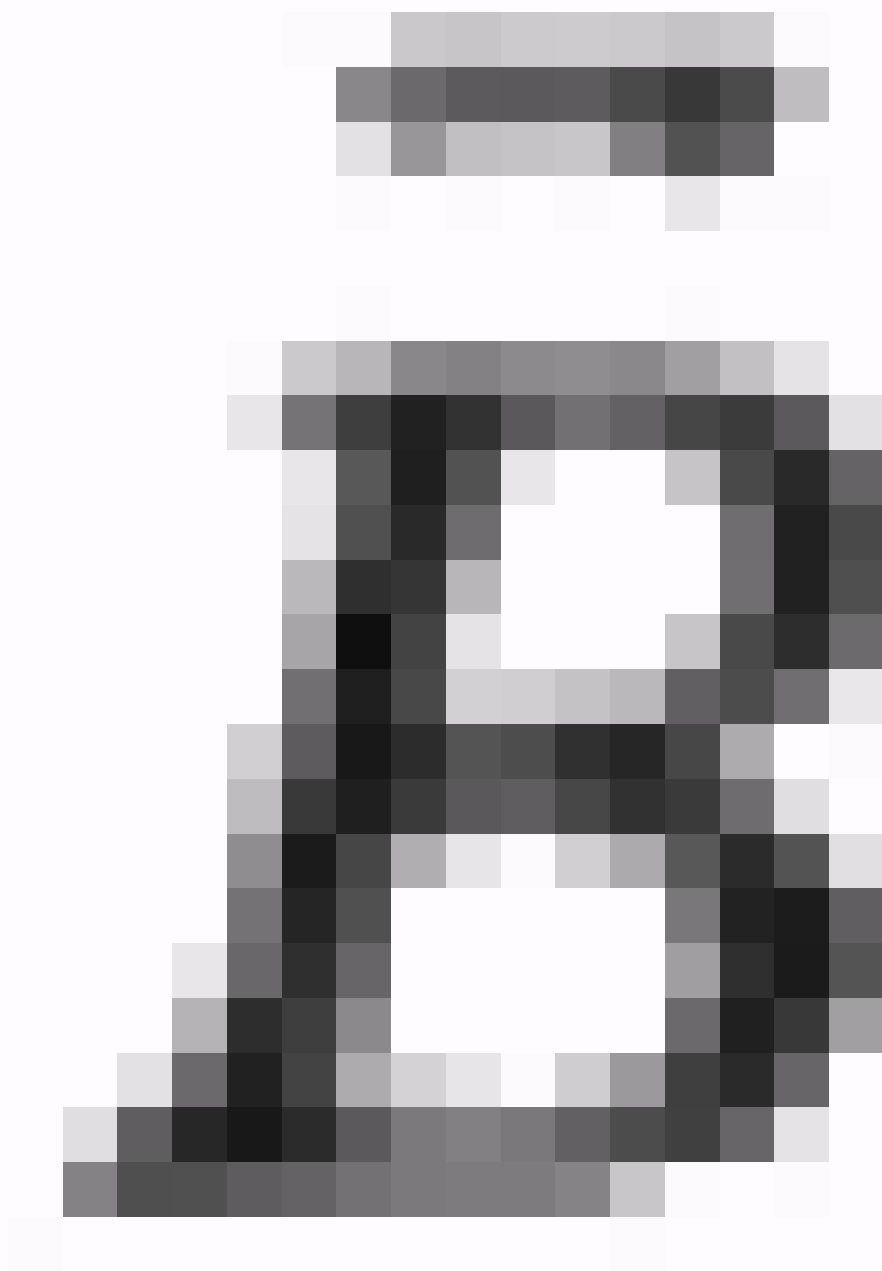

Q B

F =

Q B v

(43.4)

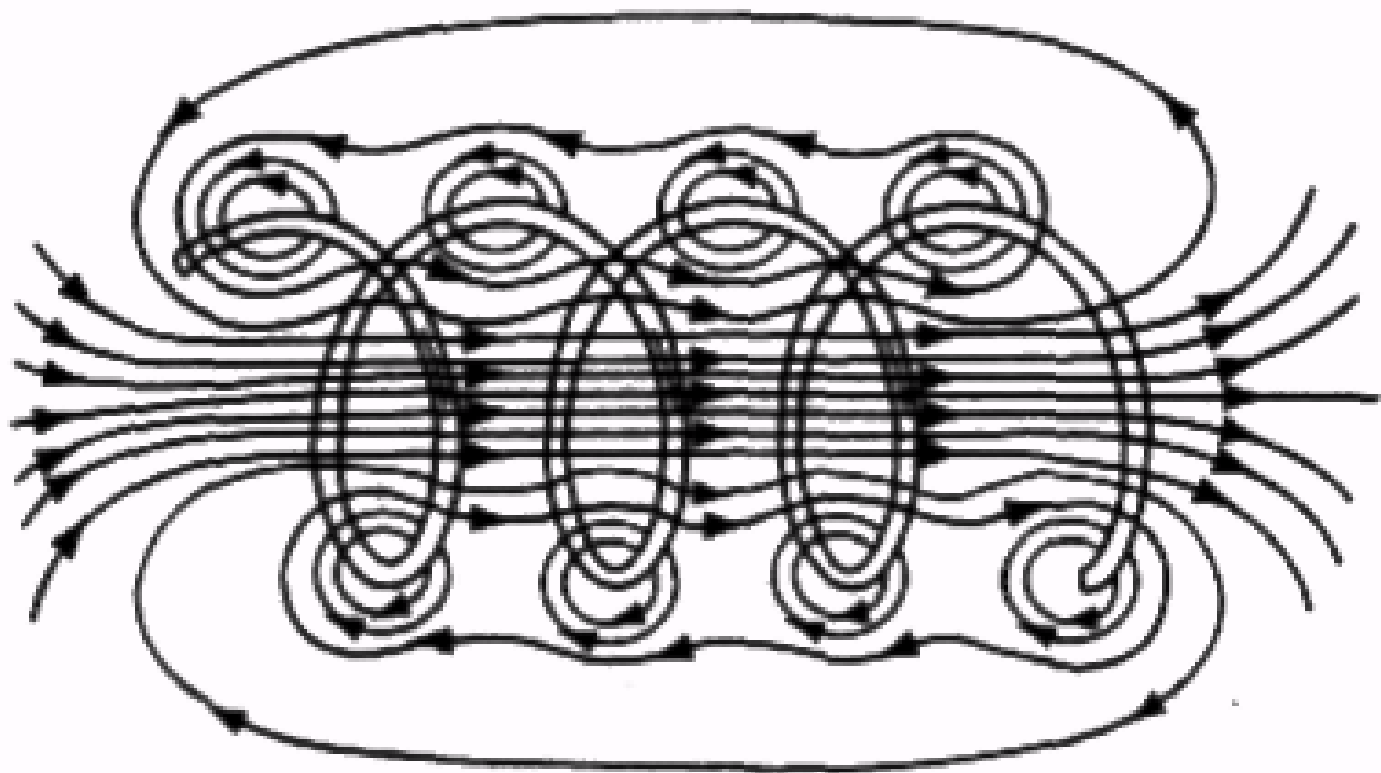

Мал. 2.143

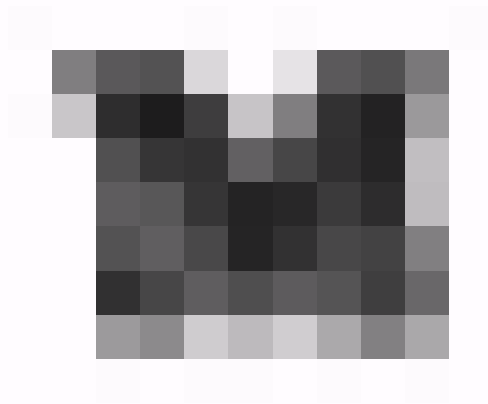
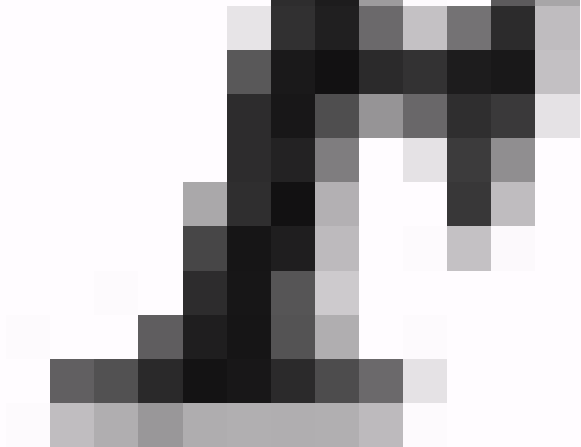
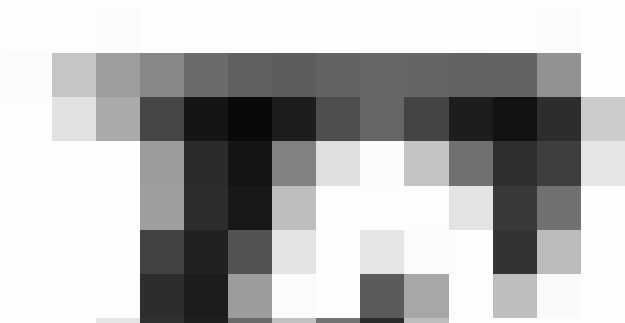
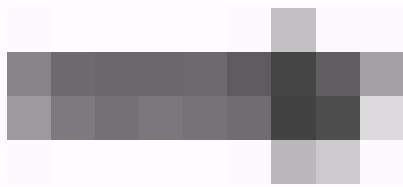

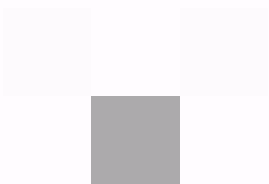
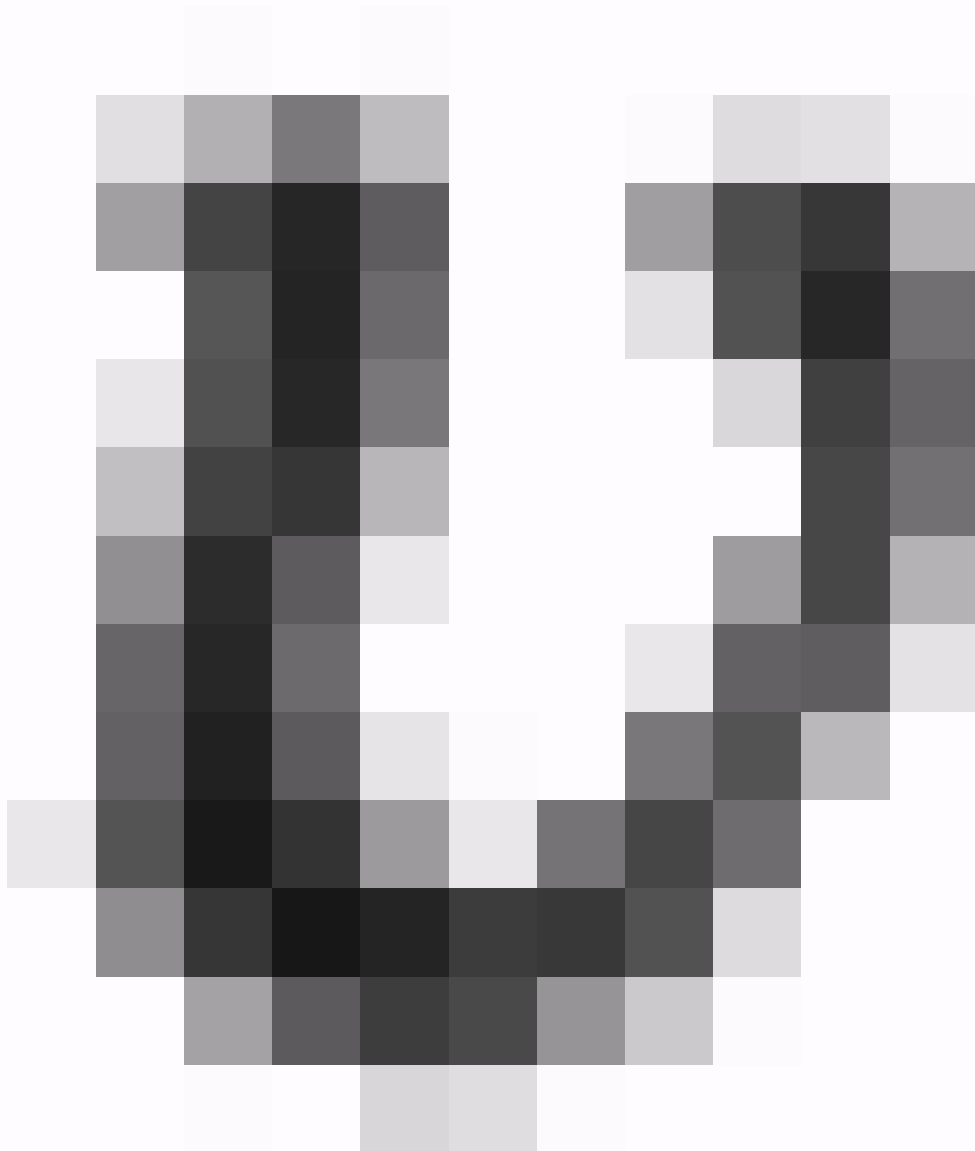

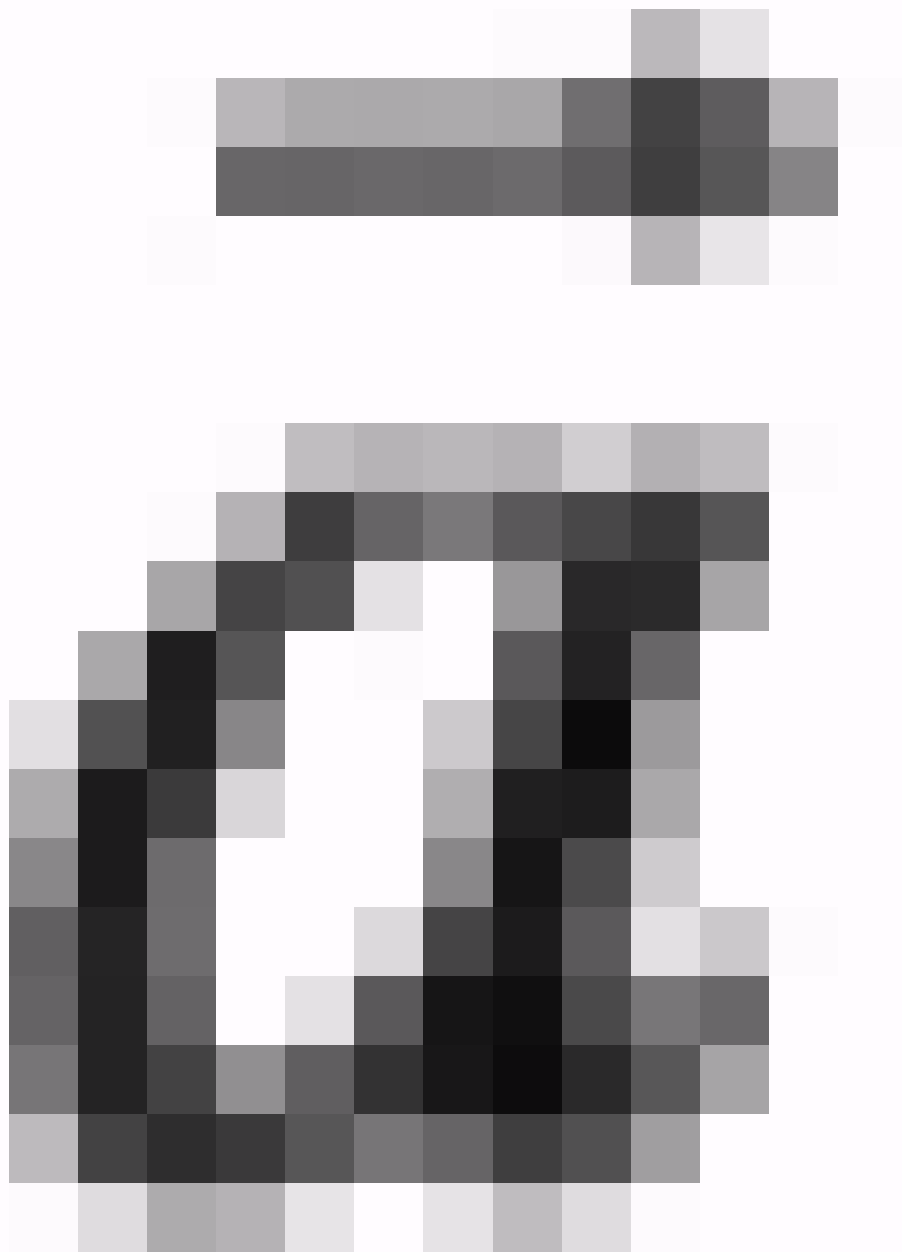

$$a = \frac{F}{m} = \frac{qBv}{m} \quad (43.5)$$



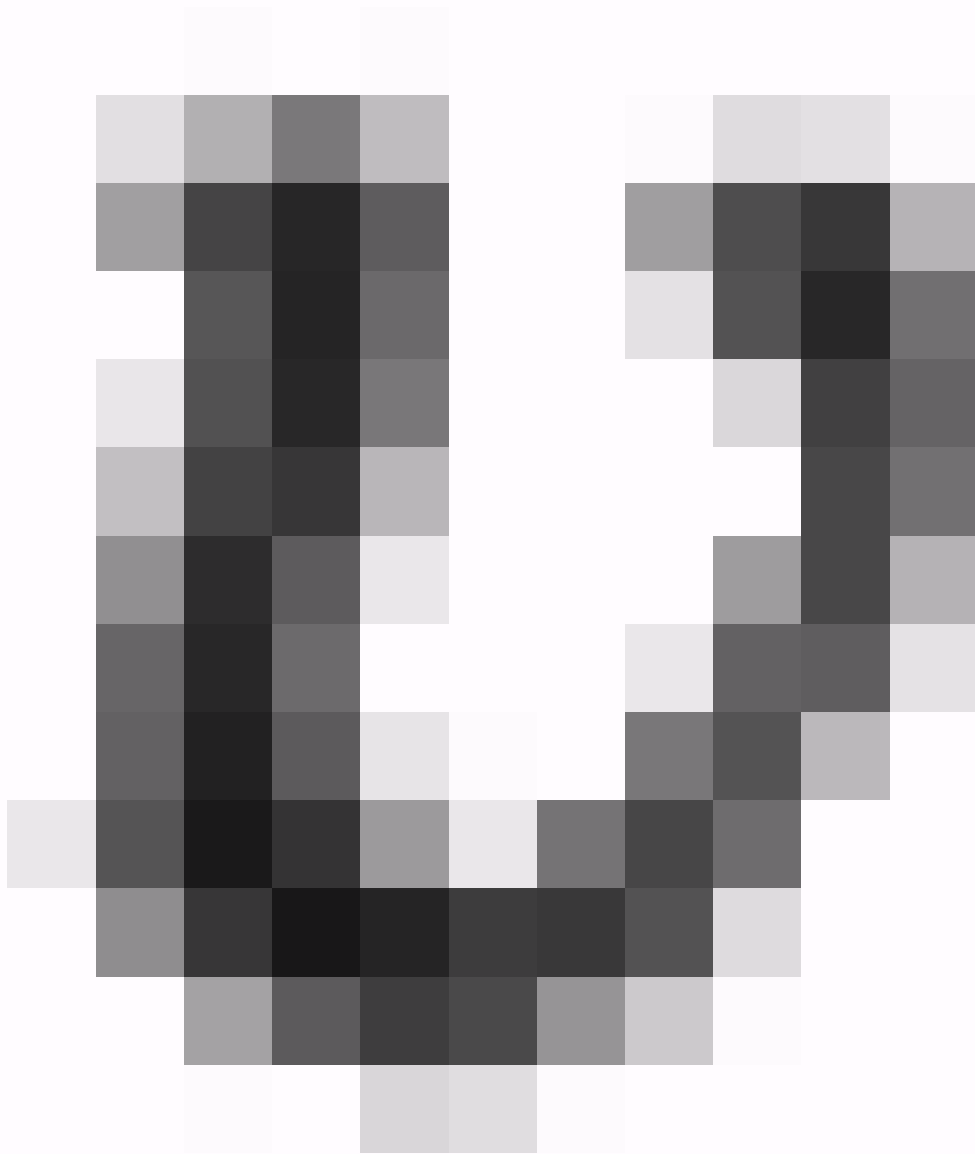
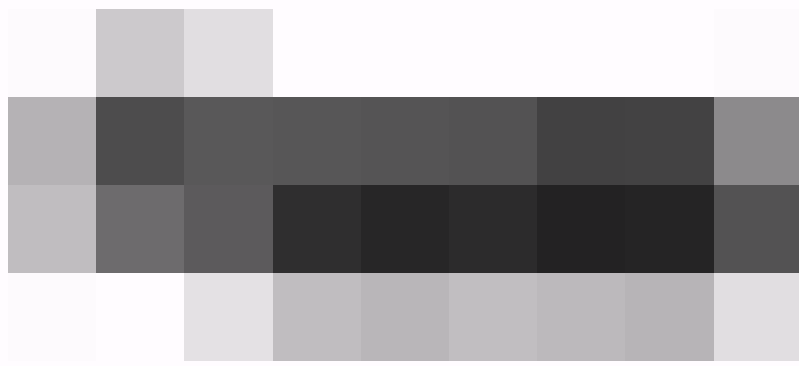

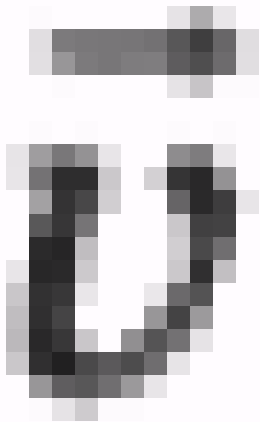
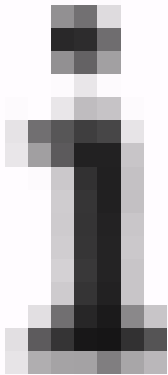
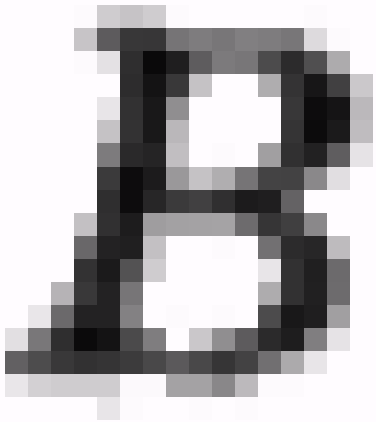

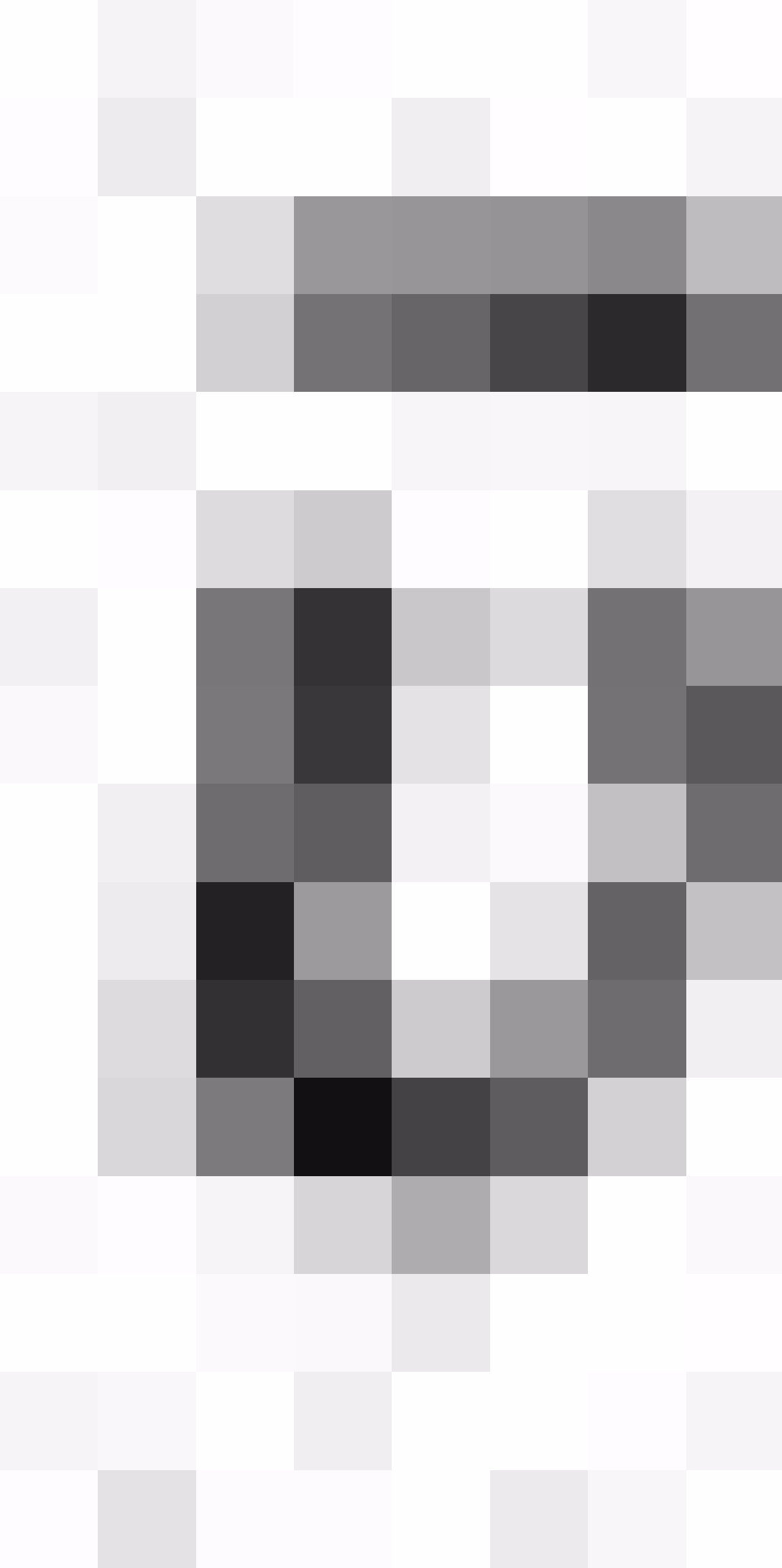

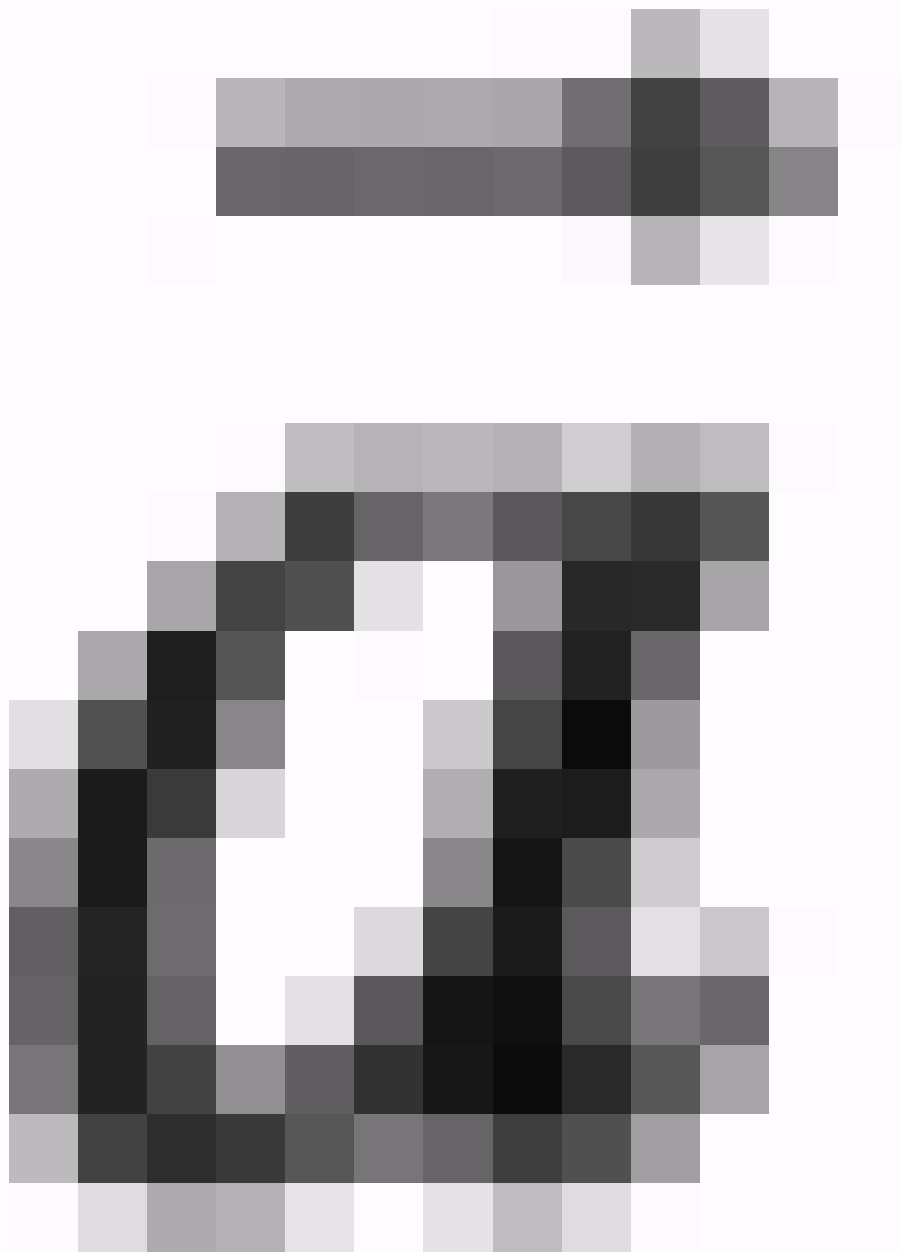

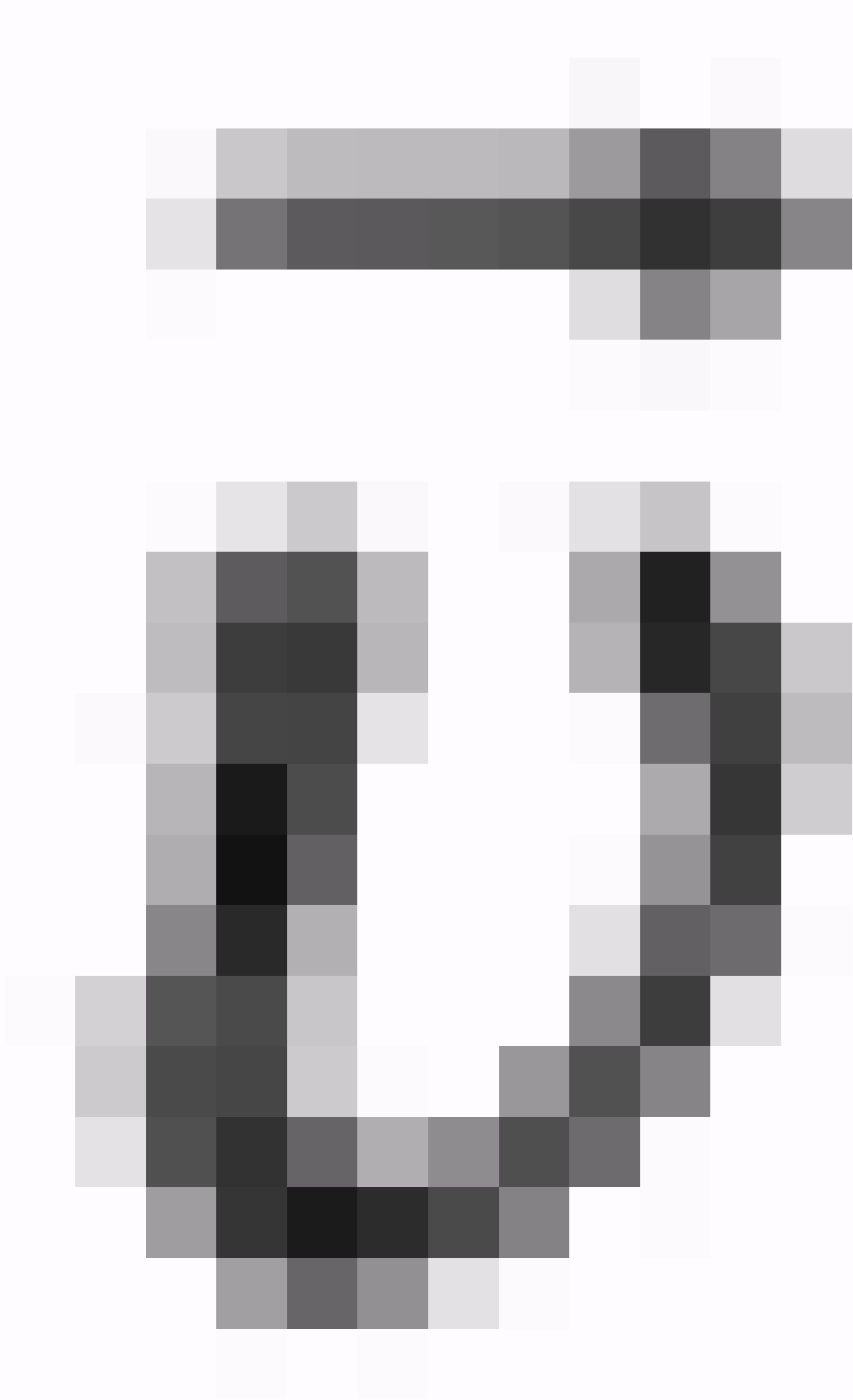

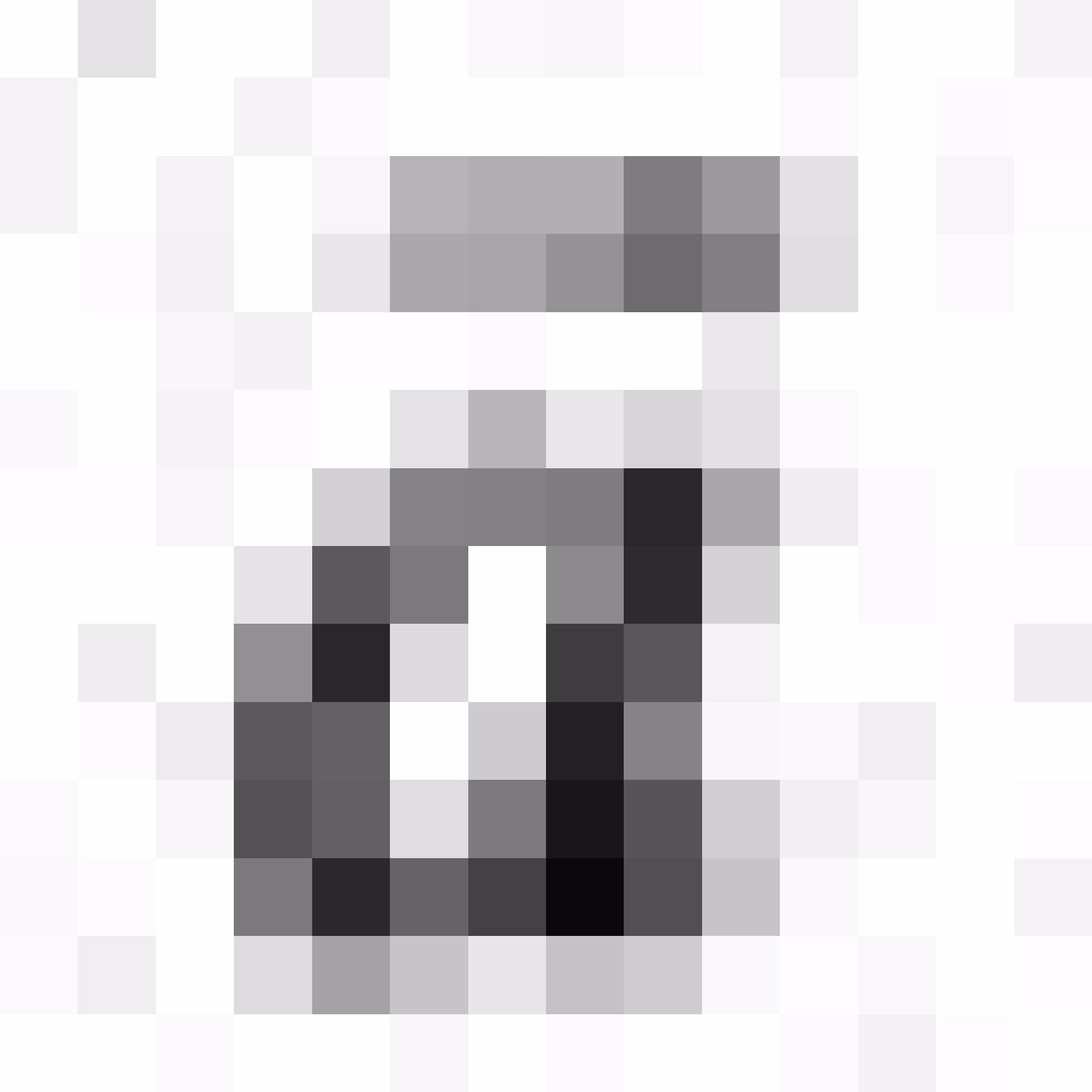

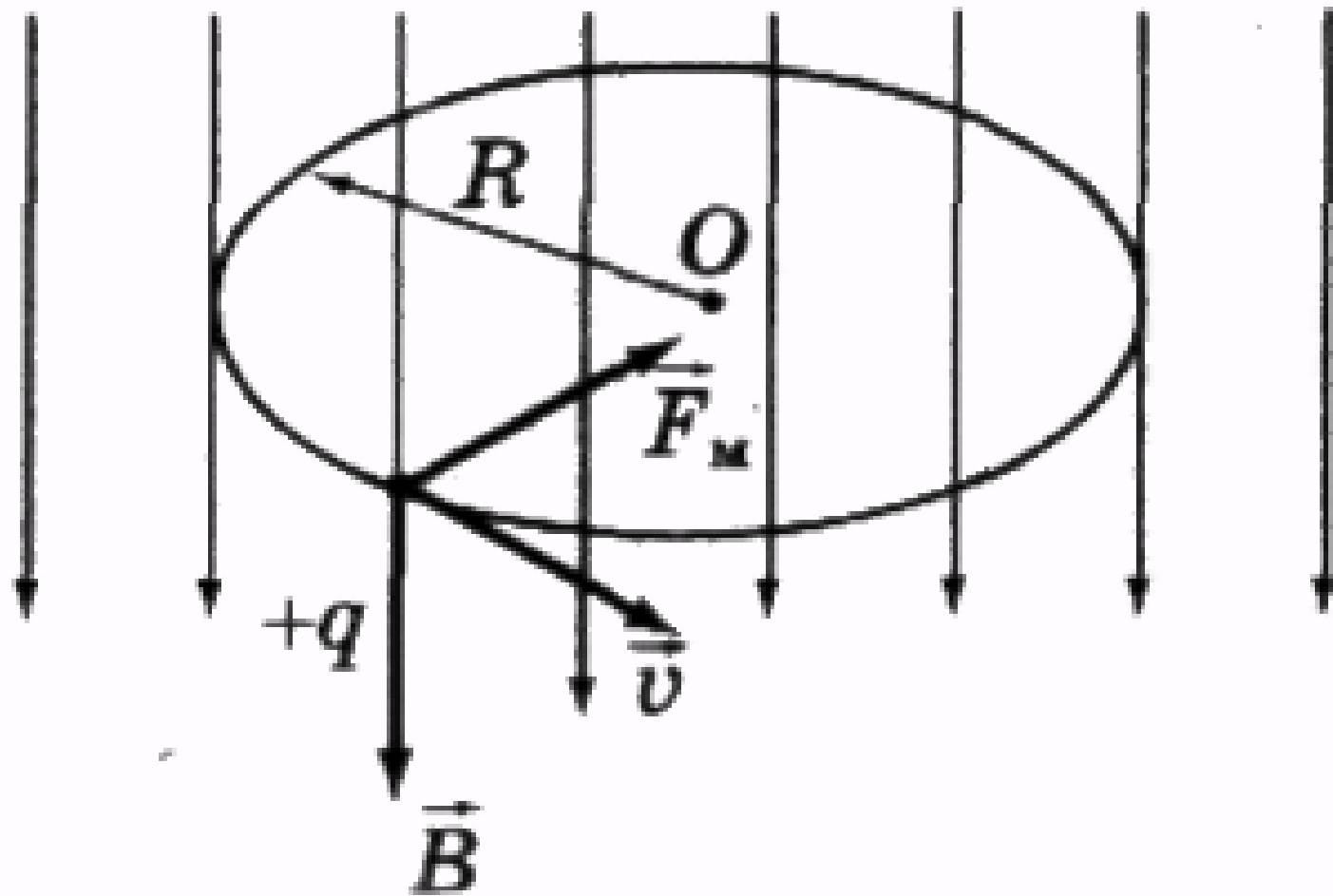

Мал. 2.144

$$a = \frac{v^2}{R} = \frac{qBv}{m} ,$$

$$R = \frac{mV}{qB} \quad (43.6)$$

$$T = \frac{2\pi R}{v} = \frac{2\pi Mv}{vqB} = \frac{2\pi M}{qB} \quad (43.7)$$

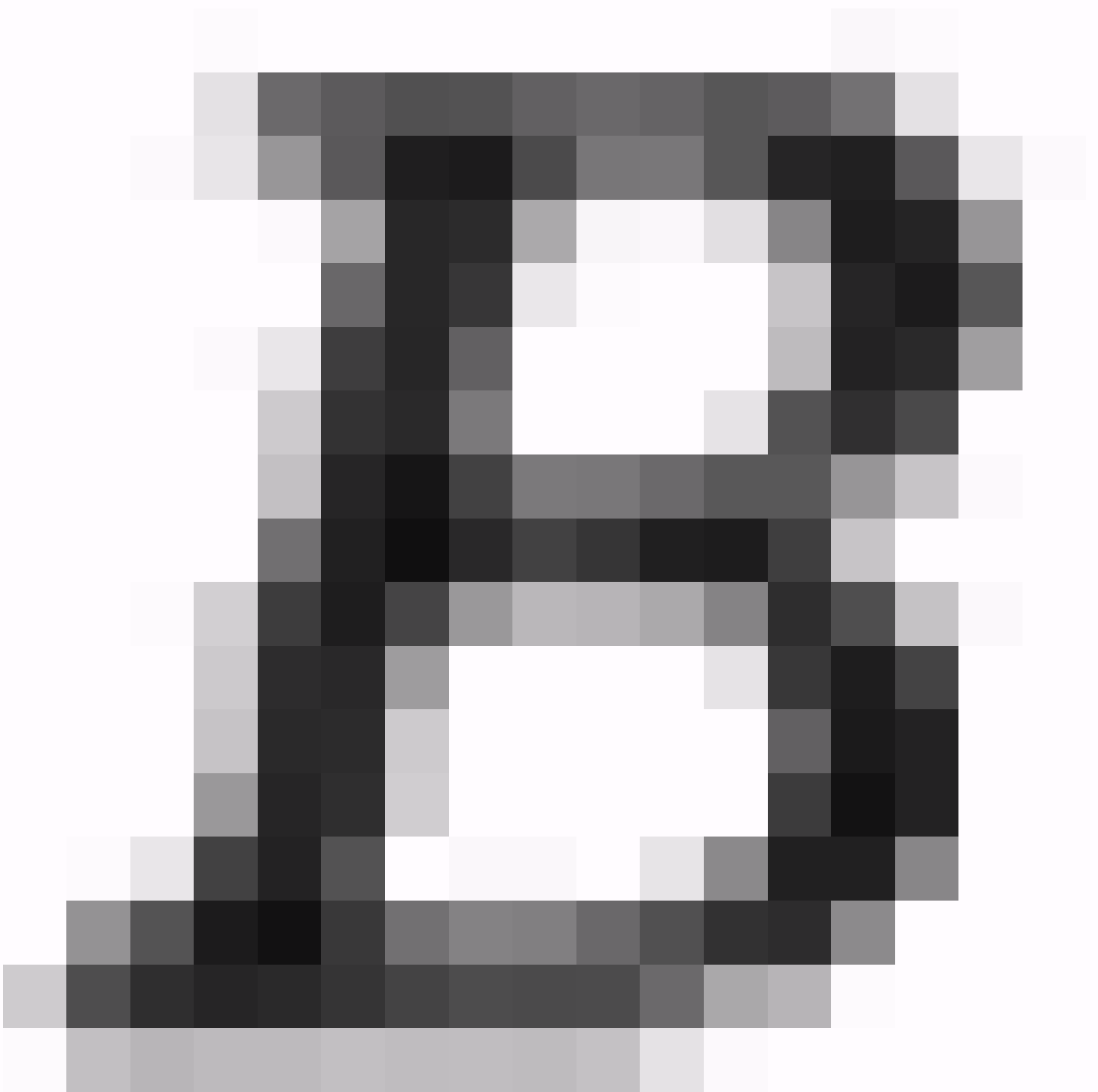
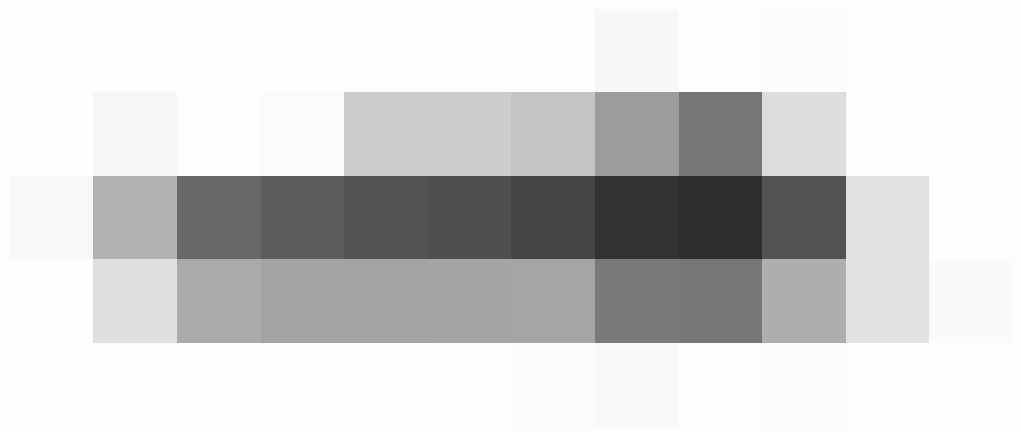

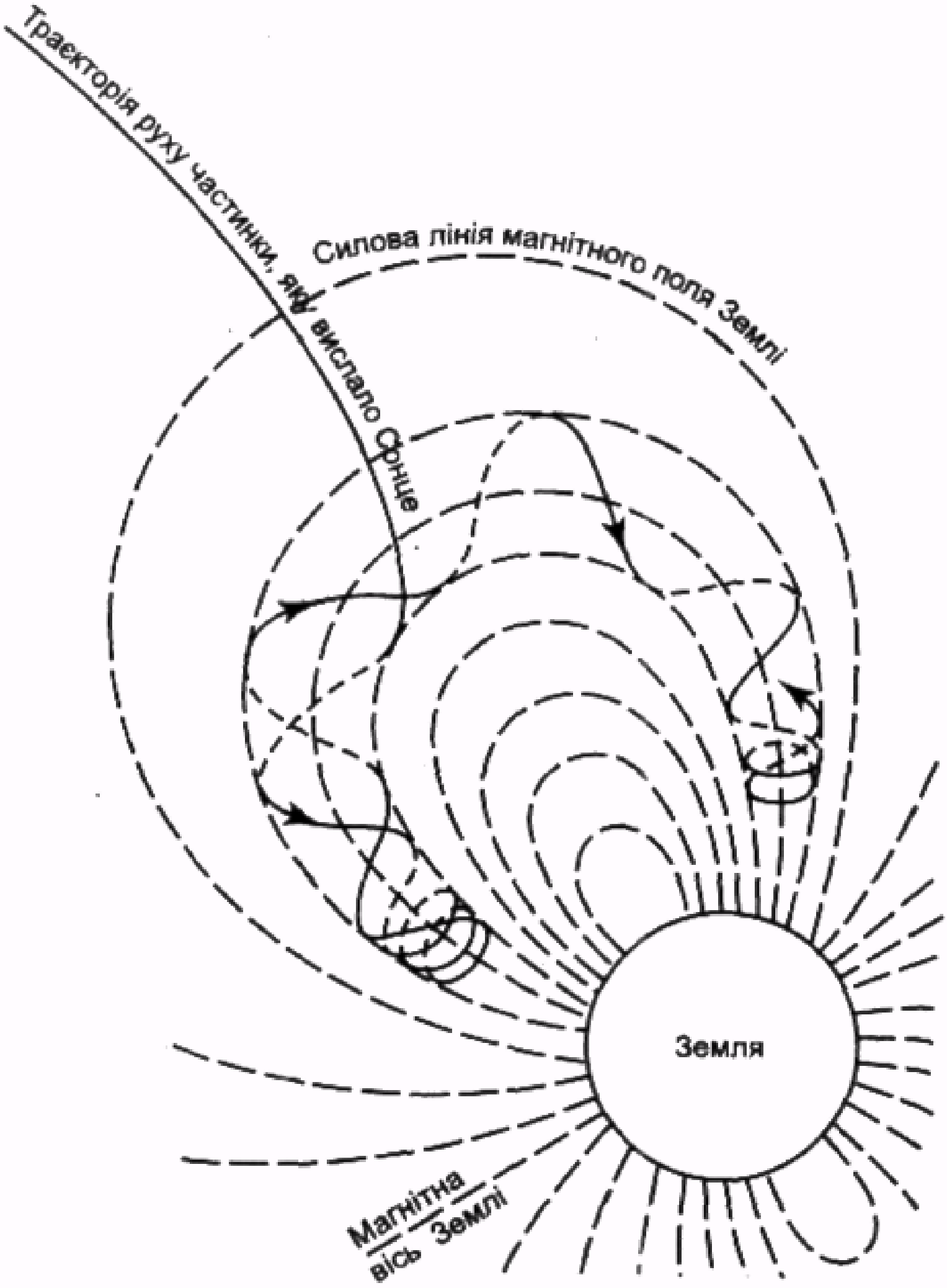

Мал. 2.145





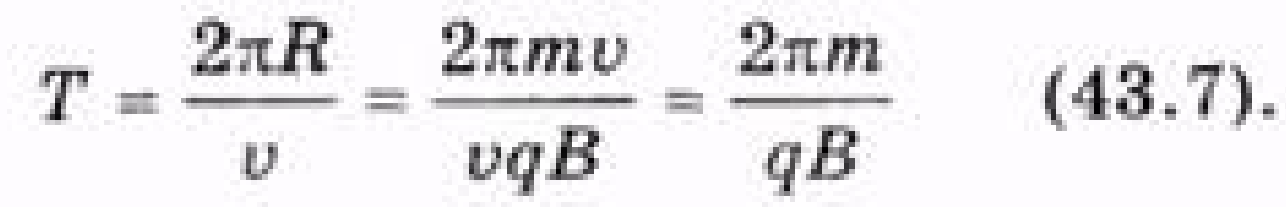



13.11.2019

$\frac{1}{2} = \frac{1}{2} + \frac{1}{2}$

(43.8)

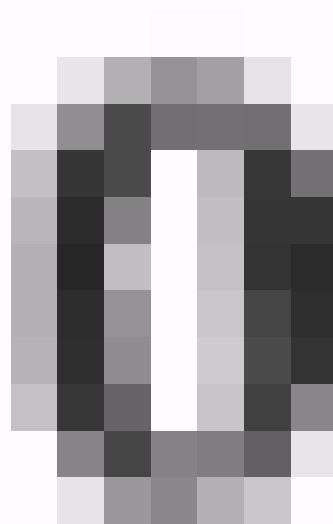
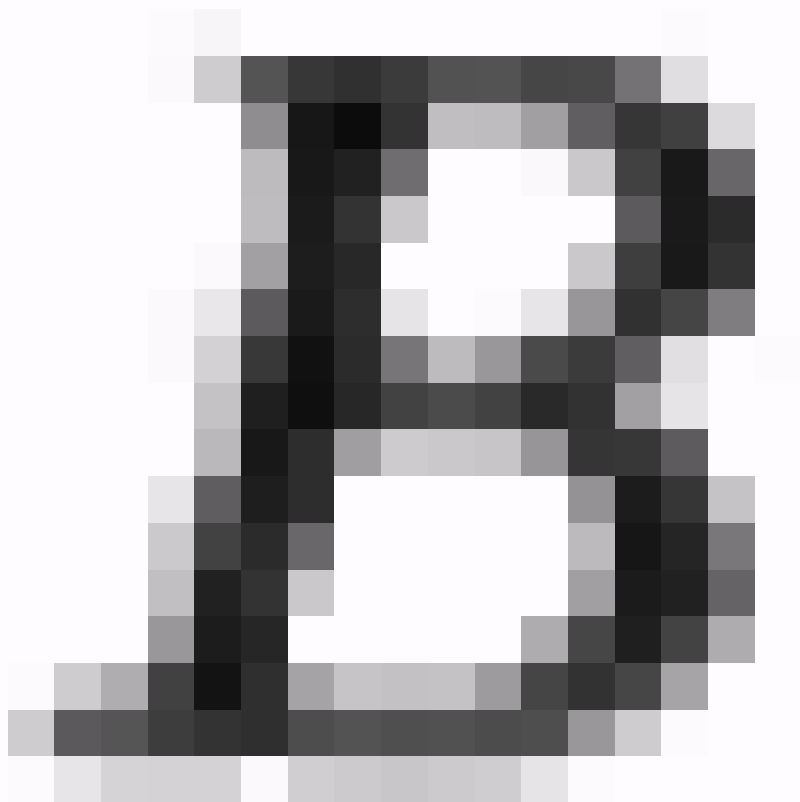



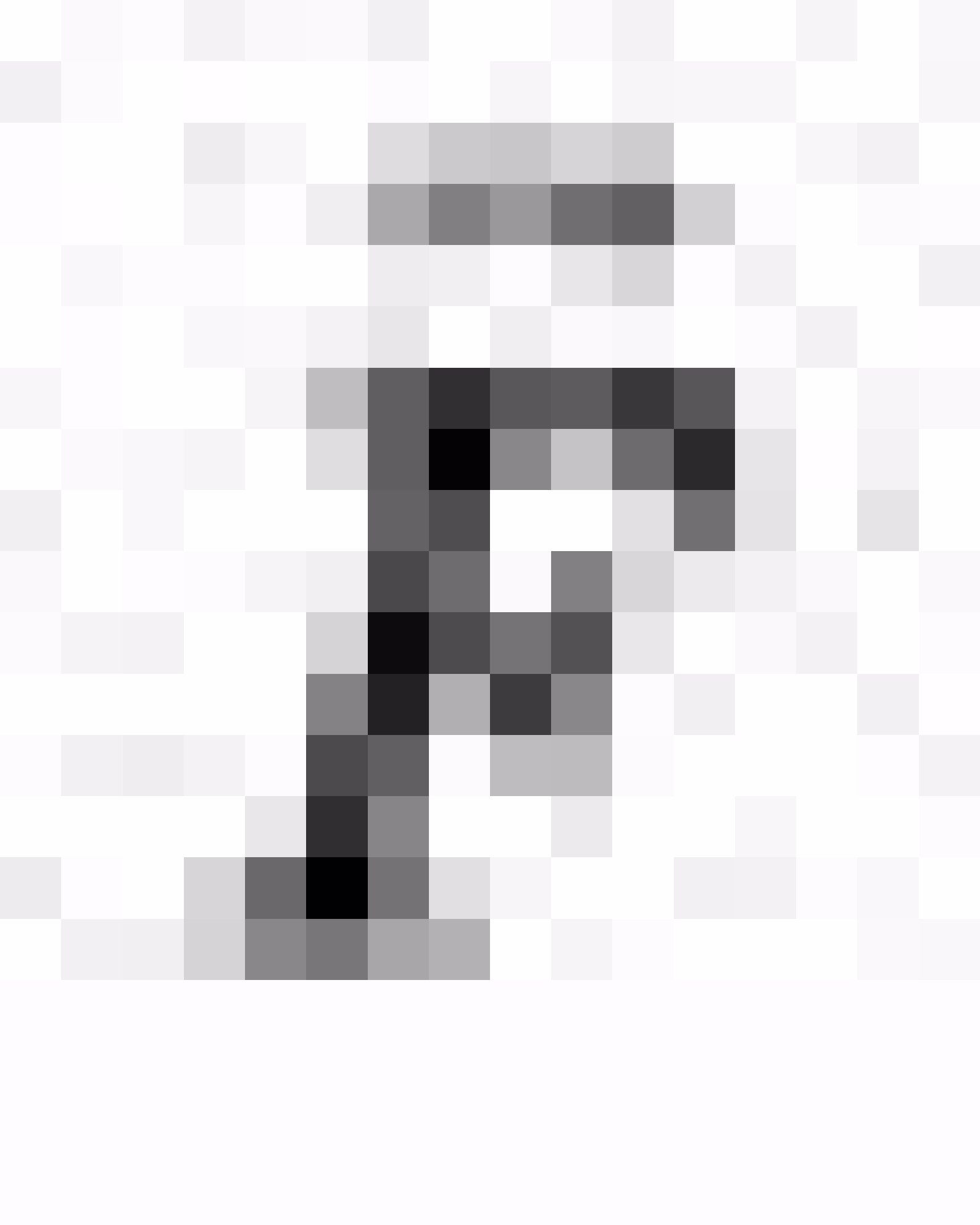

4

=

—

•

B
O

B

11

=

0

.

0

0

0

0

0

1

.

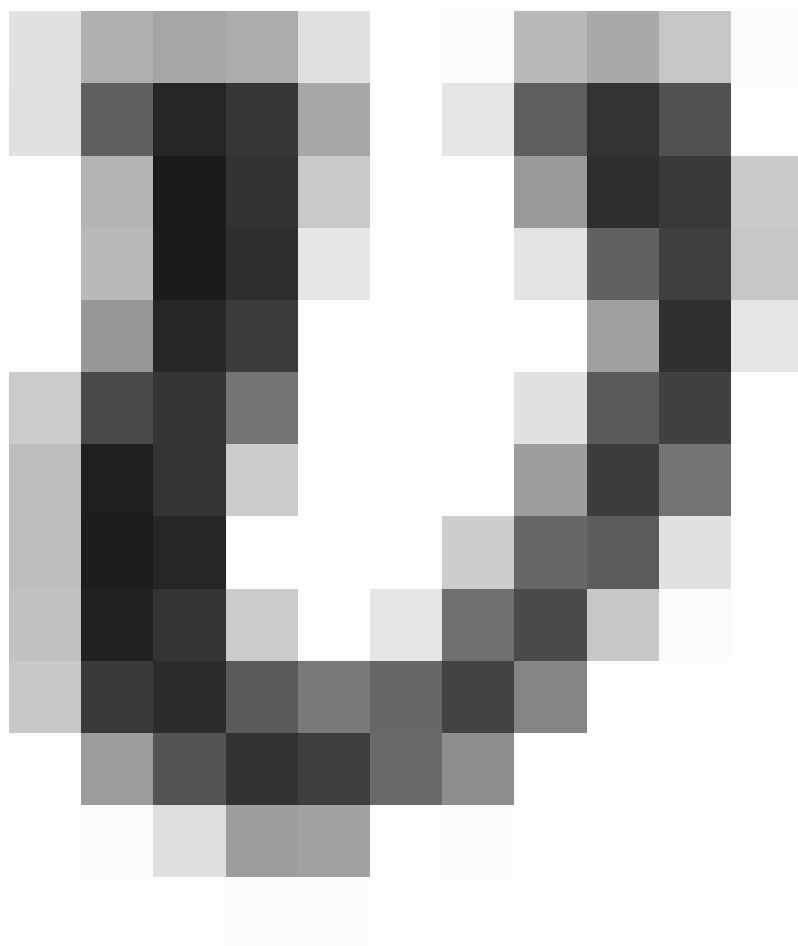

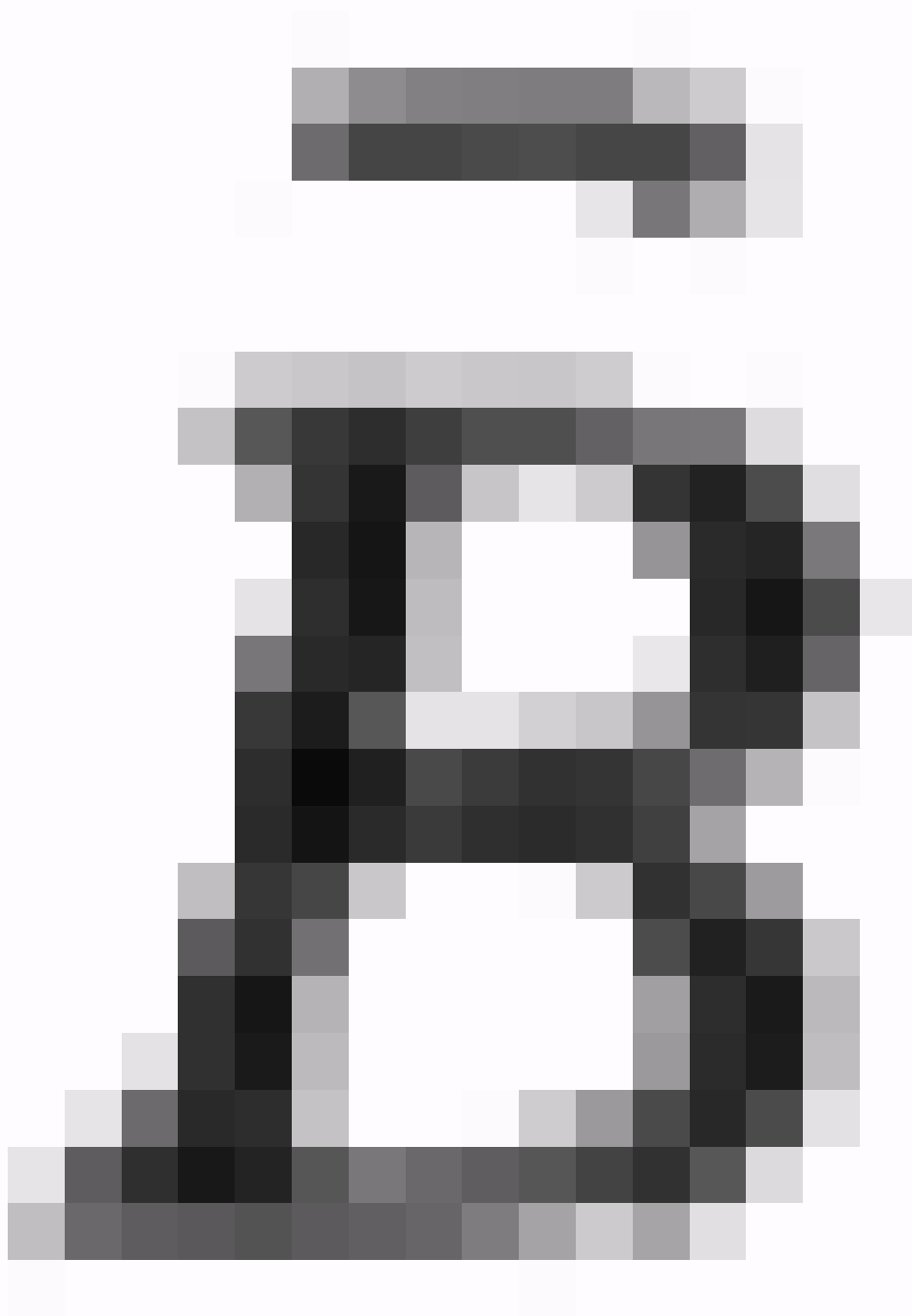



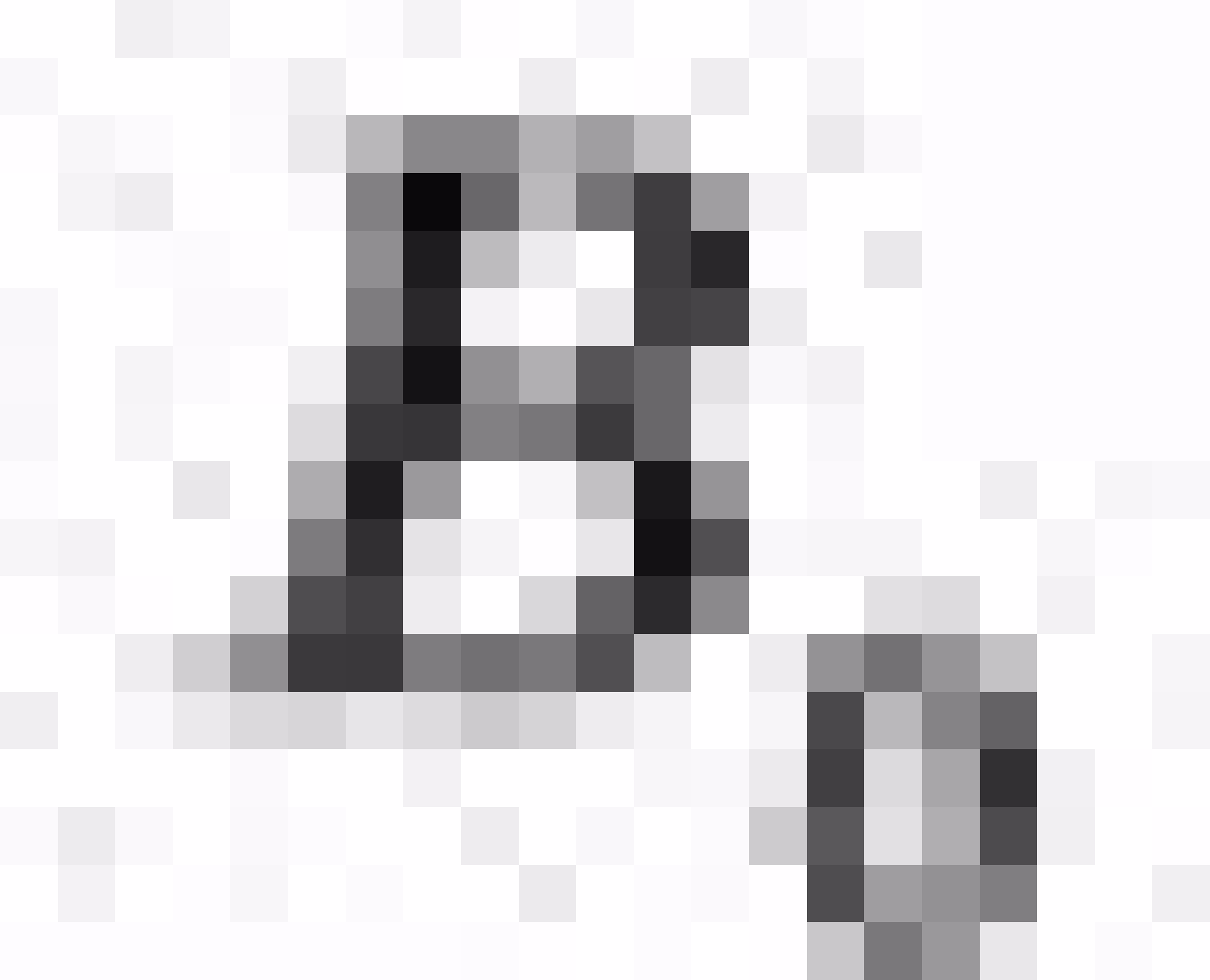

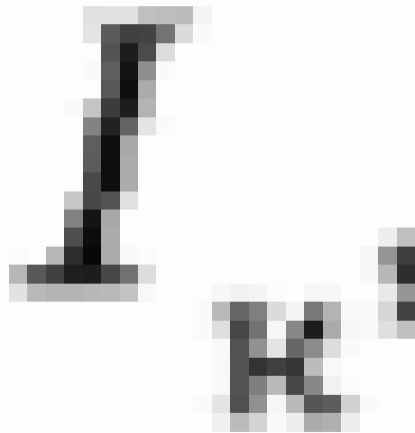
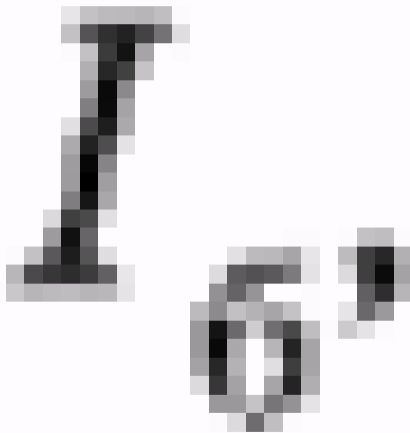
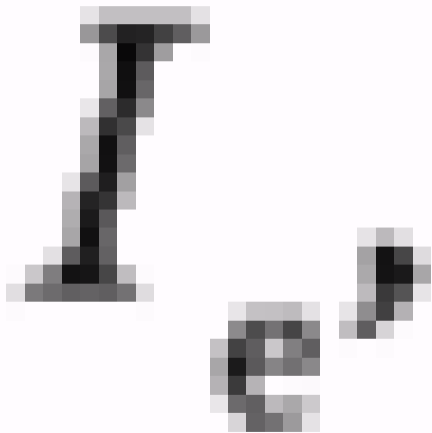



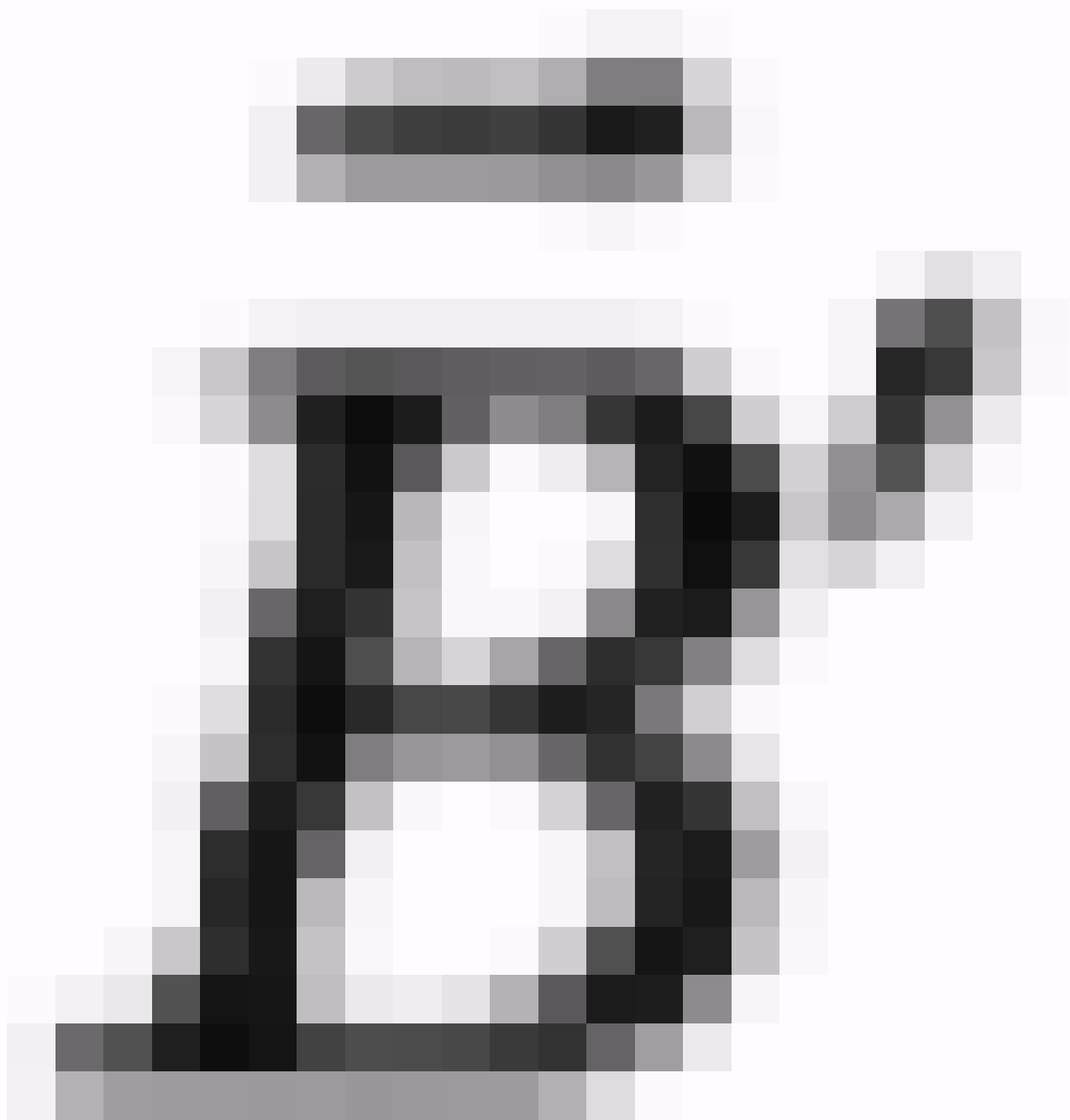

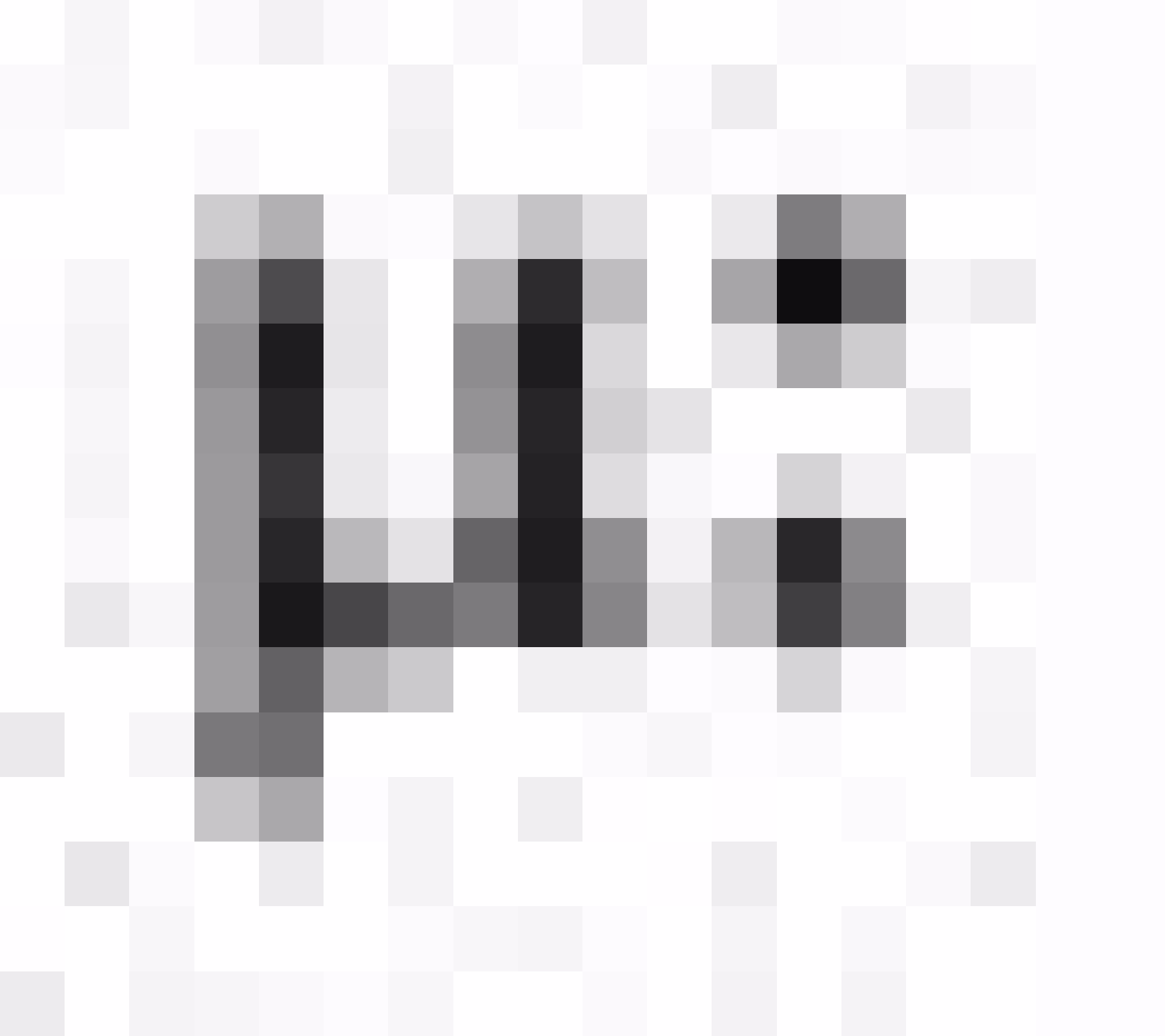



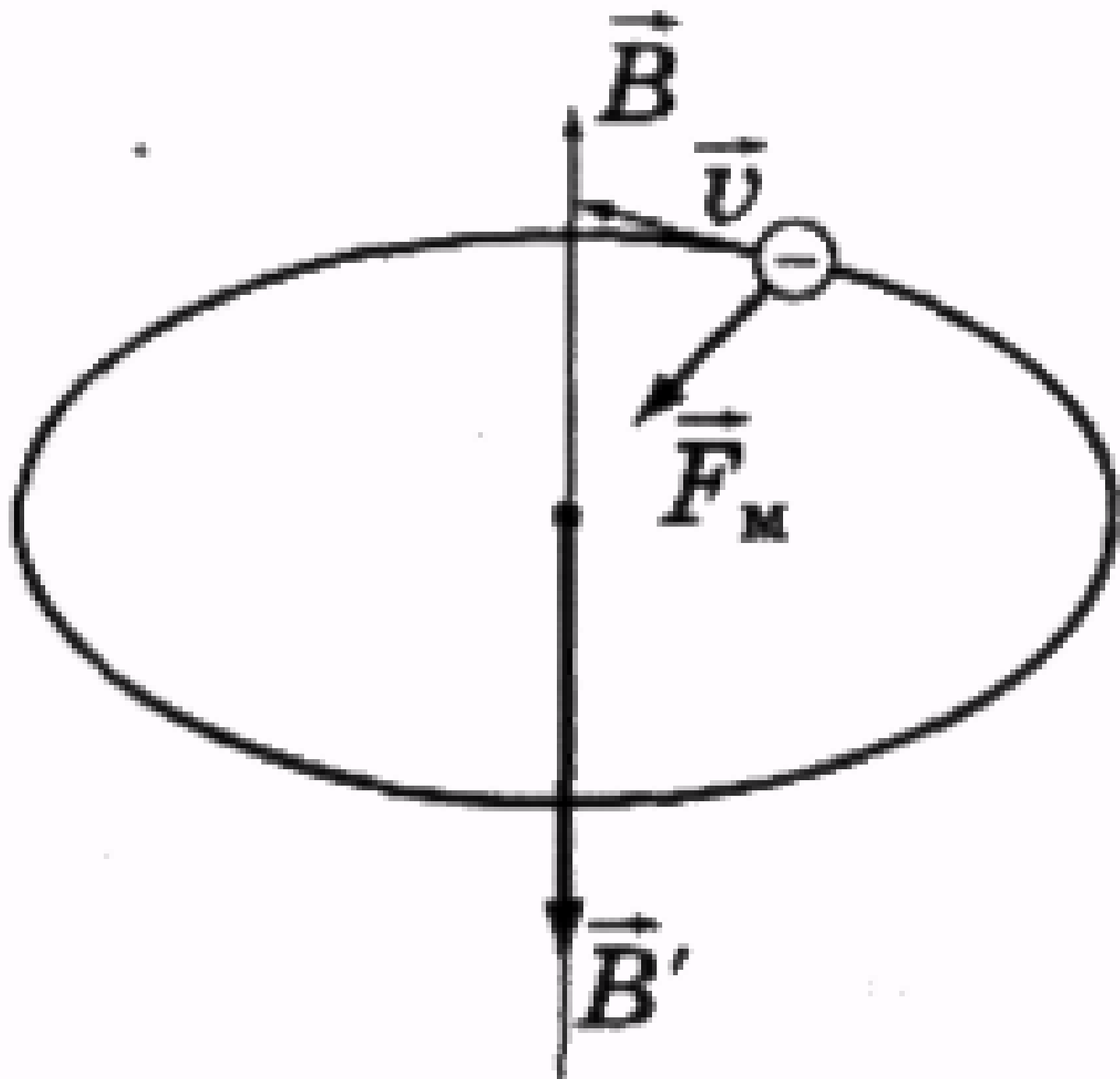

Мал. 2.146



11

=

0

.

0

0

0

0

0

1

.



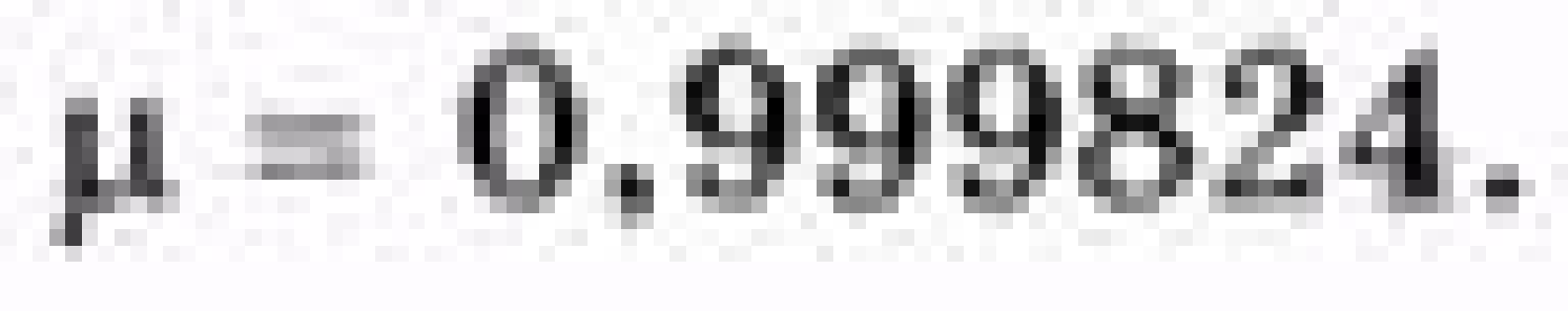

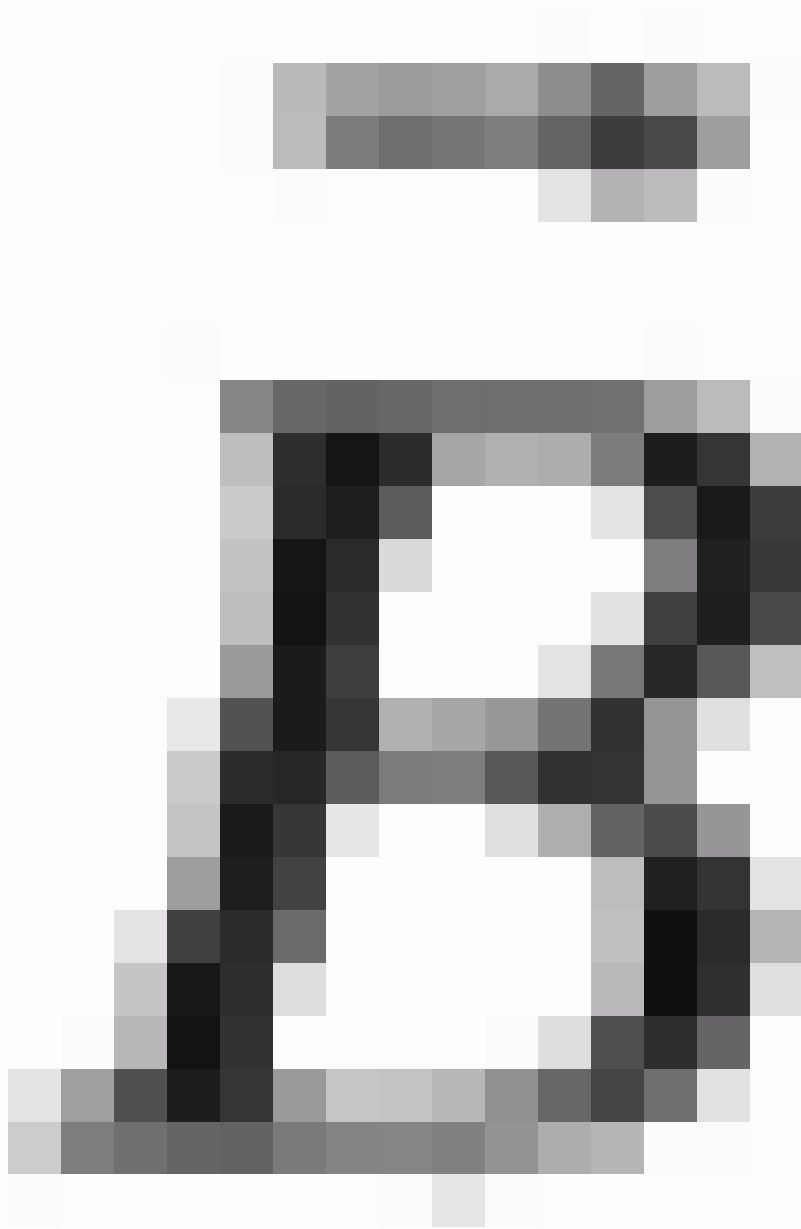

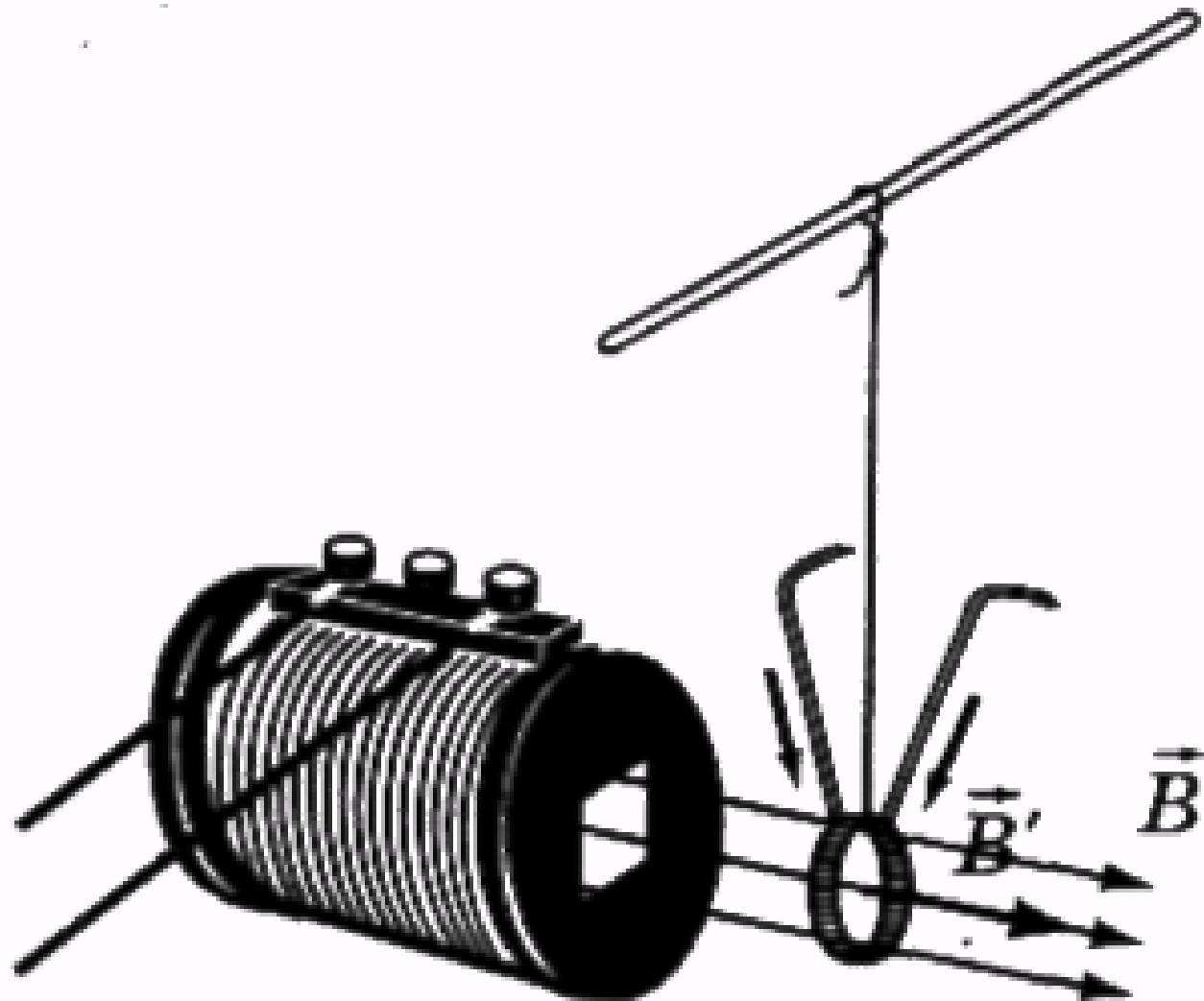

Мал. 2.147

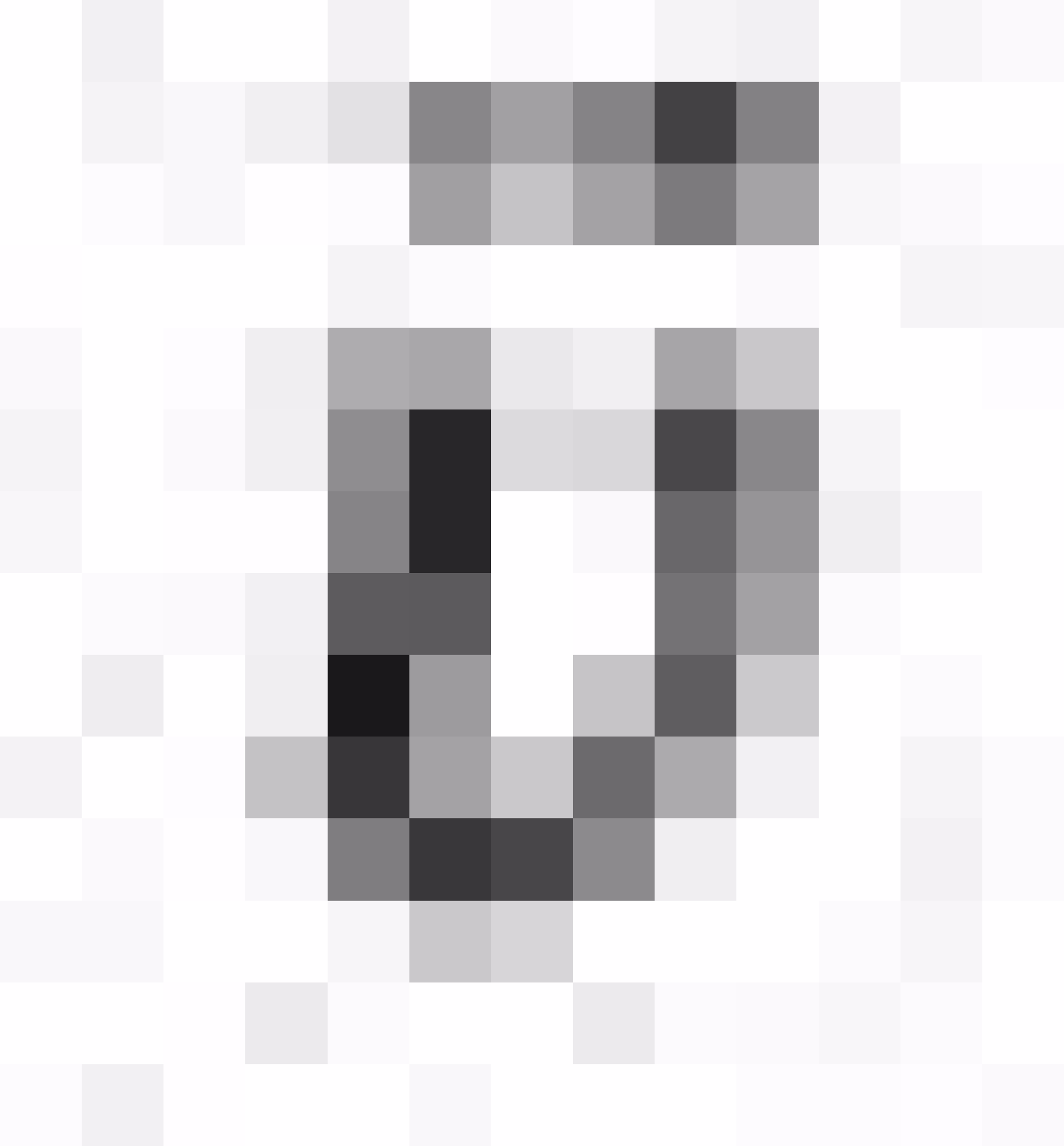

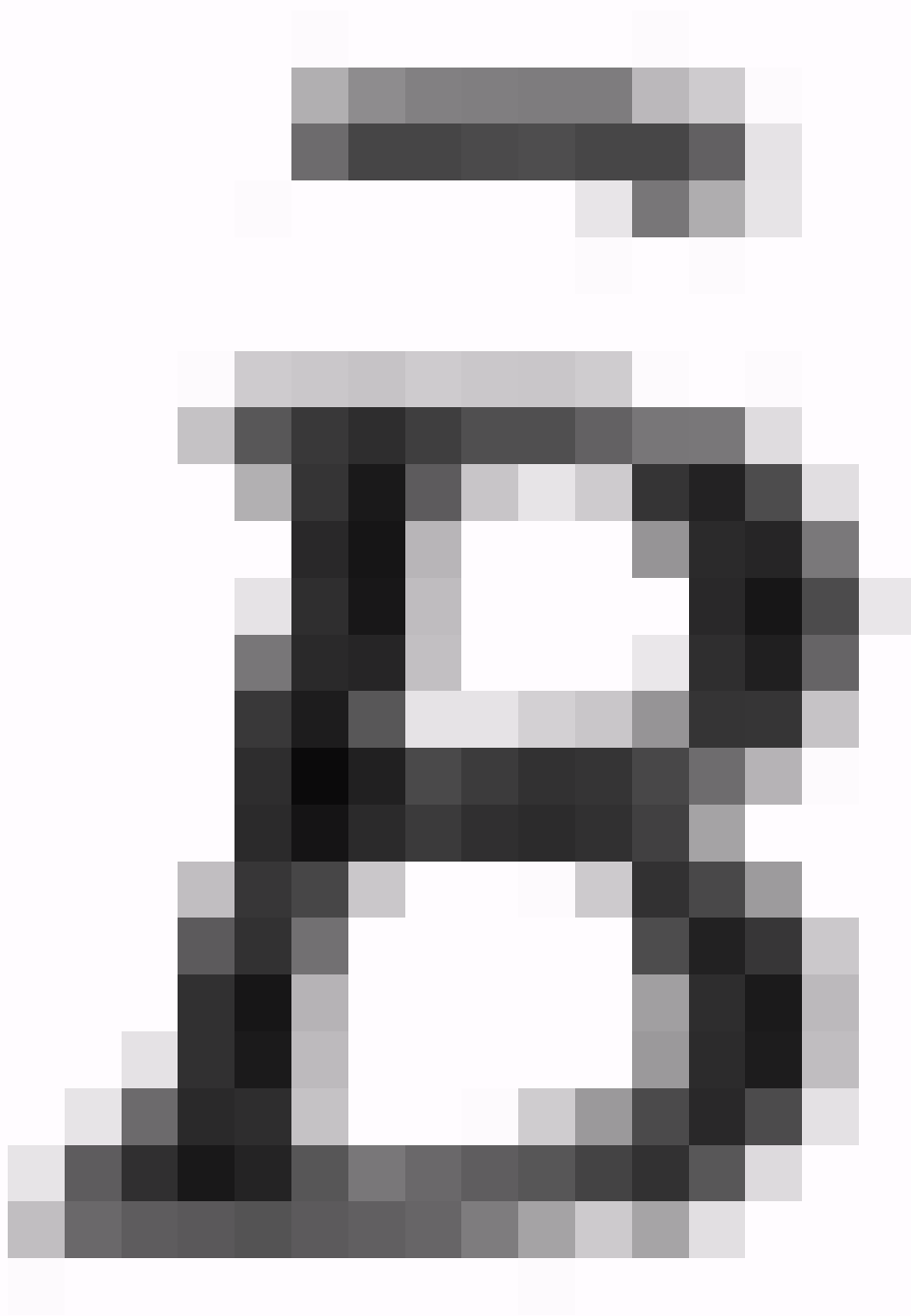

$$\vec{B} = 0$$

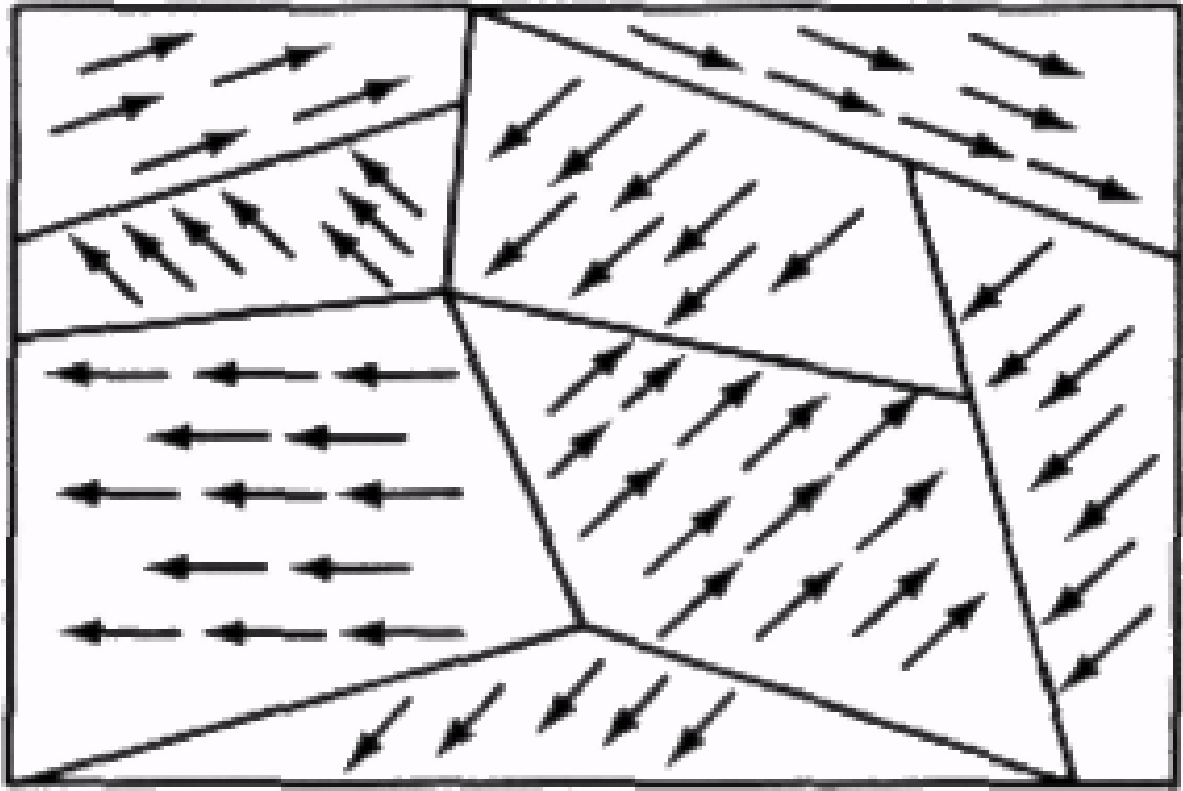

$$\vec{B}$$

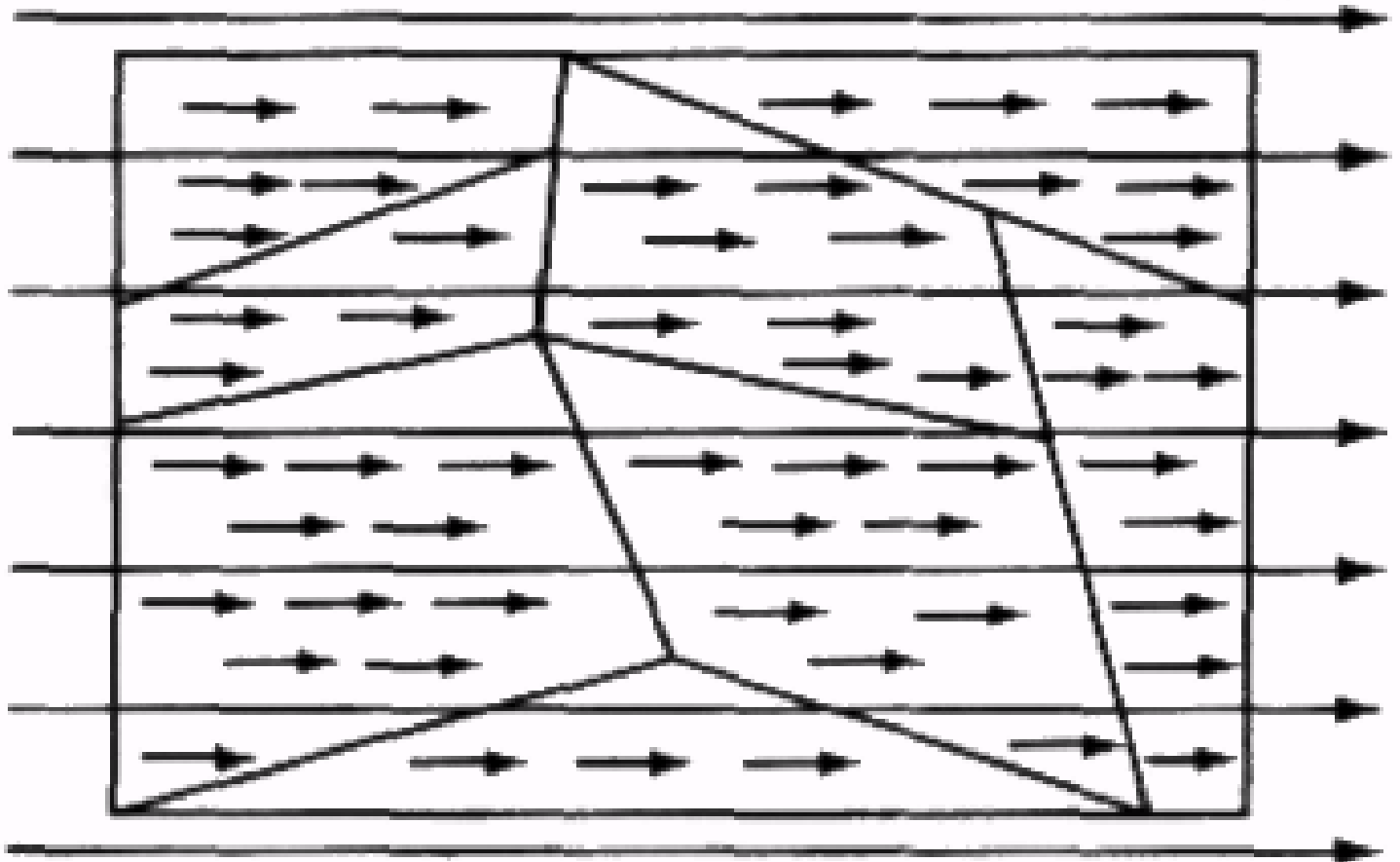

Мал. 2.148



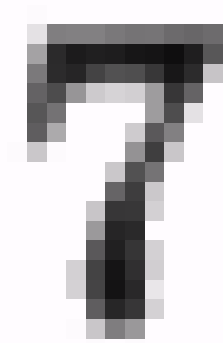
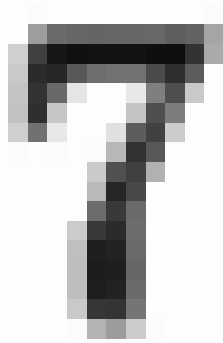
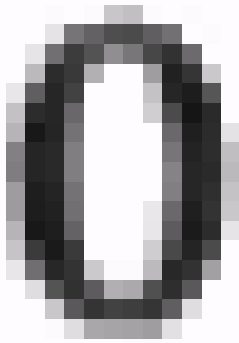
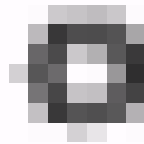
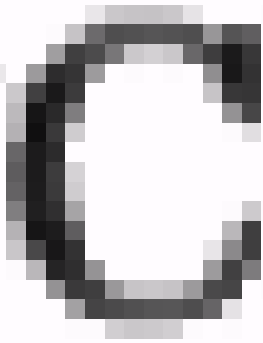

A pixelated, grayscale uppercase letter 'T'. The letter is composed of a thick horizontal top bar and a vertical stem. The pixels are rendered in various shades of gray, giving it a textured, blocky appearance.A pixelated, grayscale uppercase letter 'T', identical to the first one. It features a thick horizontal top bar and a vertical stem, rendered in a grayscale pixel art style.A pixelated, grayscale uppercase letter 'O'. The letter is formed by a thick, rounded stroke, creating a hollow center. The pixels are in various shades of gray, giving it a textured appearance.A pixelated, grayscale lowercase letter 'o'. It is a small, circular letter with a thick stroke and a hollow center, rendered in a grayscale pixel art style.A pixelated, grayscale uppercase letter 'C'. The letter is formed by a thick, curved stroke, creating a hollow center. The pixels are in various shades of gray, giving it a textured appearance.A pixelated, grayscale lowercase letter 's'. The letter is formed by a thick, curved stroke, creating a hollow center. The pixels are in various shades of gray, giving it a textured appearance.

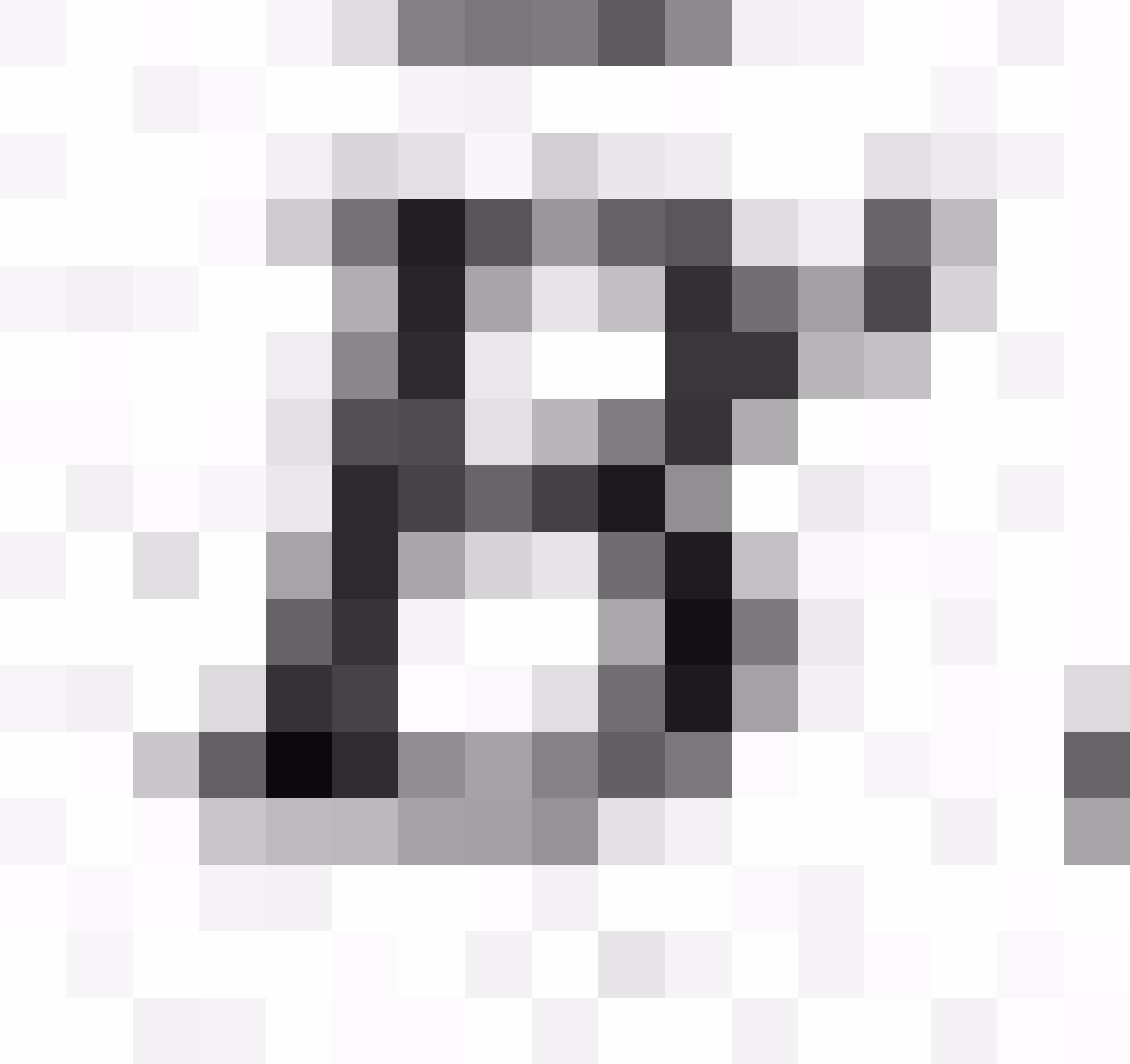

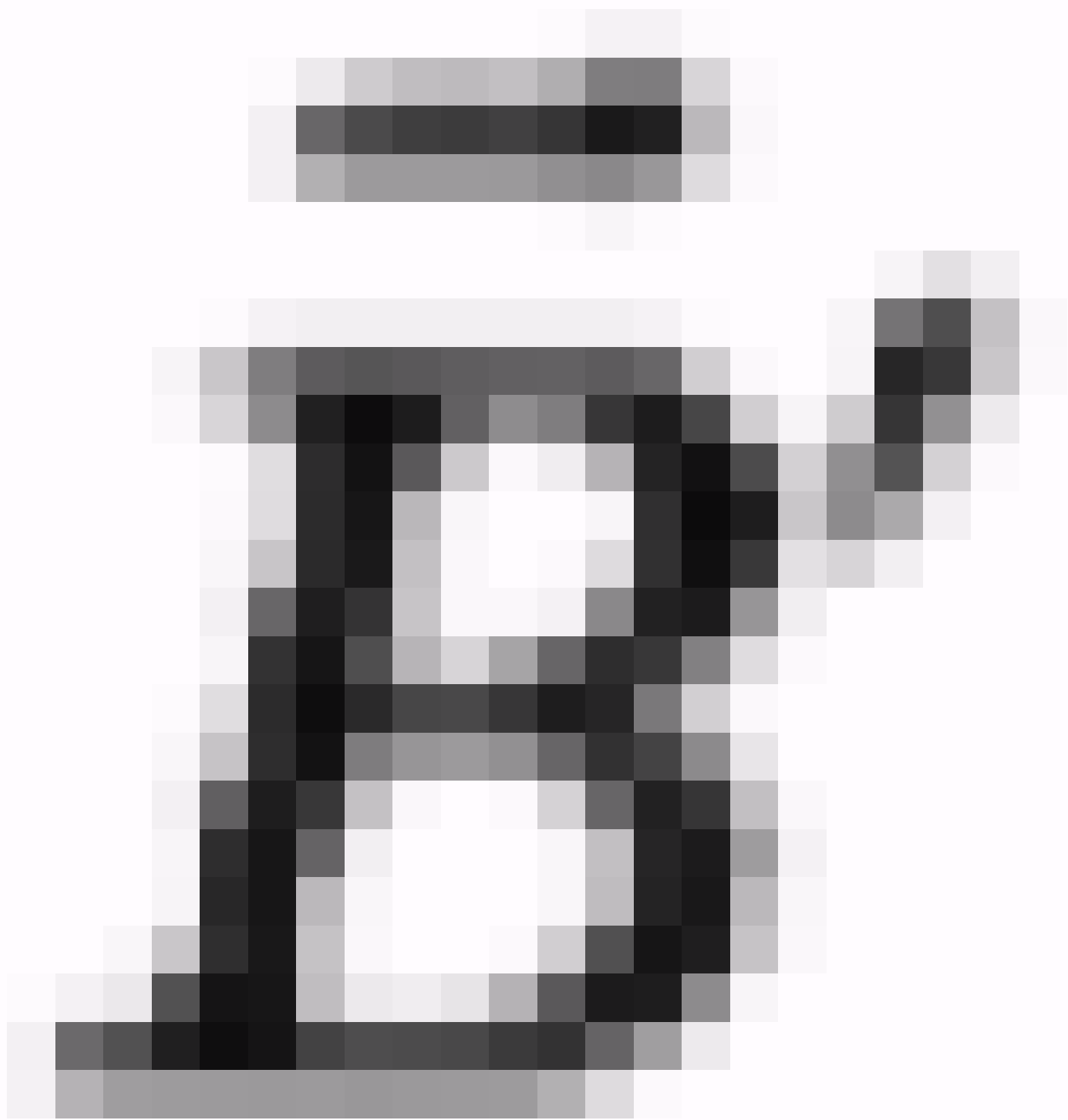

A pixelated, grayscale representation of the lowercase letter 'a'. The letter is formed by a thick, dark stroke with a lighter, grayish outline, giving it a 3D or embossed appearance. The top of the letter is rounded, and the bottom has a slight curve.

A pixelated, grayscale representation of the lowercase letter 'b'. The letter is formed by a thick, dark stroke with a lighter, grayish outline. It features a vertical stem on the right side and a rounded, bowl-like top on the left.

A pixelated, grayscale representation of the lowercase letter 'o'. The letter is formed by a thick, dark stroke with a lighter, grayish outline. It is a simple, rounded shape with a slight indentation at the top.

A pixelated, grayscale representation of the lowercase letter 'w'. The letter is formed by a thick, dark stroke with a lighter, grayish outline. It consists of two 'u'-like shapes joined together, with a small gap between them.

A pixelated, grayscale representation of the lowercase letter 'e'. The letter is formed by a thick, dark stroke with a lighter, grayish outline. It is a simple, rounded shape with a small opening at the top.

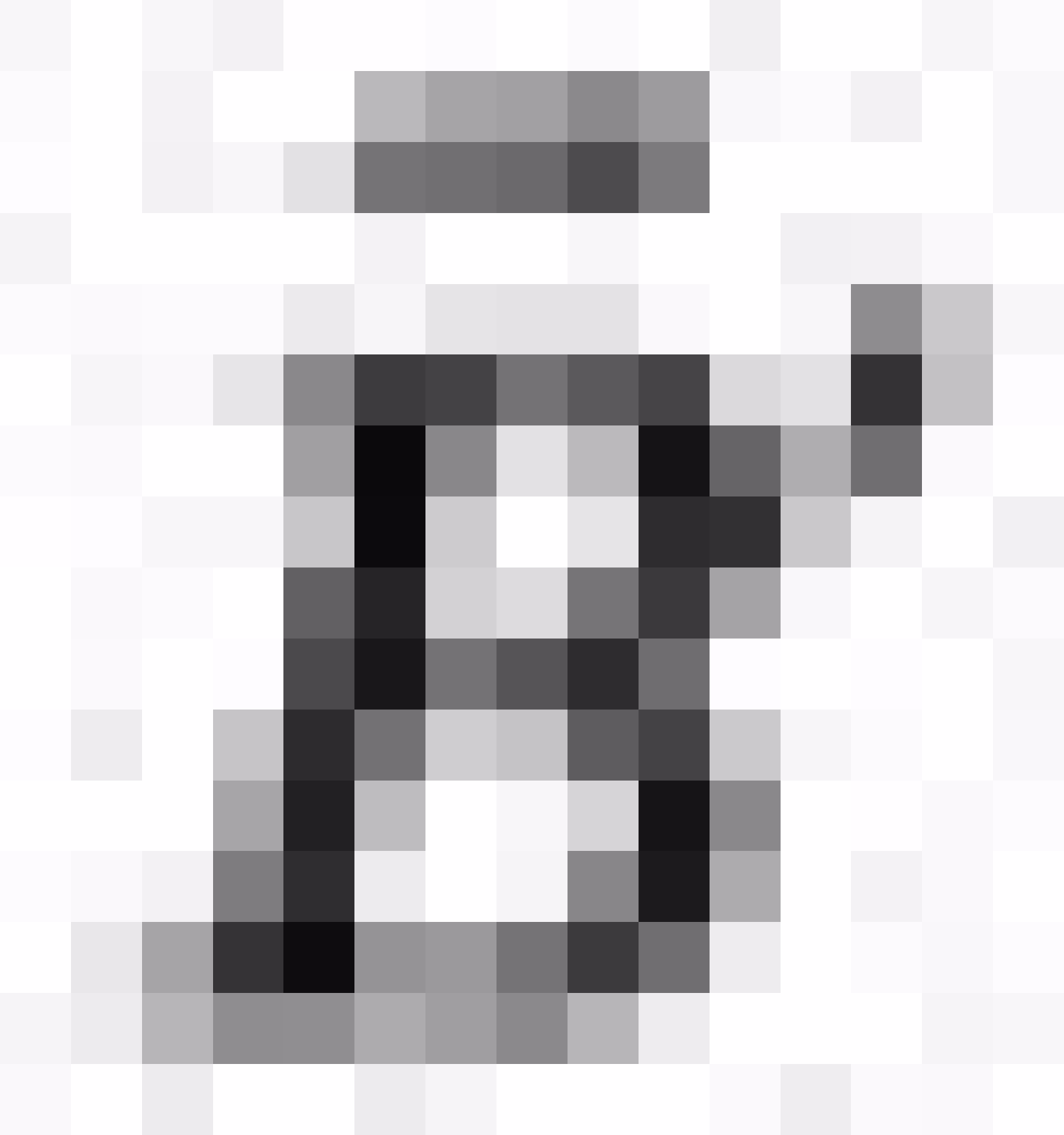



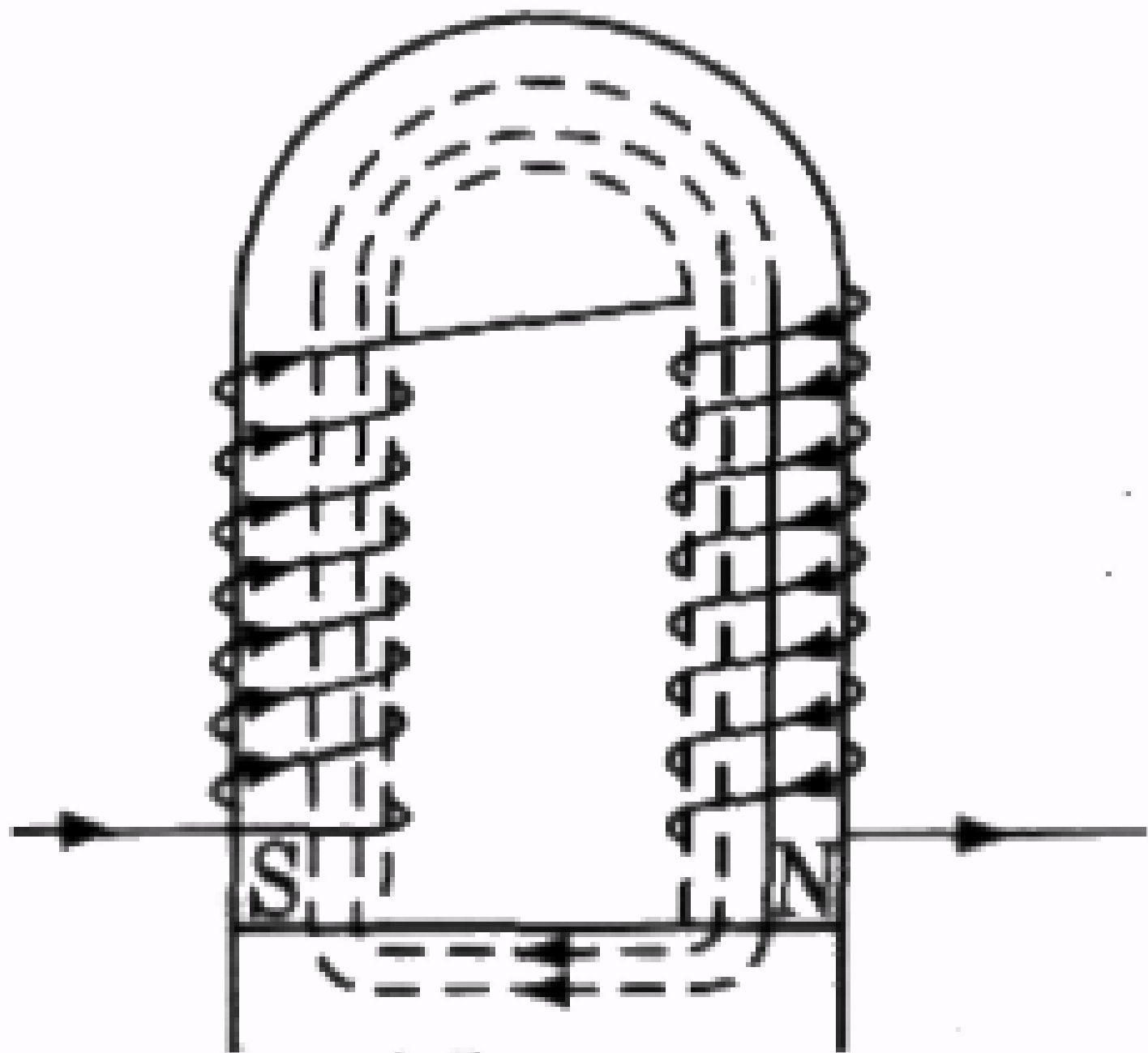

Мал. 2.149



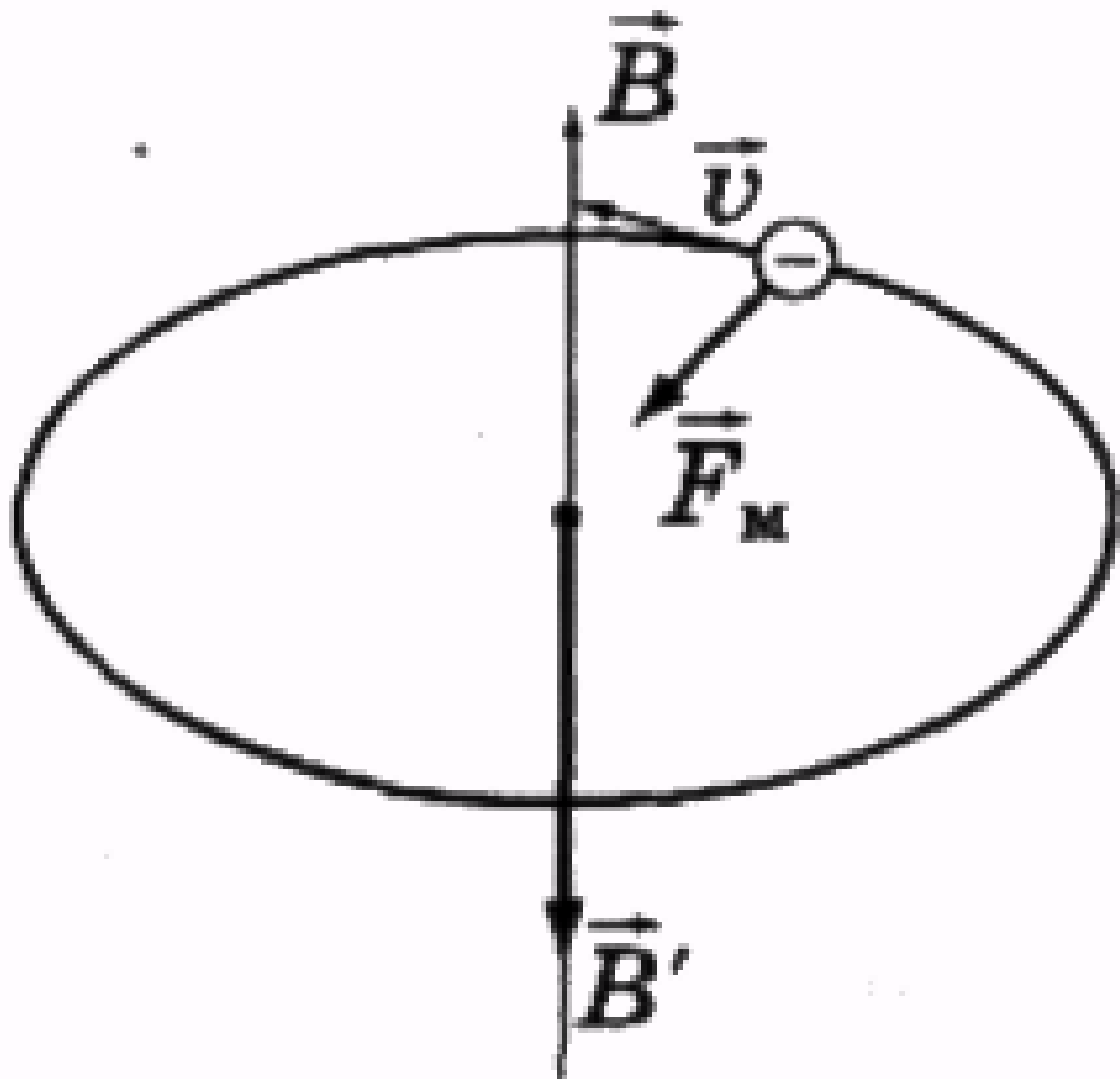

Мал. 2.146

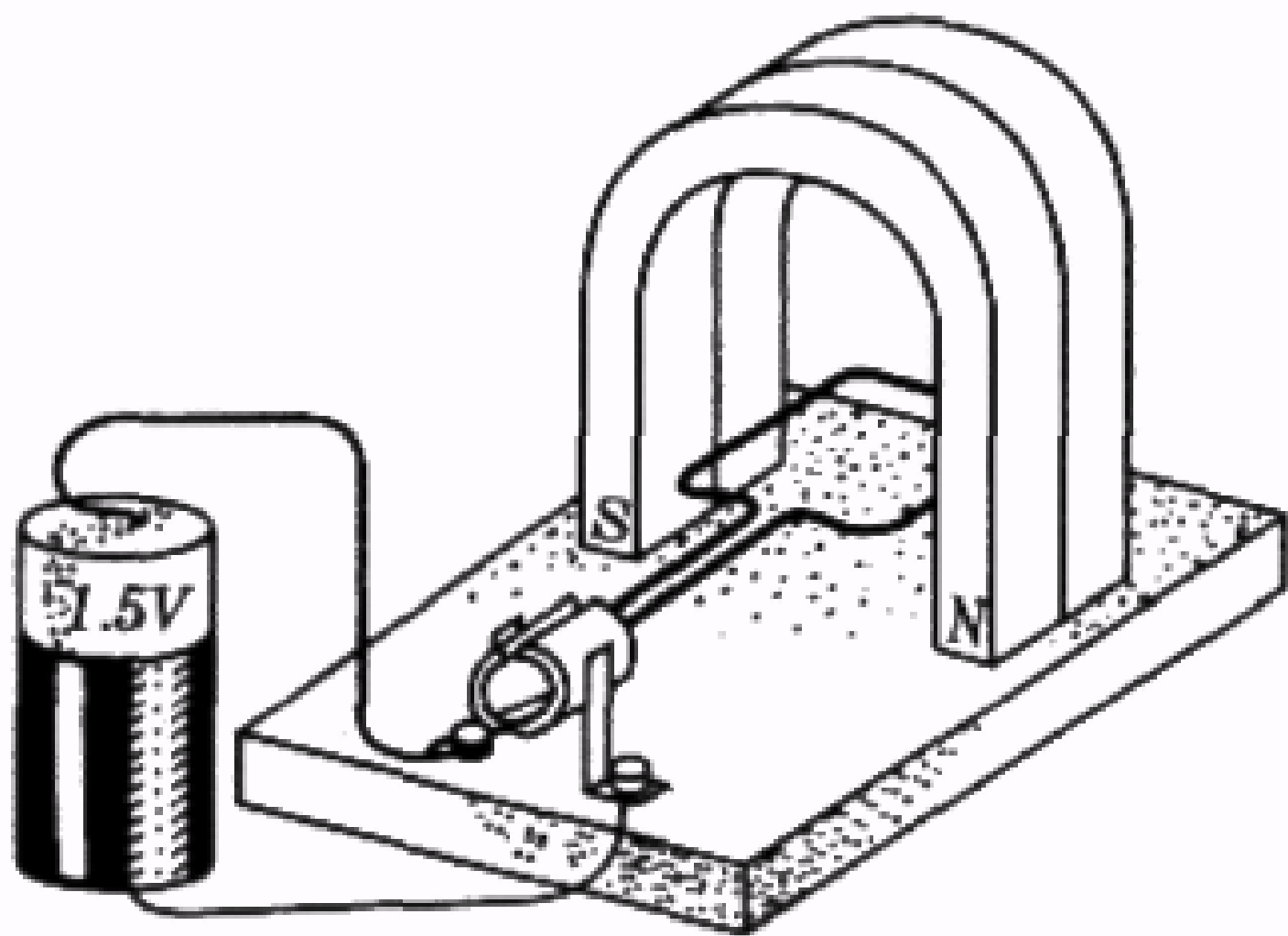

Мал. 2.150

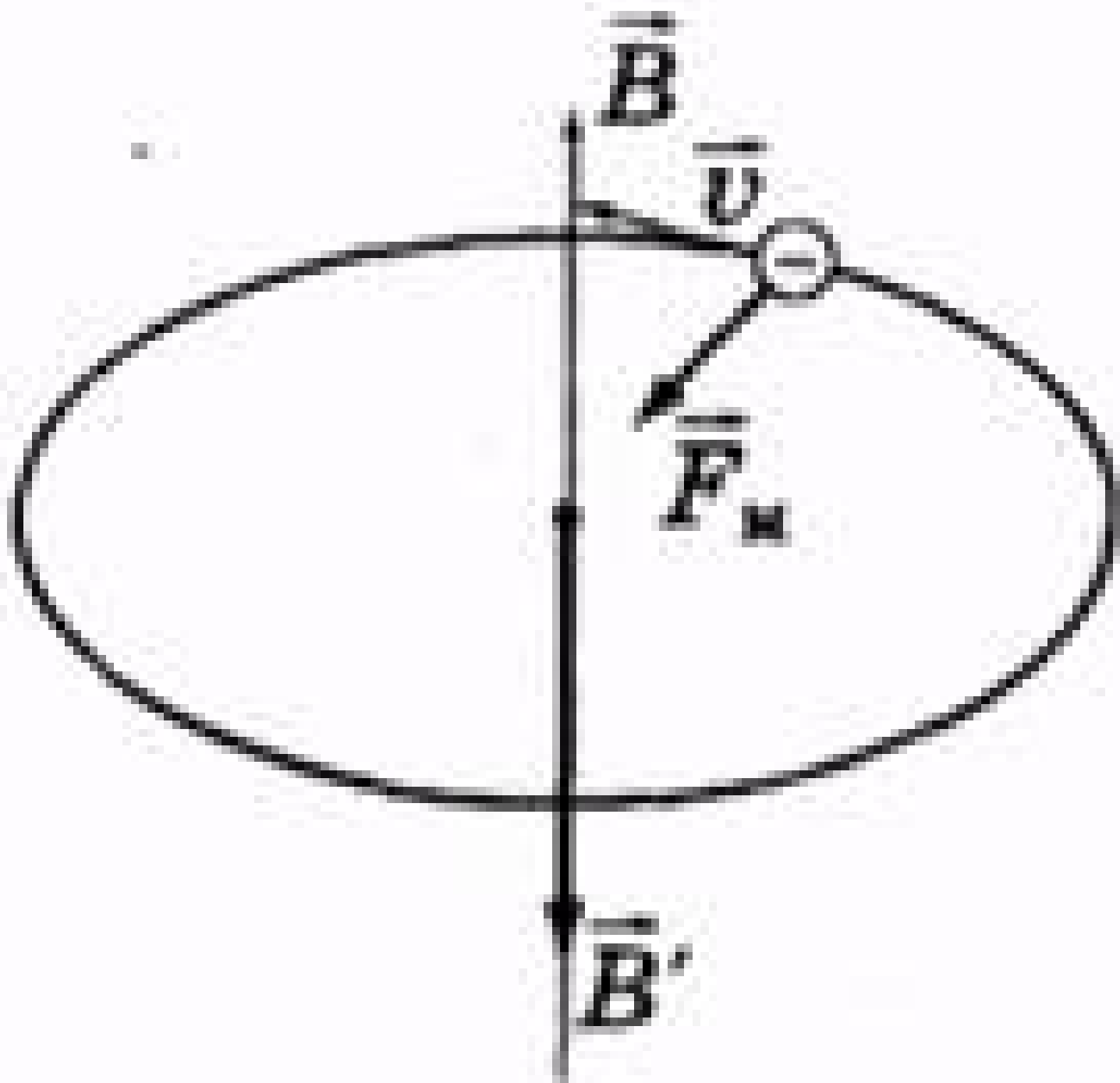

Mat. 2.146





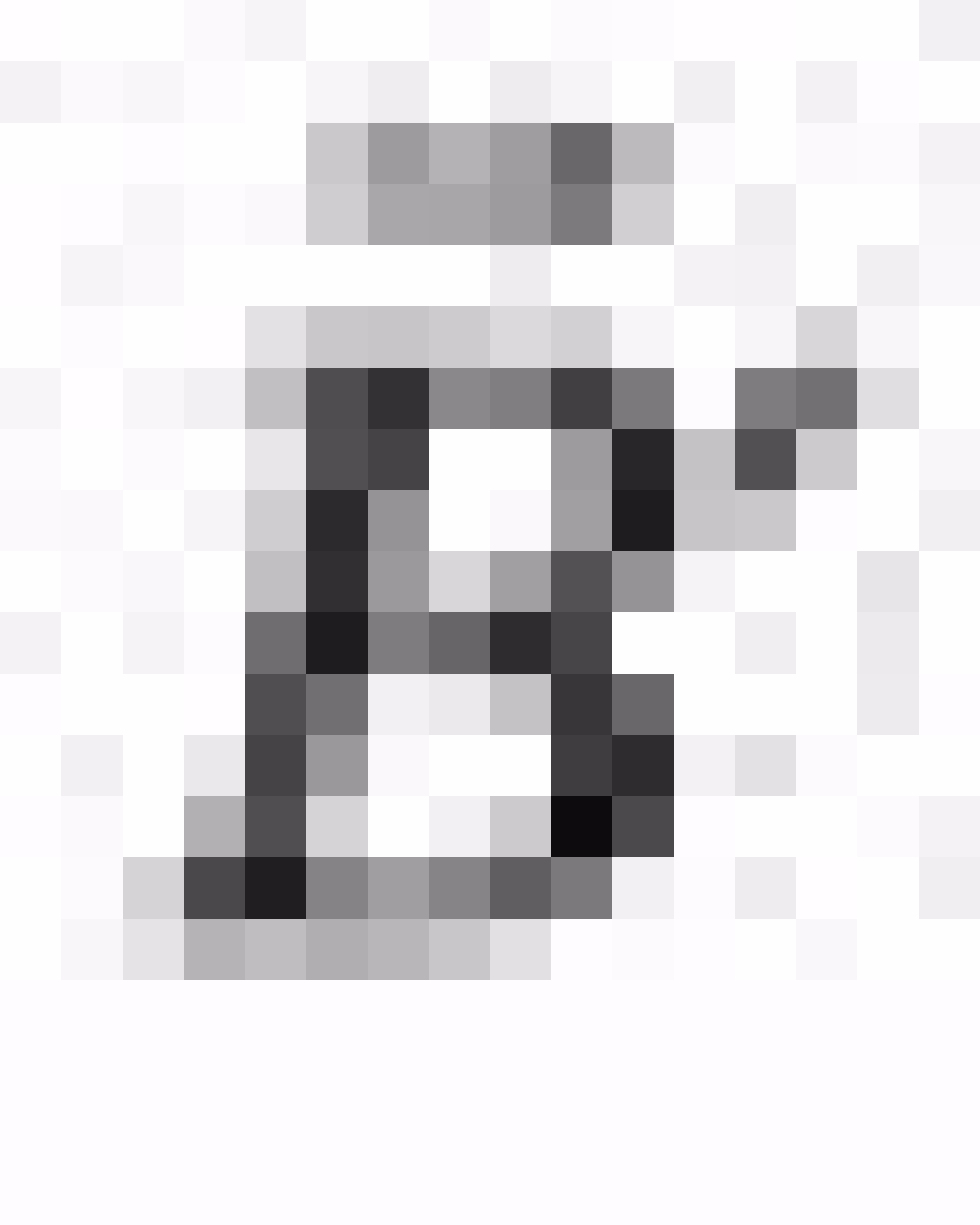

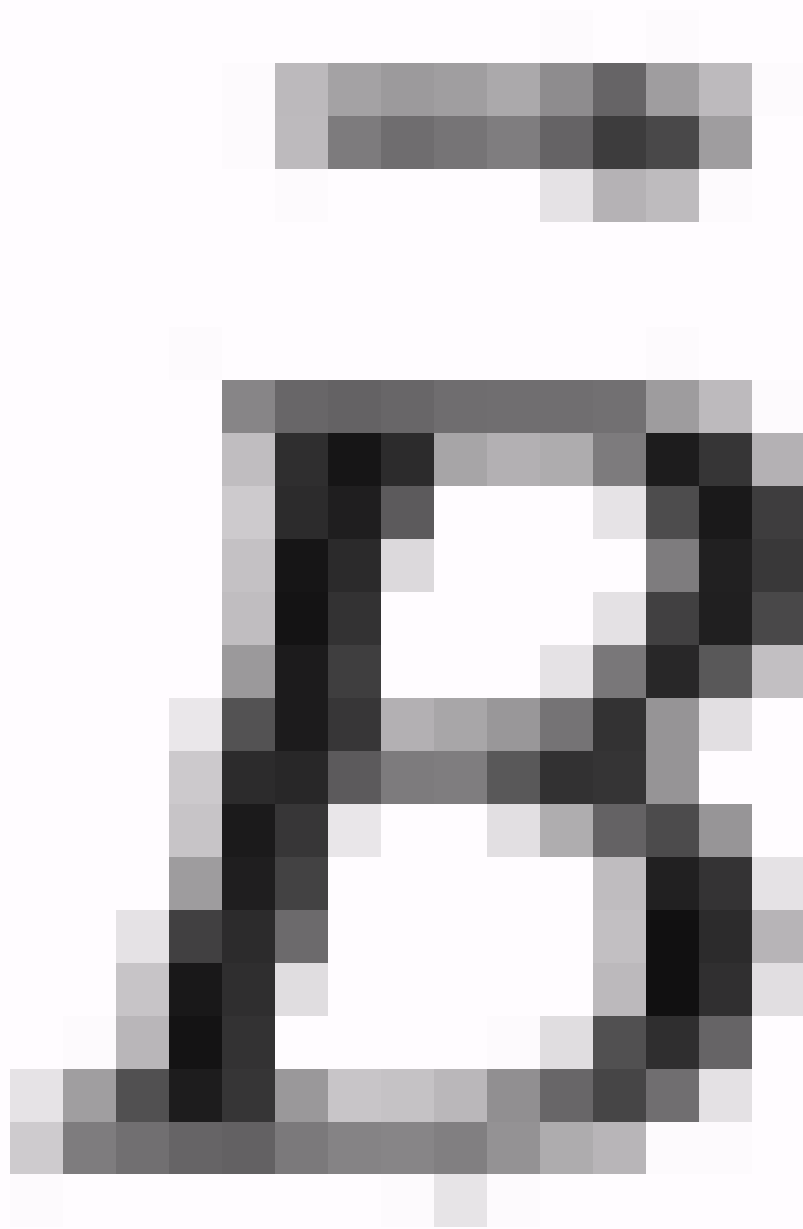

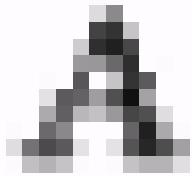
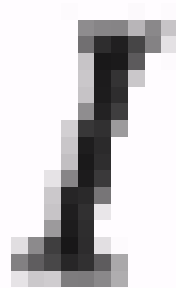
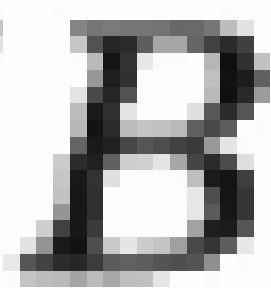
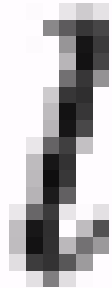
A pixelated, black and white representation of the uppercase letter 'F'. The letter has a thick vertical stem on the left and a horizontal top bar. The right side of the top bar is slightly irregular, suggesting a hand-drawn or low-resolution digital style.A pixelated, black and white representation of the lowercase letter 'a'. It features a vertical stem on the right and a curved bowl on the left that meets the stem at the bottom. The letter is rendered in a simple, blocky style.A pixelated, black and white representation of the equals sign '='. It consists of two parallel horizontal bars of equal length, positioned one above the other with a small gap between them.A pixelated, black and white representation of the uppercase letter 'I'. It is a simple vertical bar with a slightly wider base and top, and a small hook-like detail at the top right corner.A pixelated, black and white representation of the uppercase letter 'B'. It has a vertical stem on the left and two rounded bowls on the right, one above the other. The letter is composed of several thick, pixelated strokes.A pixelated, black and white representation of the lowercase letter 'l'. It is a simple vertical bar with a slightly wider base and top, and a small hook-like detail at the top right corner.A pixelated, black and white representation of the lowercase letter 'i'. It consists of a vertical stem with a small dot above it, both rendered in a simple, blocky style.



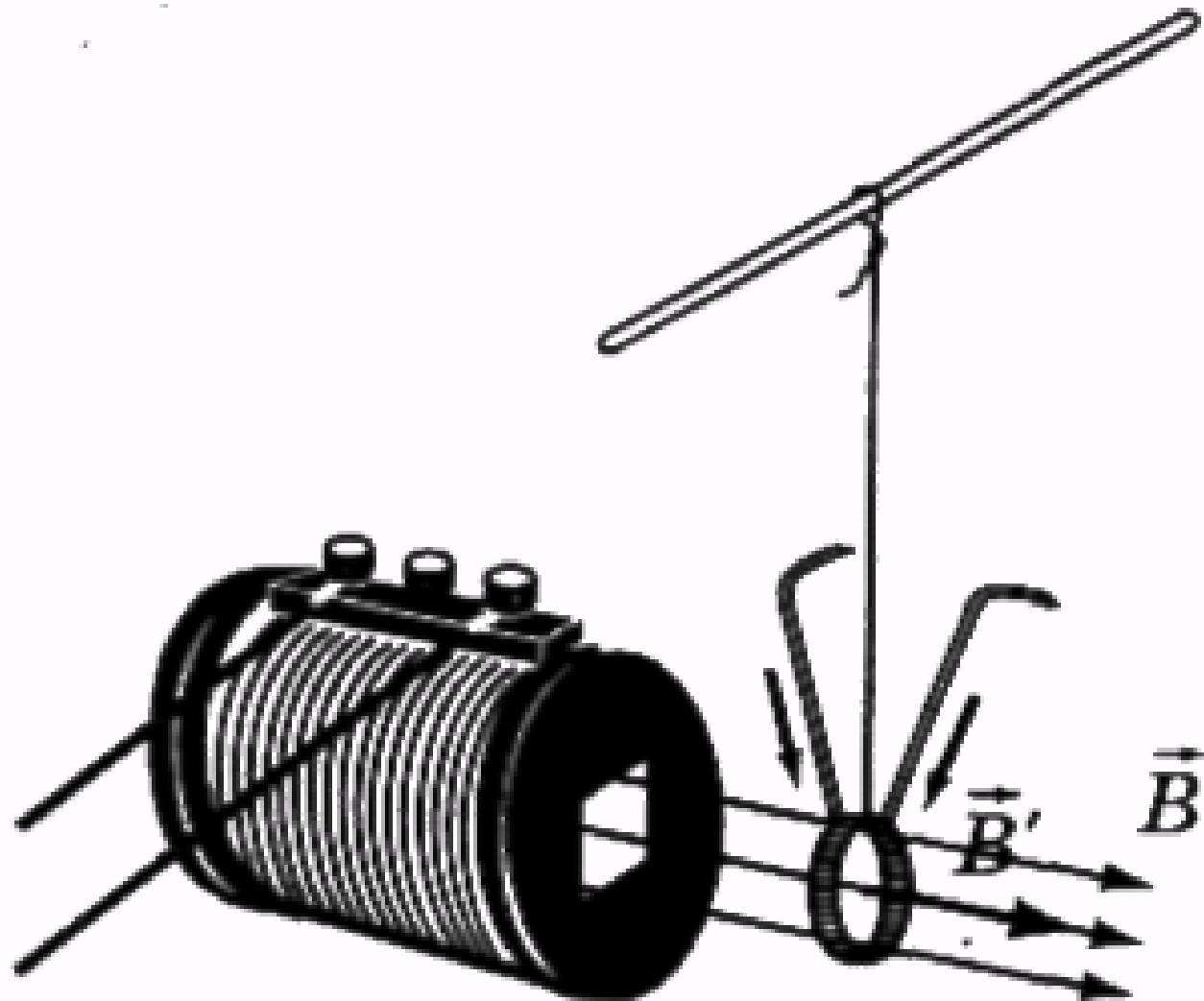

Мал. 2.147

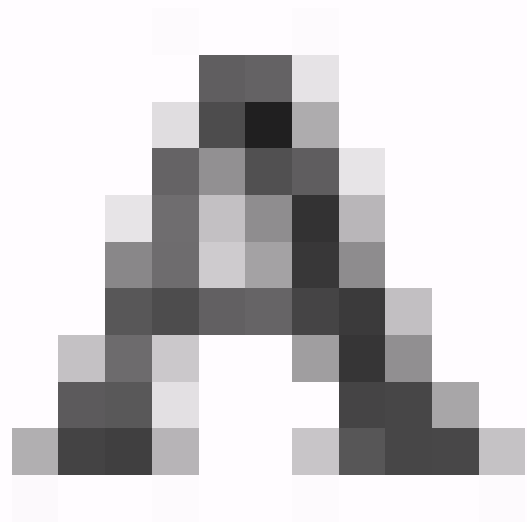
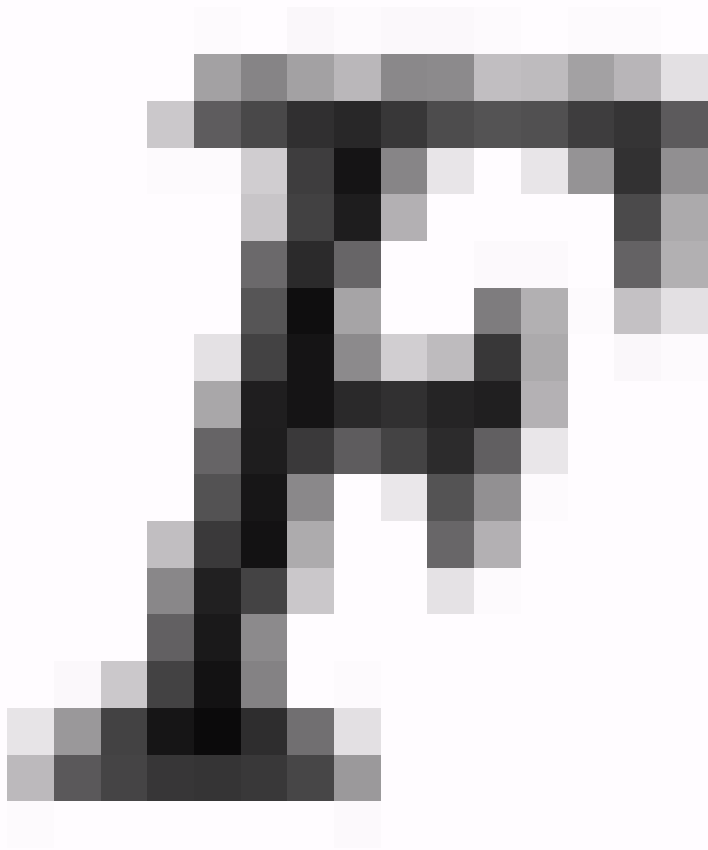

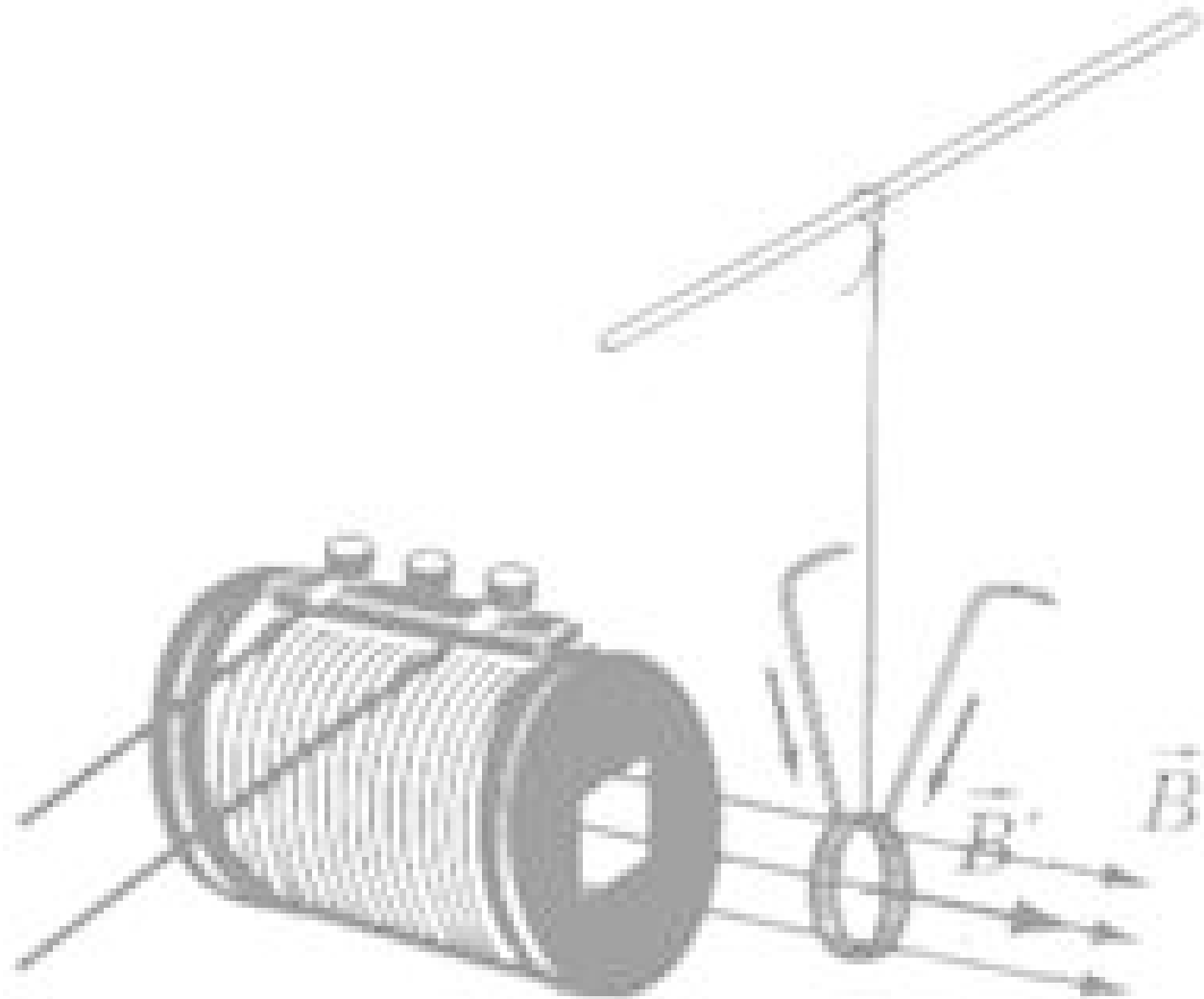

Мал. 2.147

$$\vec{B} = 0$$

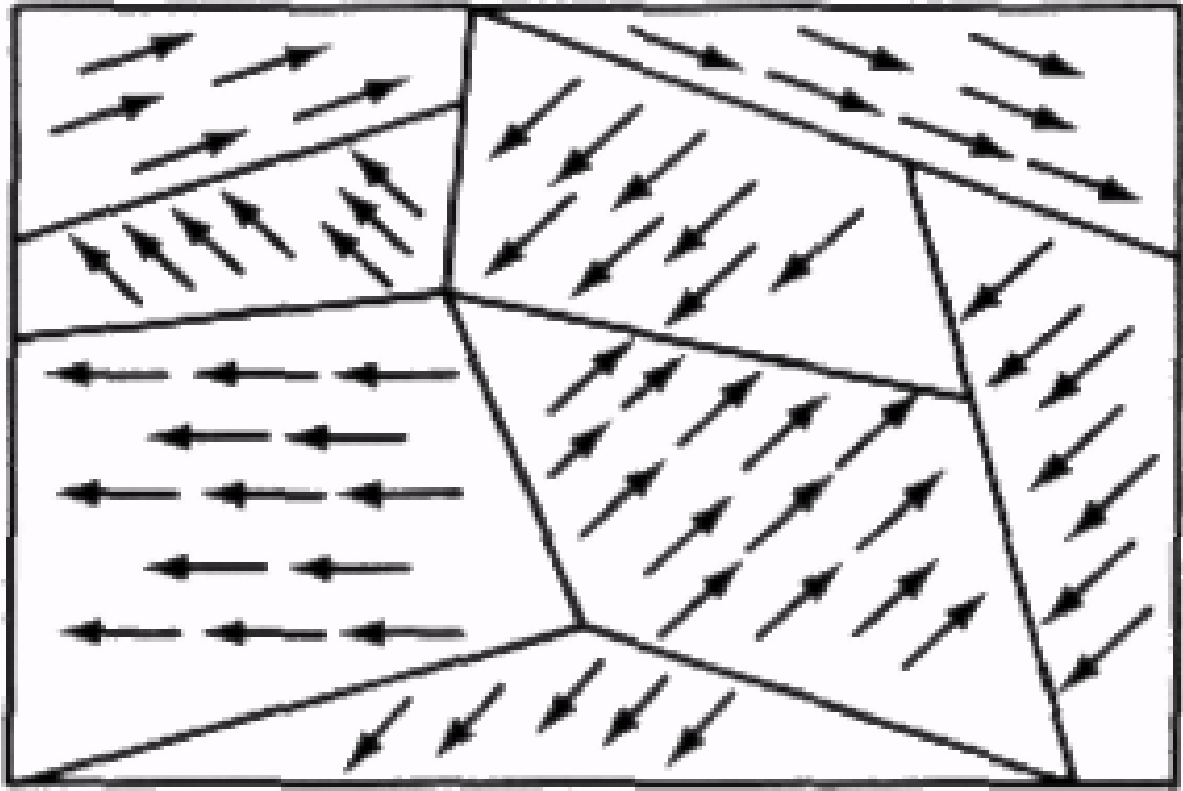

$$\vec{B}$$

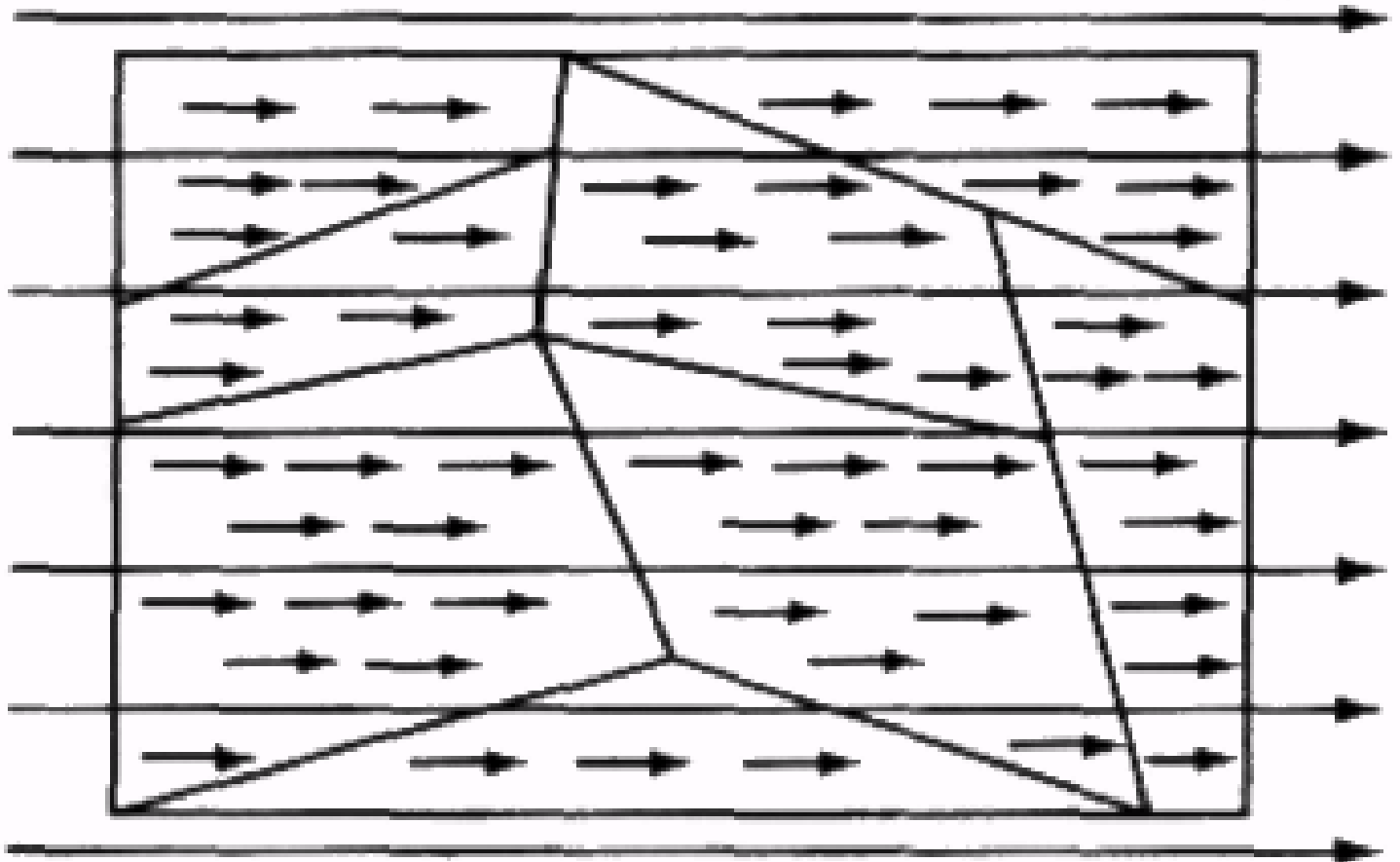

Мал. 2.148

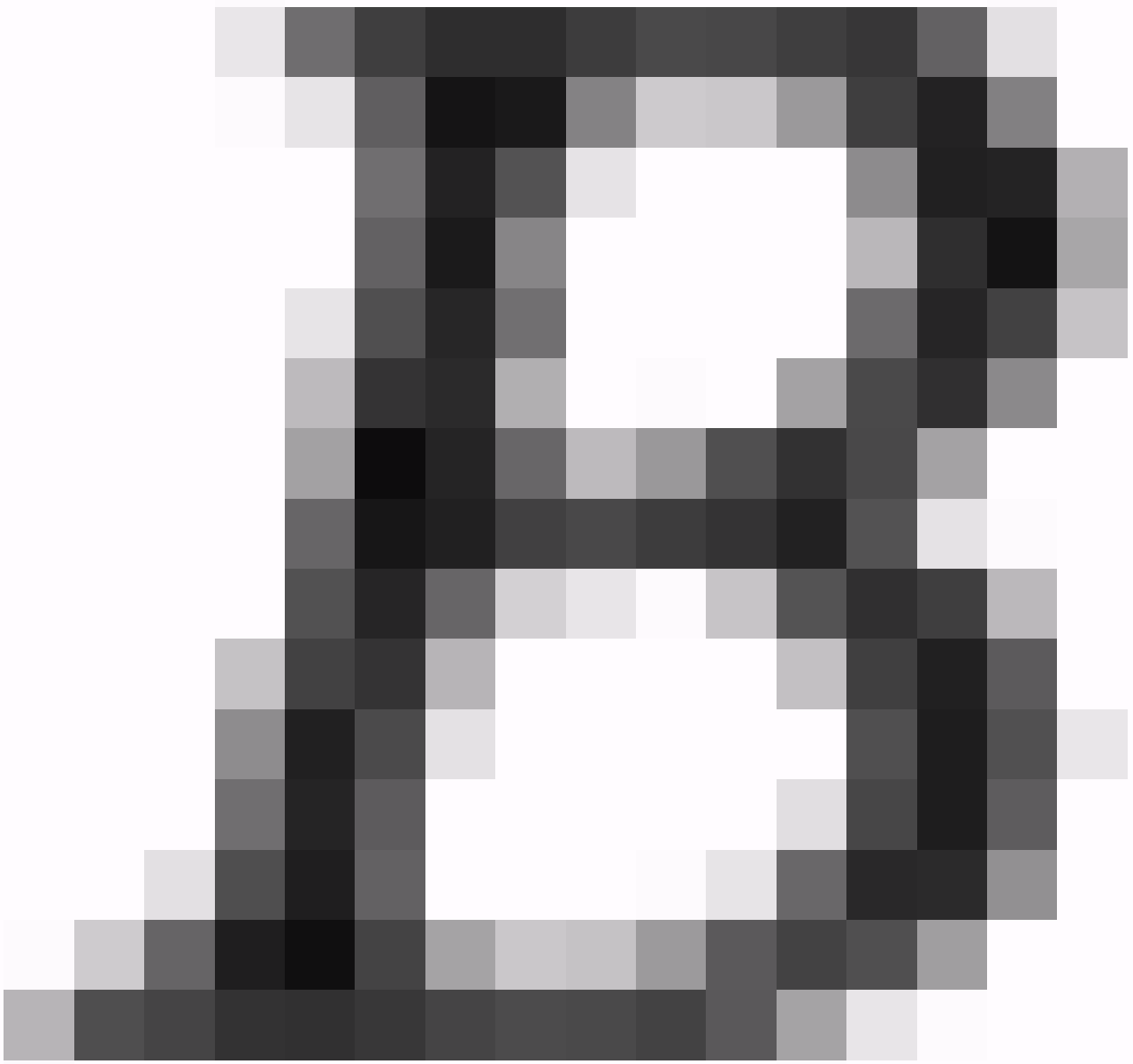

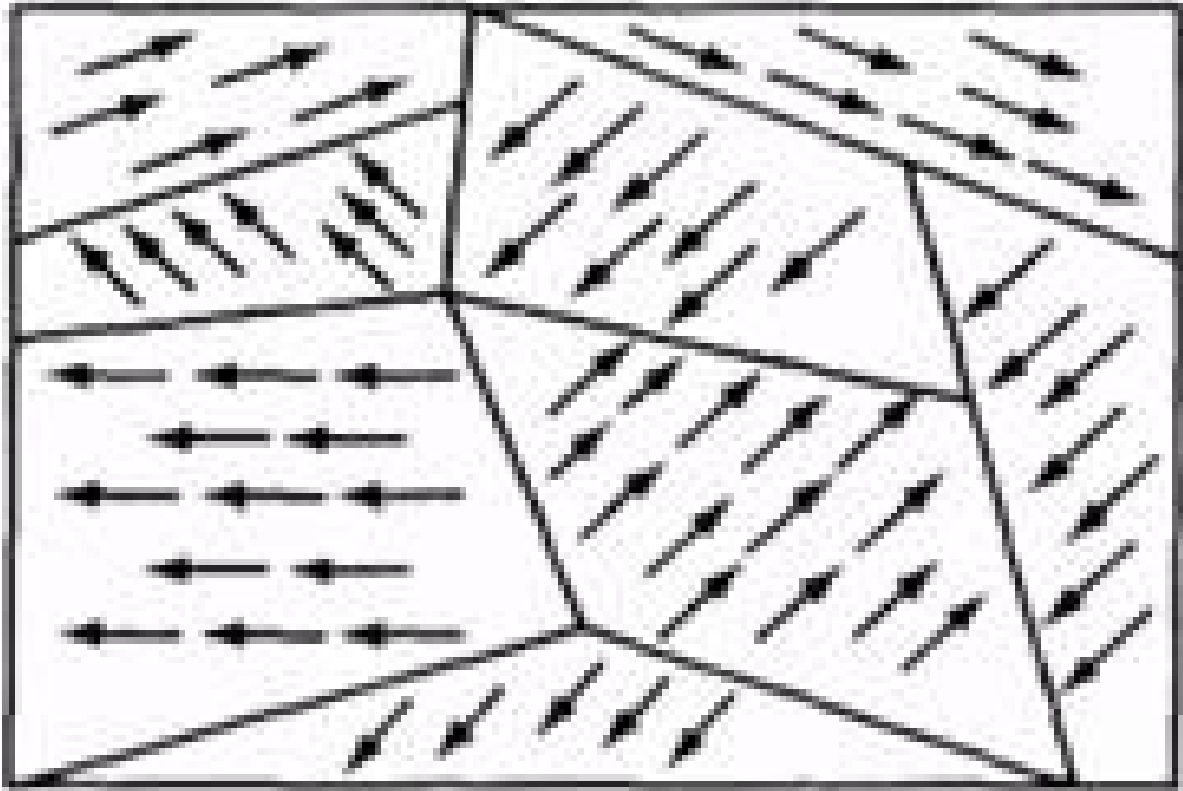

$$\bar{B} = 0$$

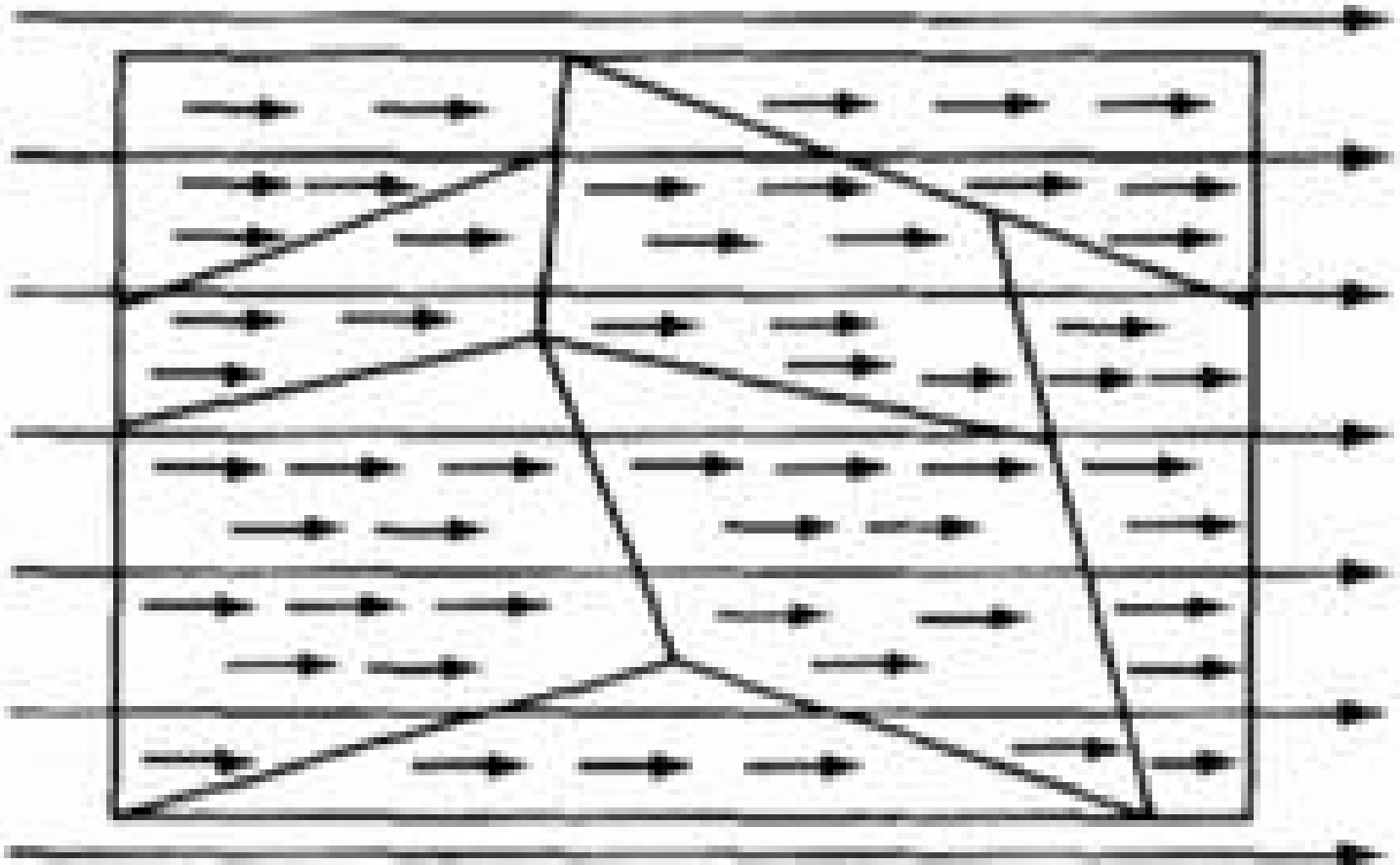

$$\bar{B}$$

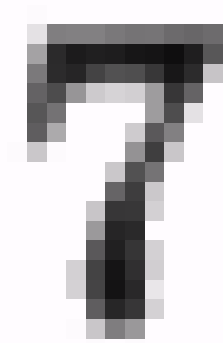
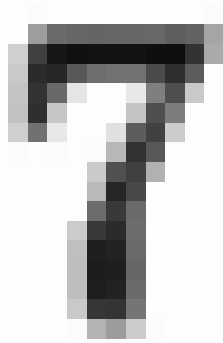
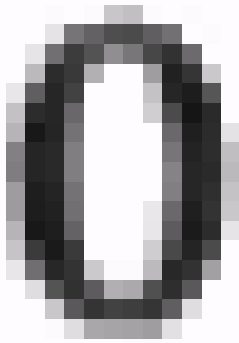
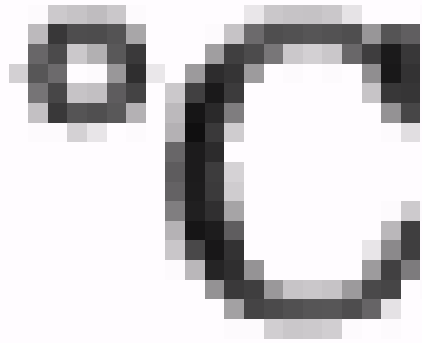

Мал. 2.148

A pixelated, grayscale representation of the uppercase letter 'T'. The letter is composed of a thick horizontal top bar and a vertical stem that tapers slightly towards the bottom. The edges are jagged due to the low resolution.A pixelated, grayscale representation of the uppercase letter 'T', identical to the first one. It features a thick horizontal top bar and a vertical stem with a slight taper at the bottom.A pixelated, grayscale representation of the uppercase letter 'O'. It is a thick, rounded shape with a white center, formed by a single continuous stroke. The edges are pixelated.A pixelated, grayscale representation of the uppercase letter 'O', identical to the third one. It is a thick, rounded shape with a white center, formed by a single continuous stroke.A pixelated, grayscale representation of the lowercase letter 's'. It is a small, curved shape with a white center, formed by a single continuous stroke. The edges are pixelated.

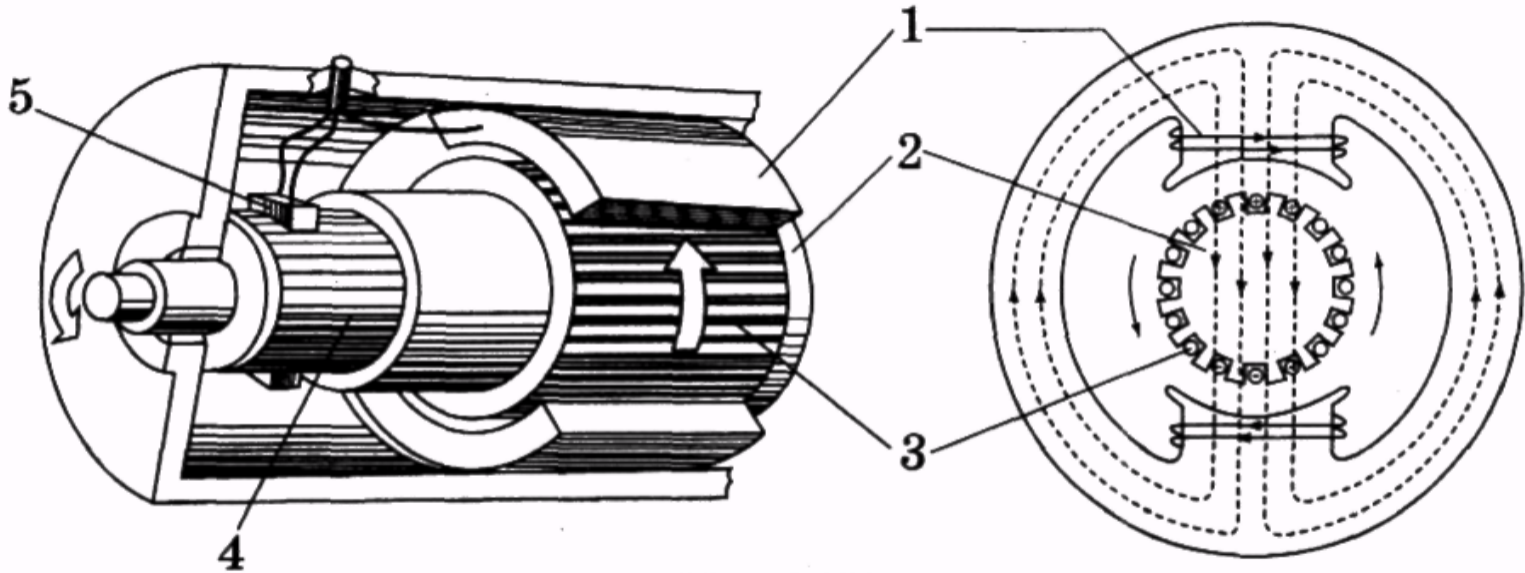

Мал. 2.151

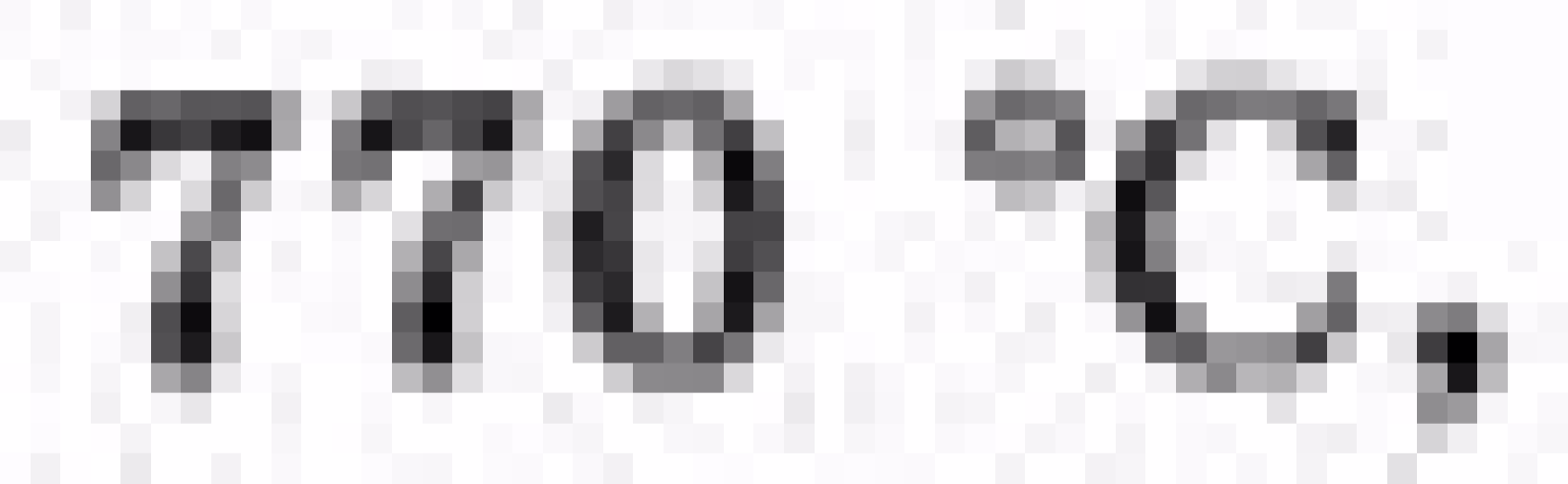

A pixelated, grayscale representation of the number 3. The character is composed of a grid of black and gray pixels, giving it a blocky, digital appearance. It features a vertical stem on the right side and a horizontal base at the bottom.

A pixelated, grayscale representation of the number 5. The character is composed of a grid of black and gray pixels, giving it a blocky, digital appearance. It features a horizontal top bar and a vertical stem on the right side.

A pixelated, grayscale representation of the number 0. The character is composed of a grid of black and gray pixels, giving it a blocky, digital appearance. It features a horizontal top bar and a horizontal base at the bottom.

A pixelated, grayscale representation of the number 0. The character is composed of a grid of black and gray pixels, giving it a blocky, digital appearance. It features a horizontal top bar and a horizontal base at the bottom.

A pixelated, grayscale representation of the number 0. The character is composed of a grid of black and gray pixels, giving it a blocky, digital appearance. It features a horizontal top bar and a horizontal base at the bottom.

A pixelated, grayscale representation of the number 0. The character is composed of a grid of black and gray pixels, giving it a blocky, digital appearance. It features a horizontal top bar and a horizontal base at the bottom.

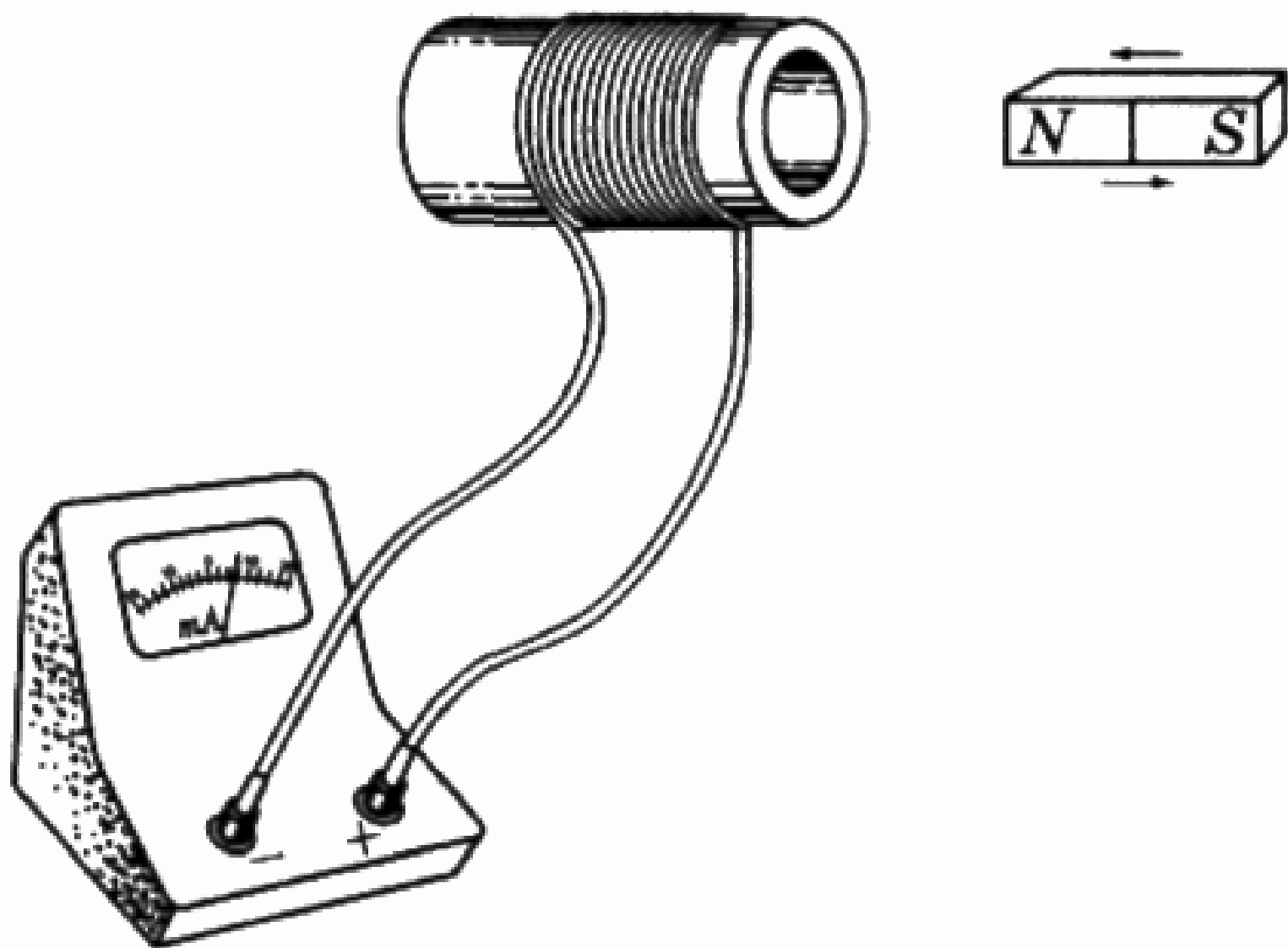

Мал. 2.152

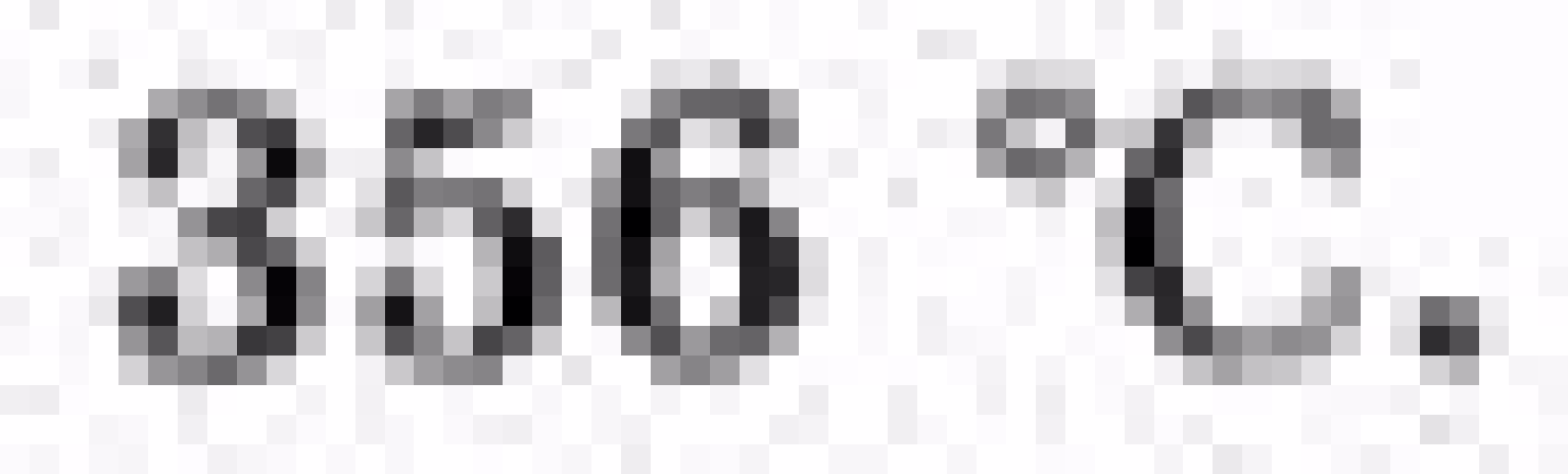

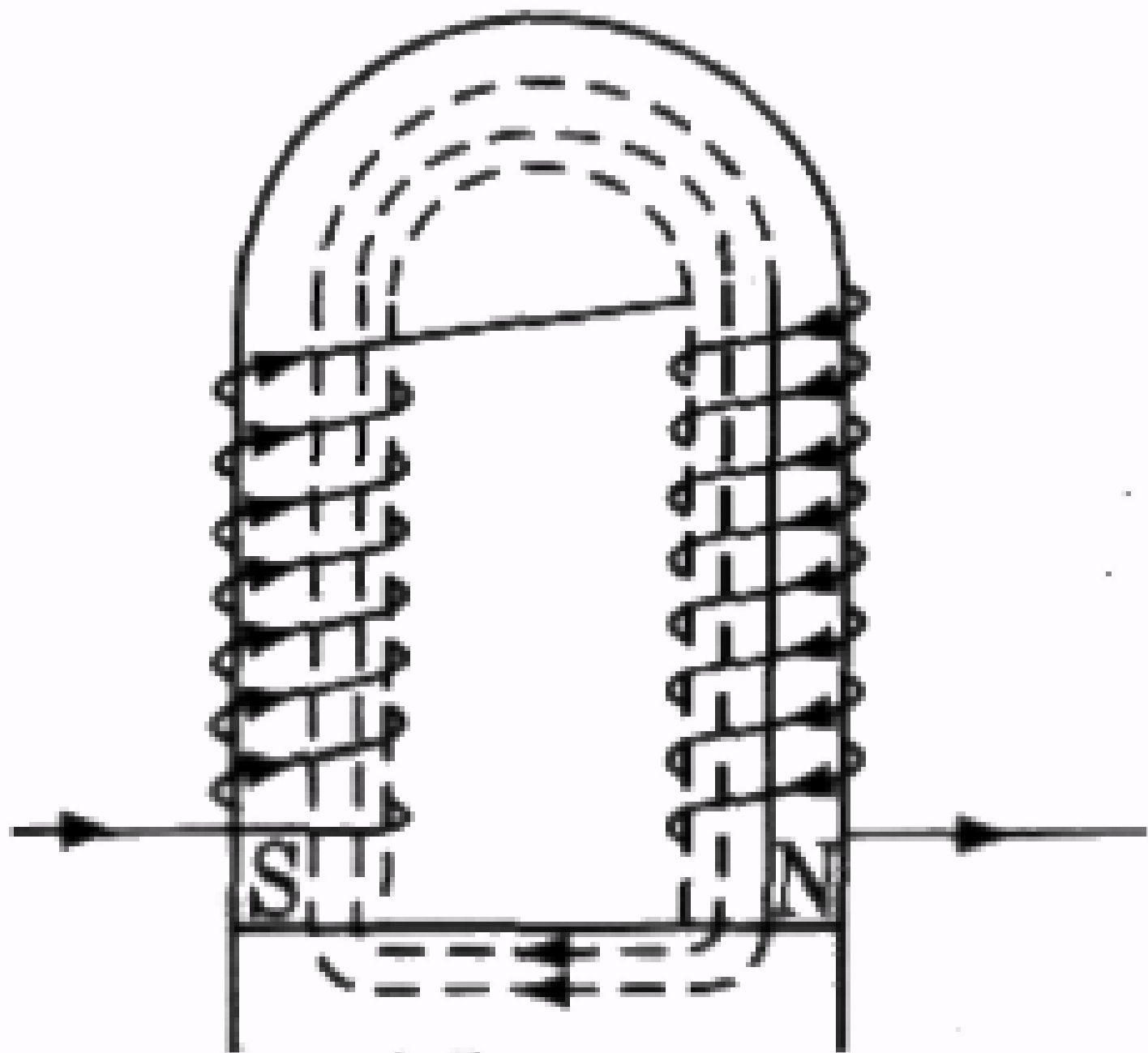

Мал. 2.149

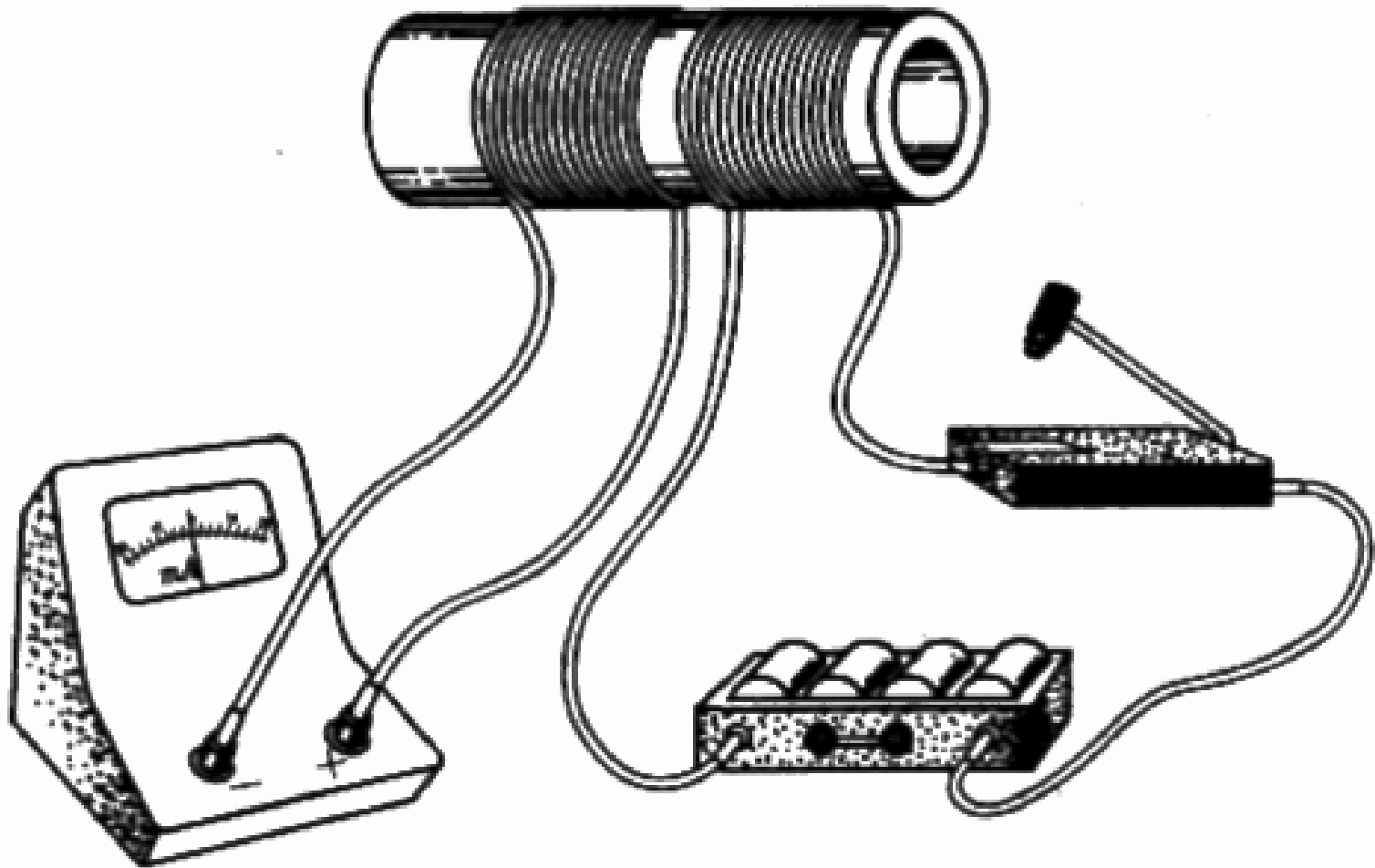

Мал. 2.153

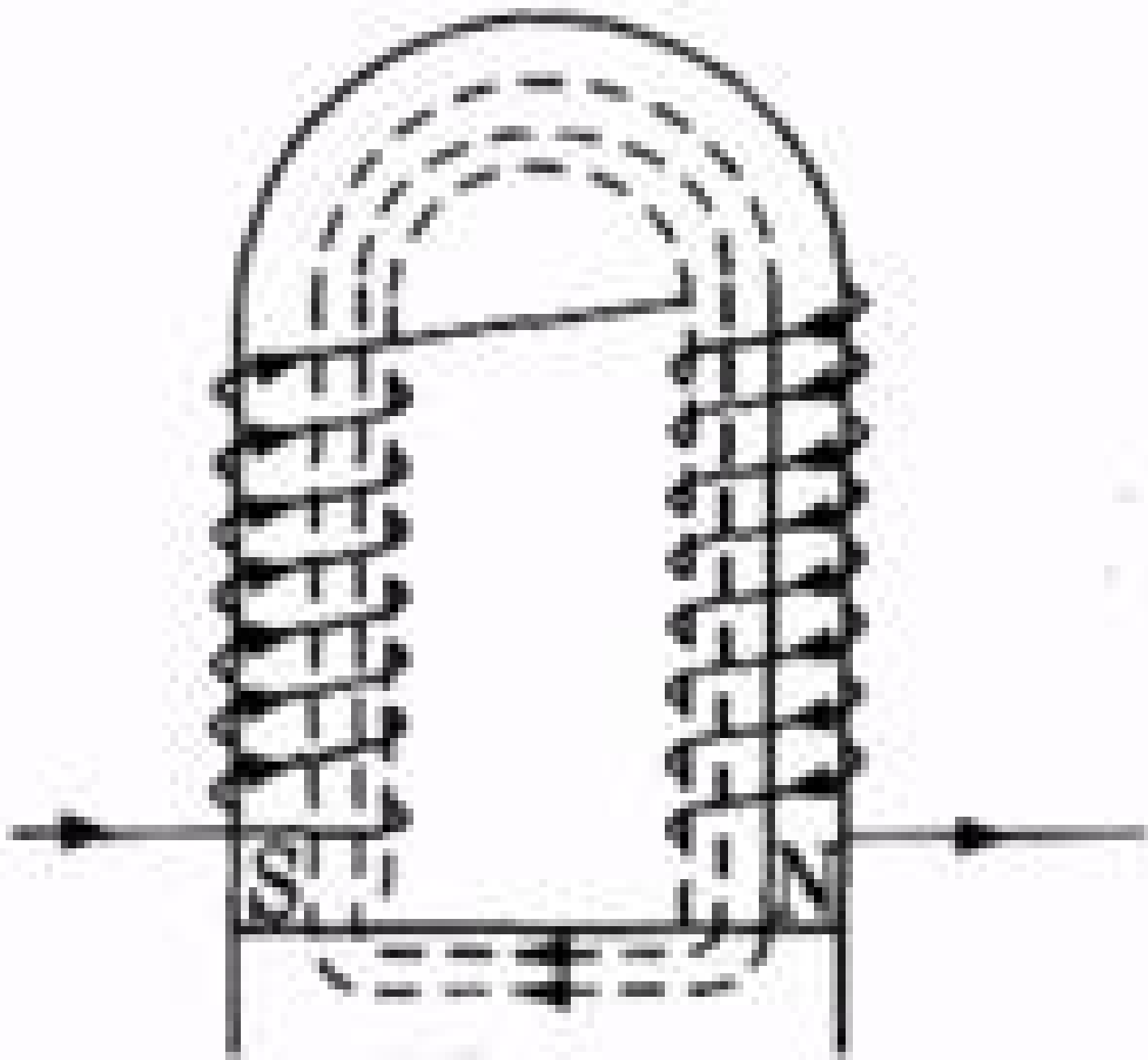

Мал. 2.149

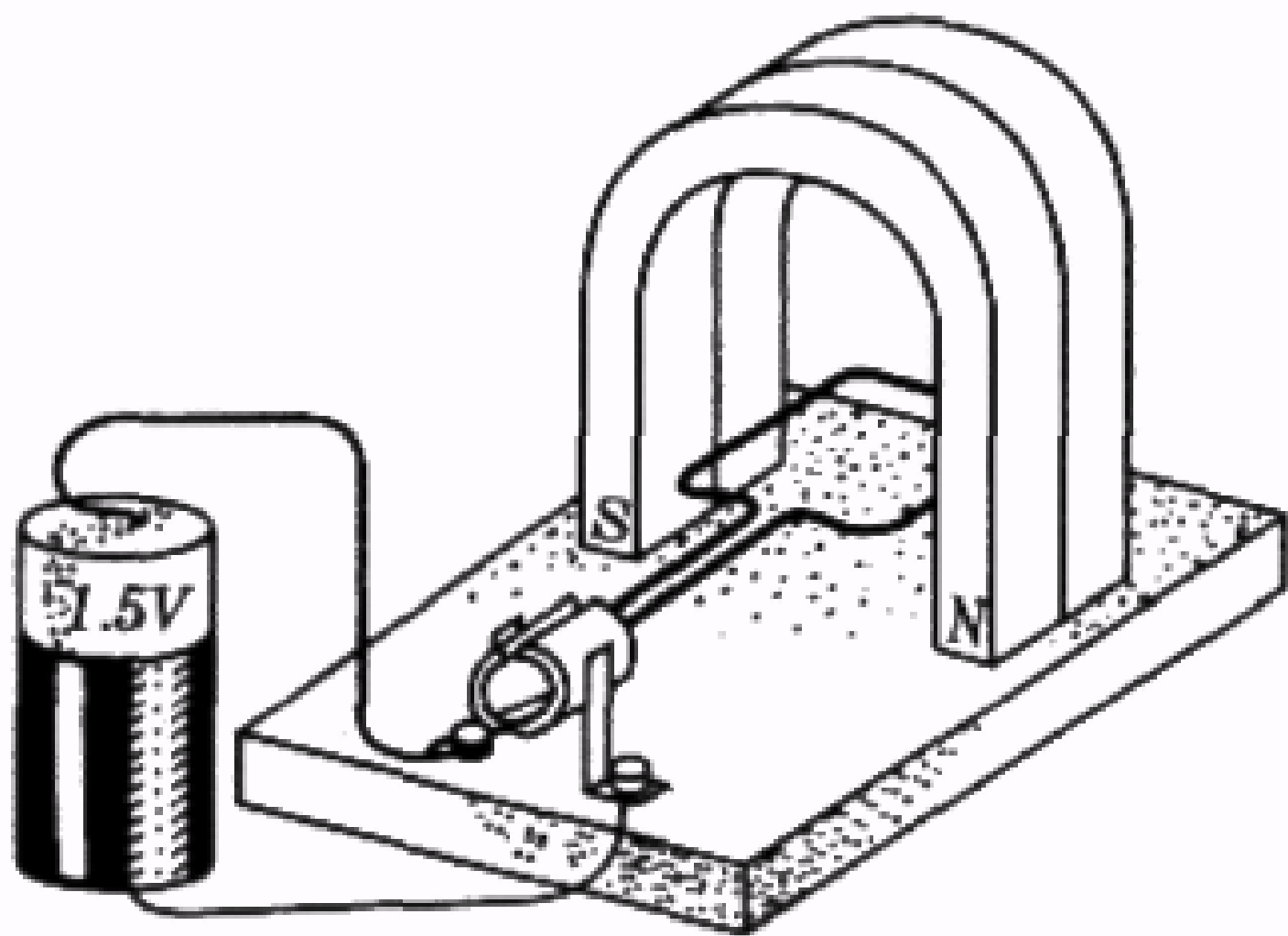

Мал. 2.150

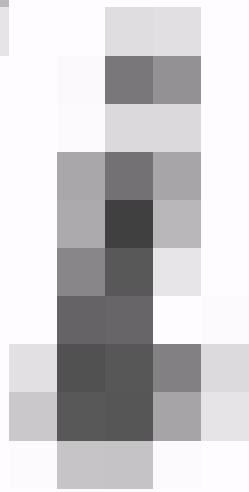

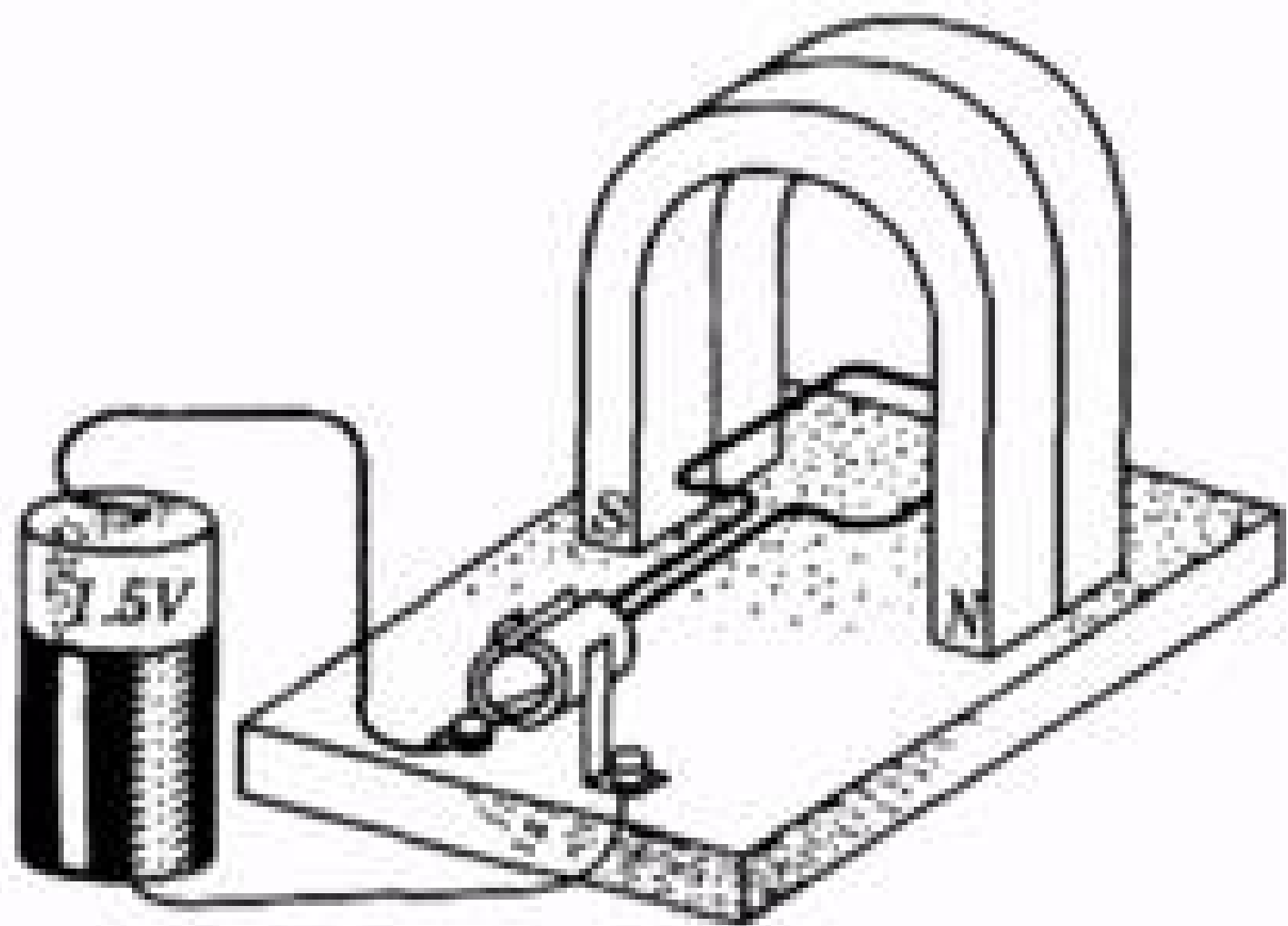

Мал. 2.150

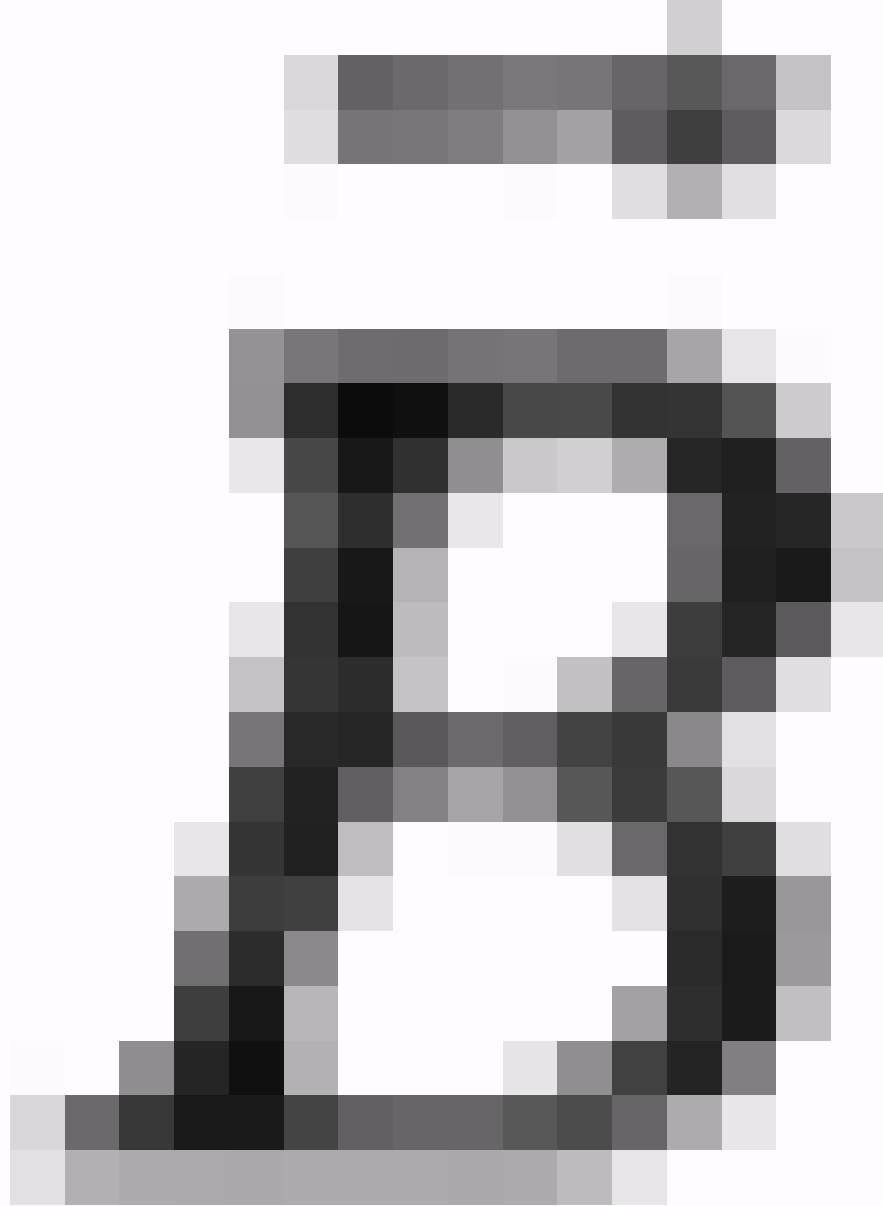

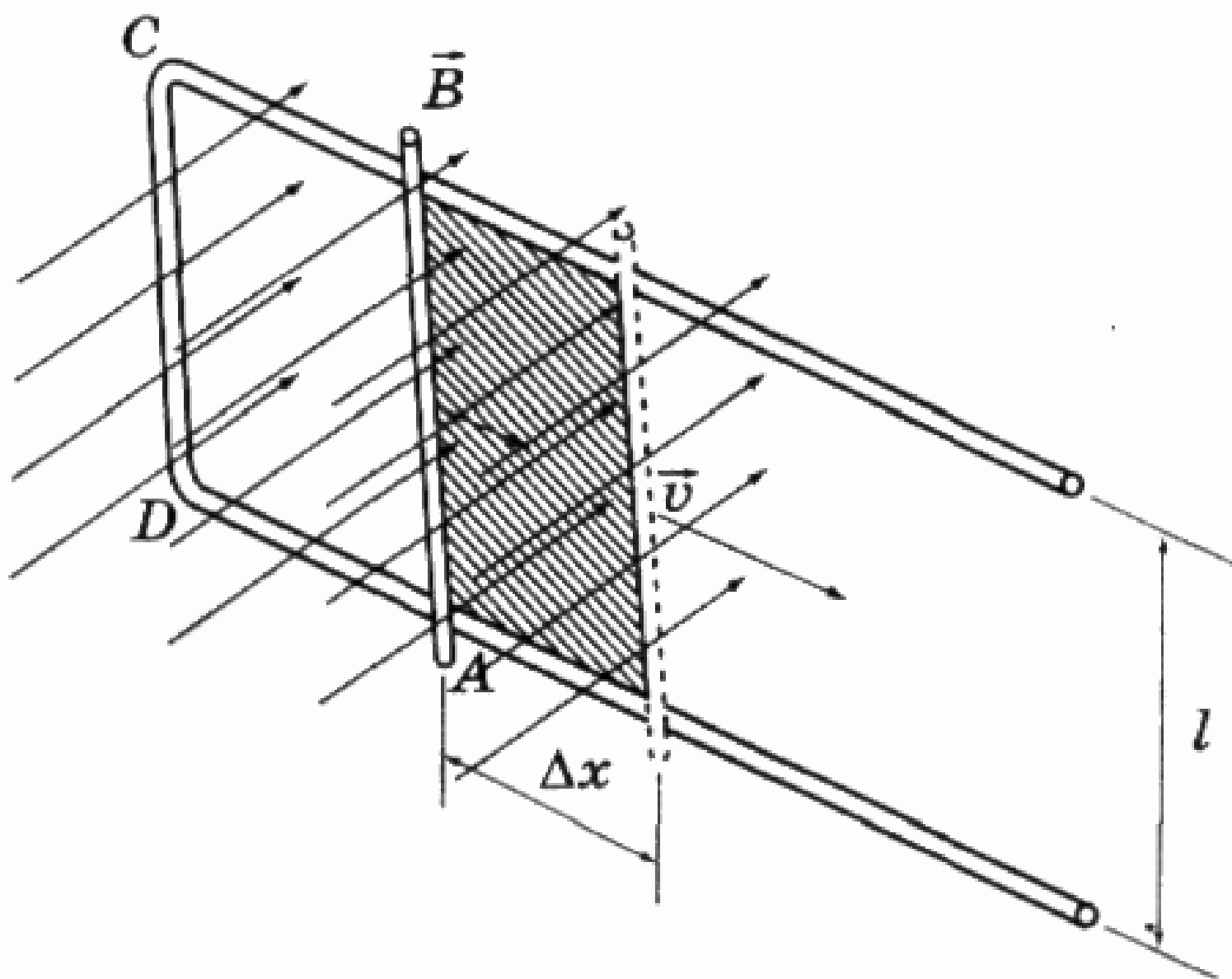

Мал. 2.154

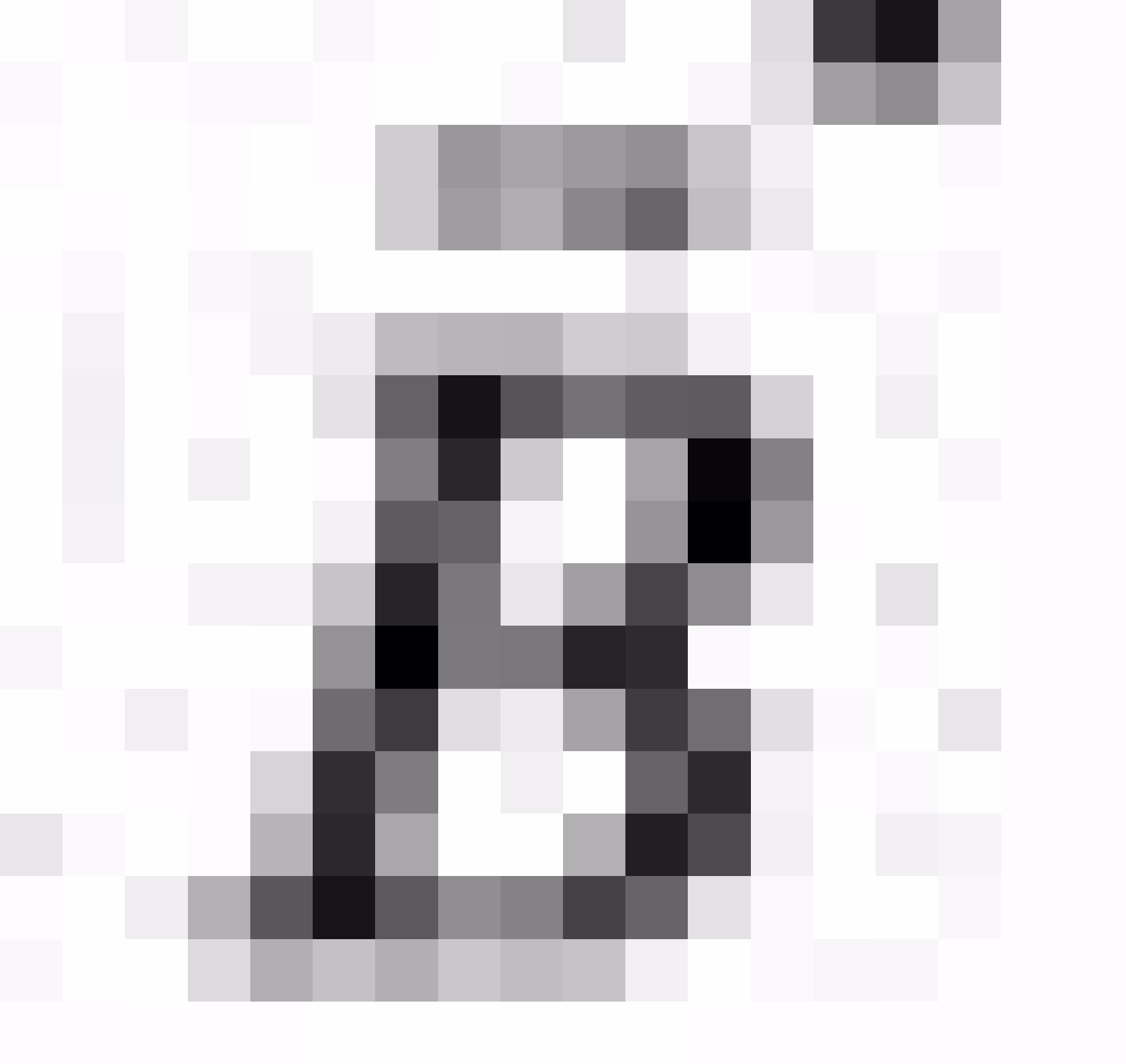

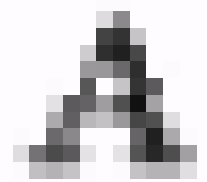
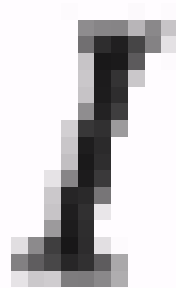
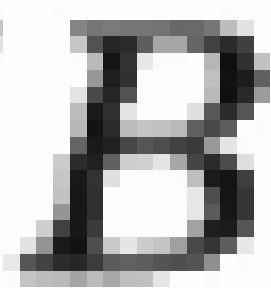
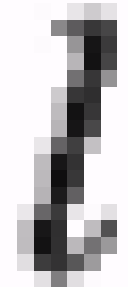
A pixelated, black and white representation of the uppercase letter 'F'. The letter has a thick vertical stem on the left and a horizontal top bar that extends to the right. The right side of the top bar is slightly jagged.A pixelated, black and white representation of the lowercase letter 'a'. It features a vertical stem on the right and a curved bowl on the left that meets the stem at the bottom. The letter is centered vertically relative to the 'F' above it.A pixelated, black and white representation of an equals sign. It consists of two parallel horizontal bars of equal length, one above the other, with a small gap between them.A pixelated, black and white representation of the uppercase letter 'I'. It is a simple vertical bar with a slightly wider base and top, and a small hook at the top right corner.A pixelated, black and white representation of the uppercase letter 'B'. It has a vertical stem on the left and two rounded bowls on the right, one above the other. The letter is centered vertically relative to the 'I' above it.A pixelated, black and white representation of the lowercase letter 'l'. It is a simple vertical bar with a slightly wider base and top, and a small hook at the top right corner. It is centered vertically relative to the 'B' above it.A pixelated, black and white representation of a period (dot). It is a small, solid black square centered vertically relative to the 'l' above it.



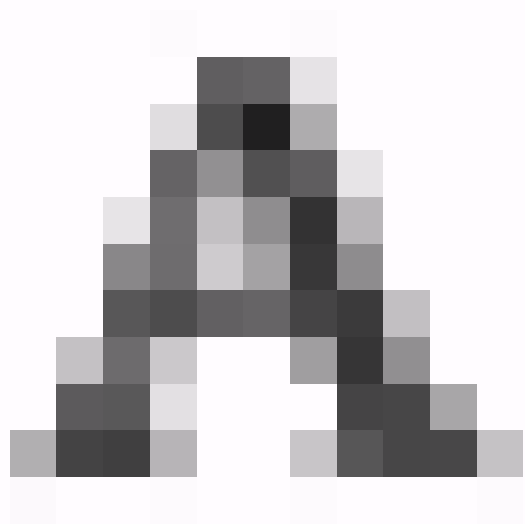
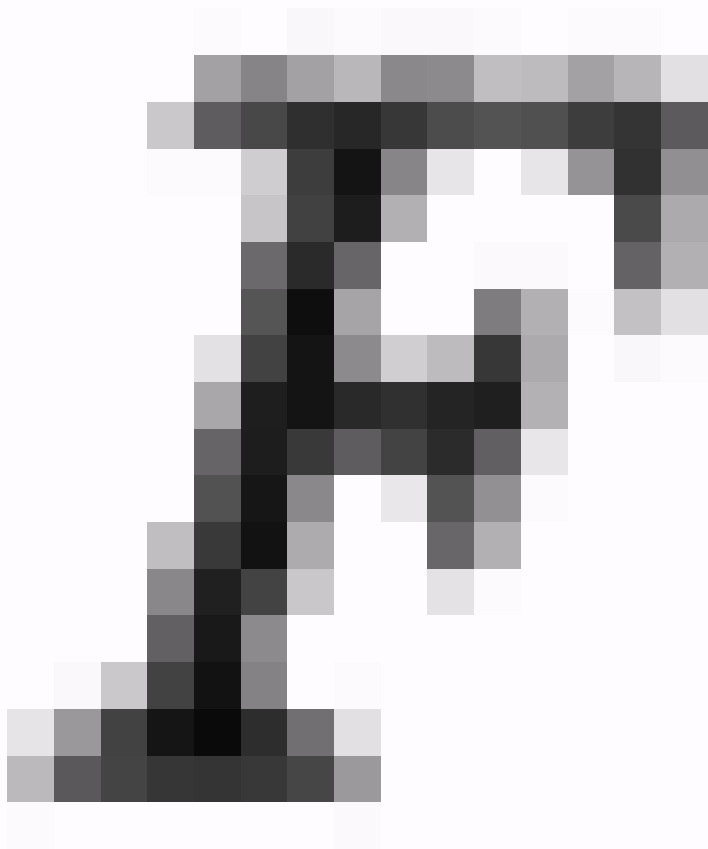



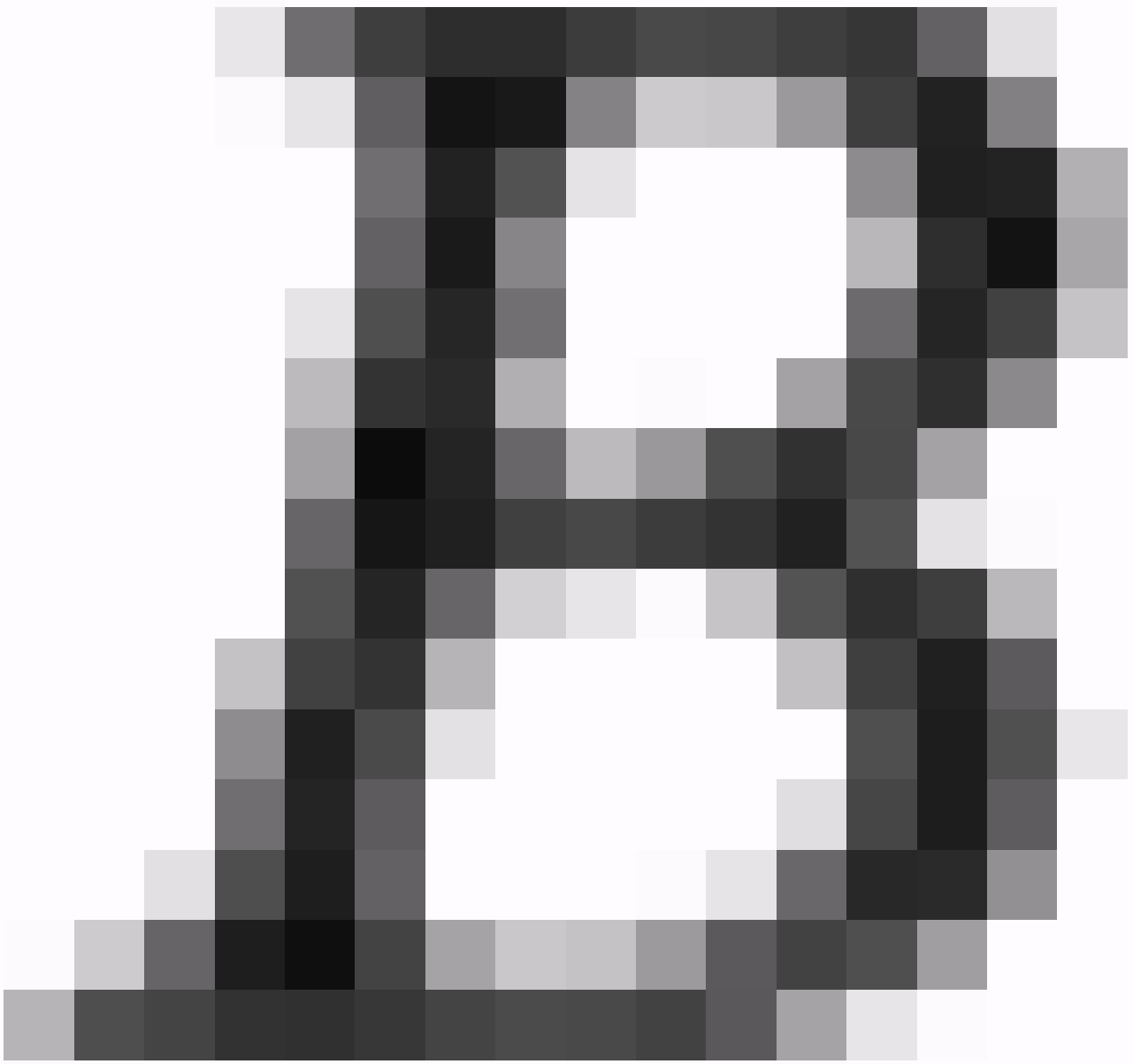

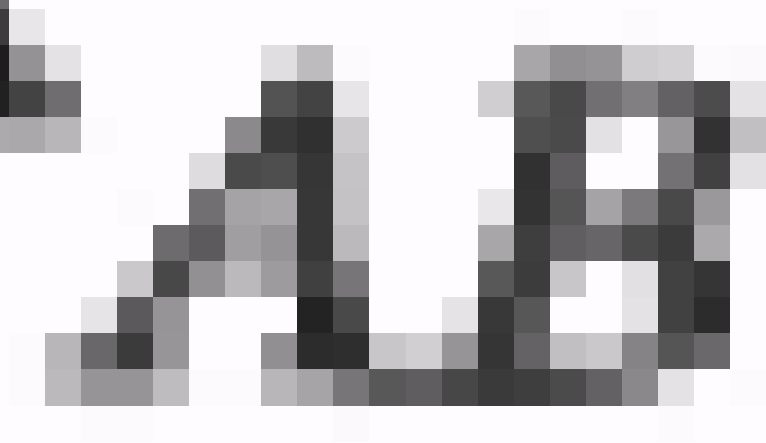
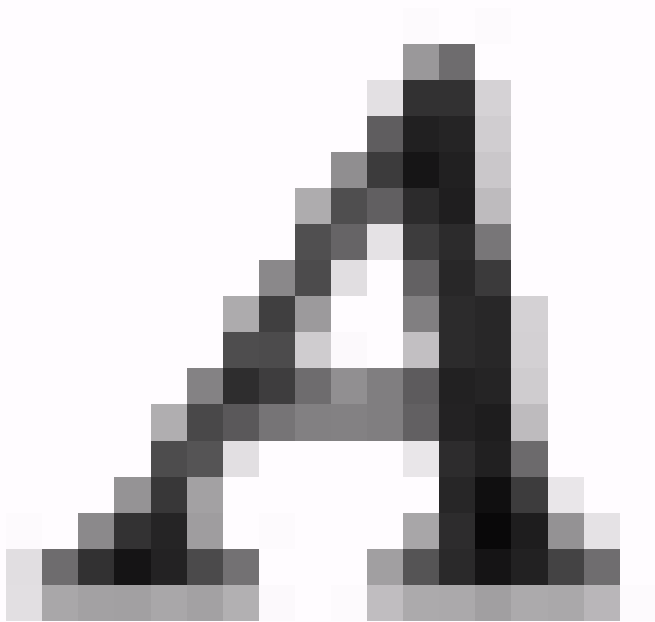

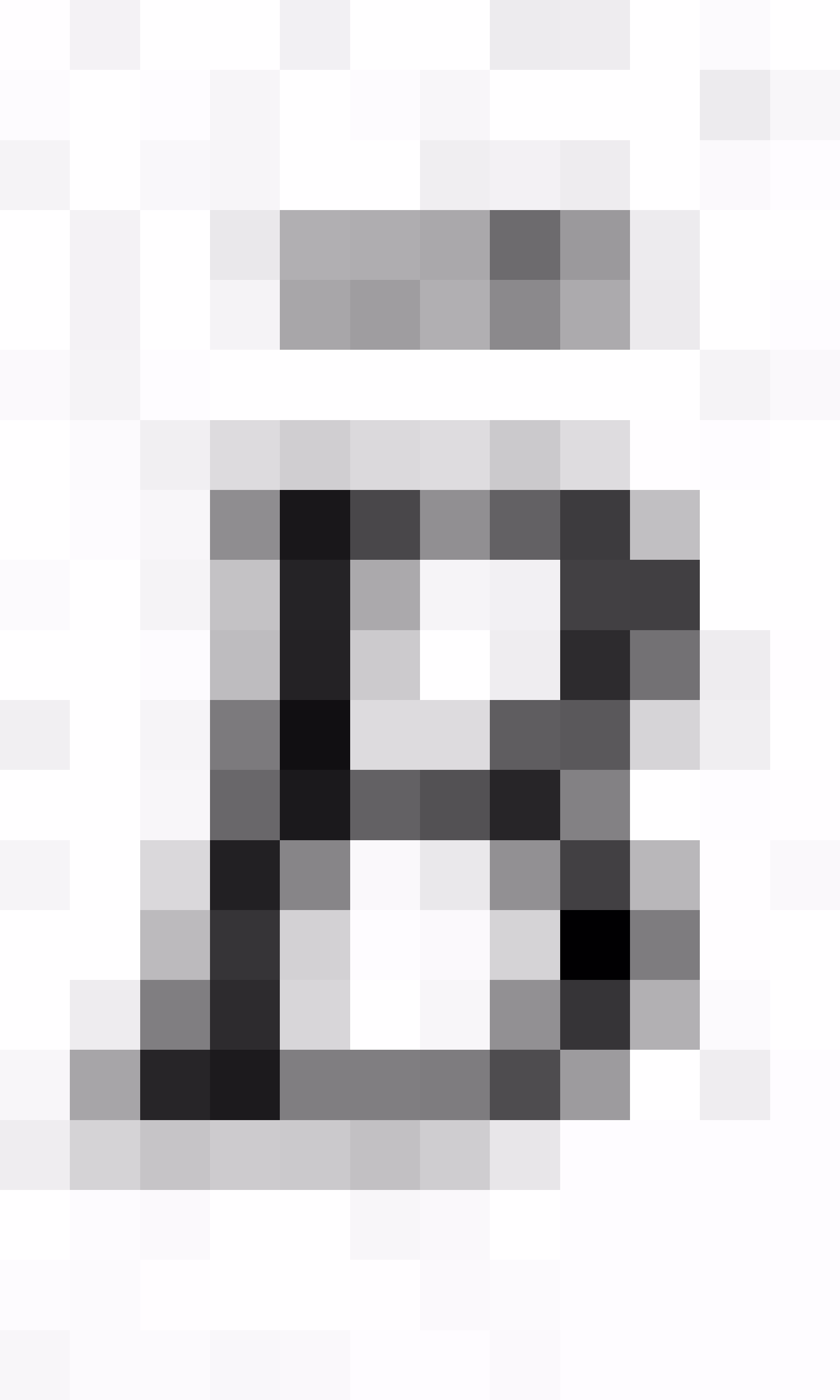

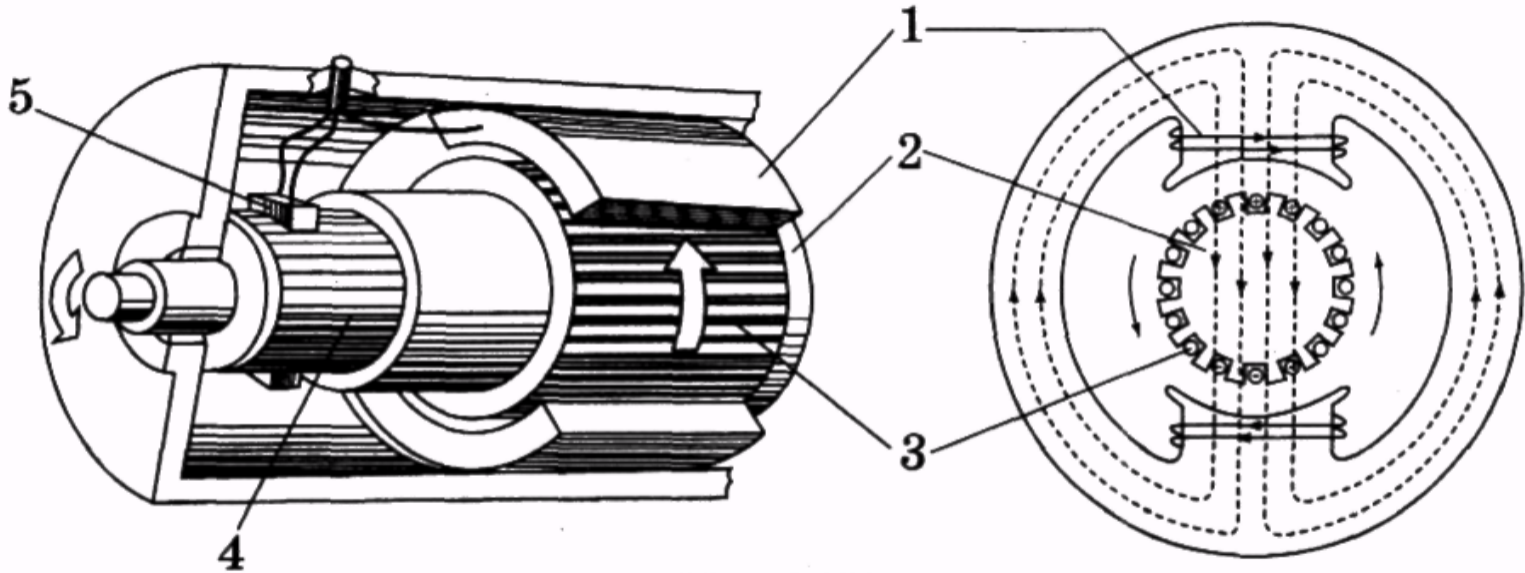

Мал. 2.151

$$A = AB \quad = \quad eVB1 \quad = \quad (40.9)$$

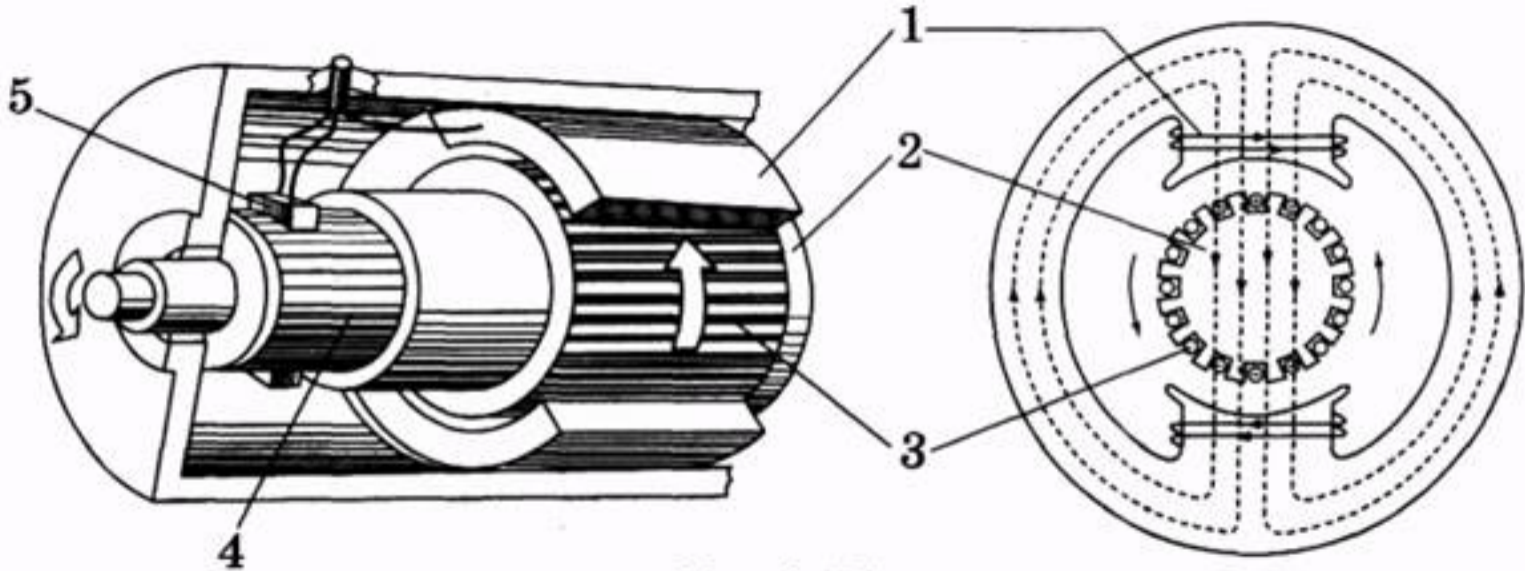

Мал. 2.151

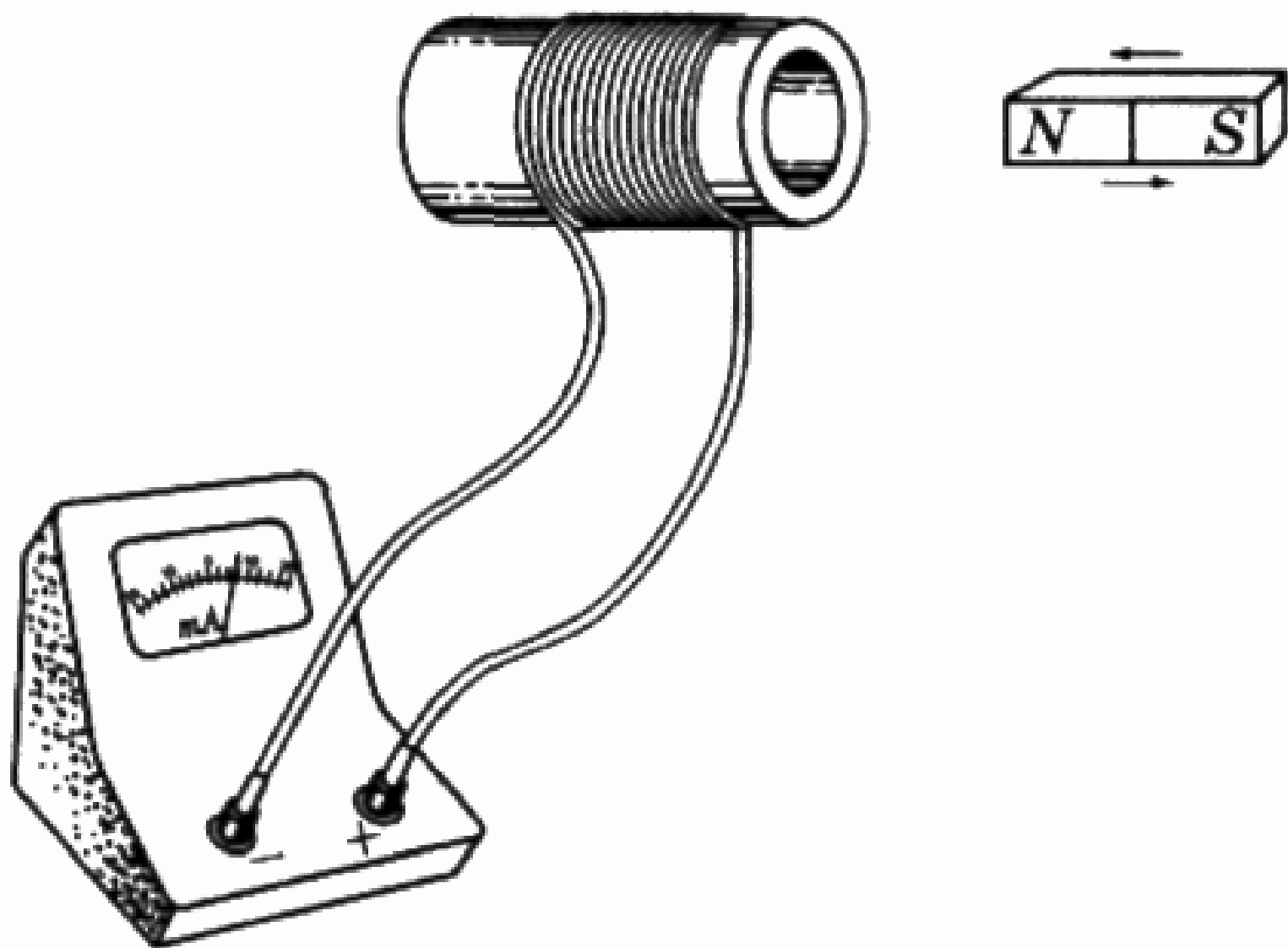

Мал. 2.152

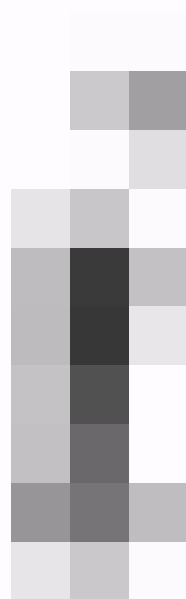
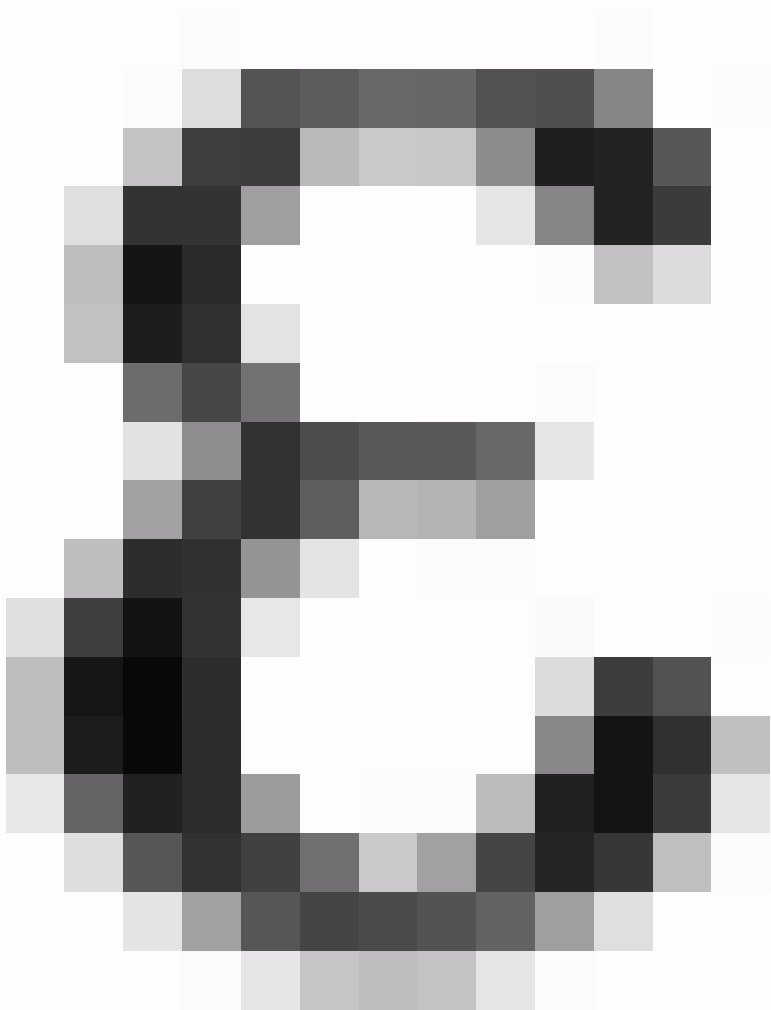

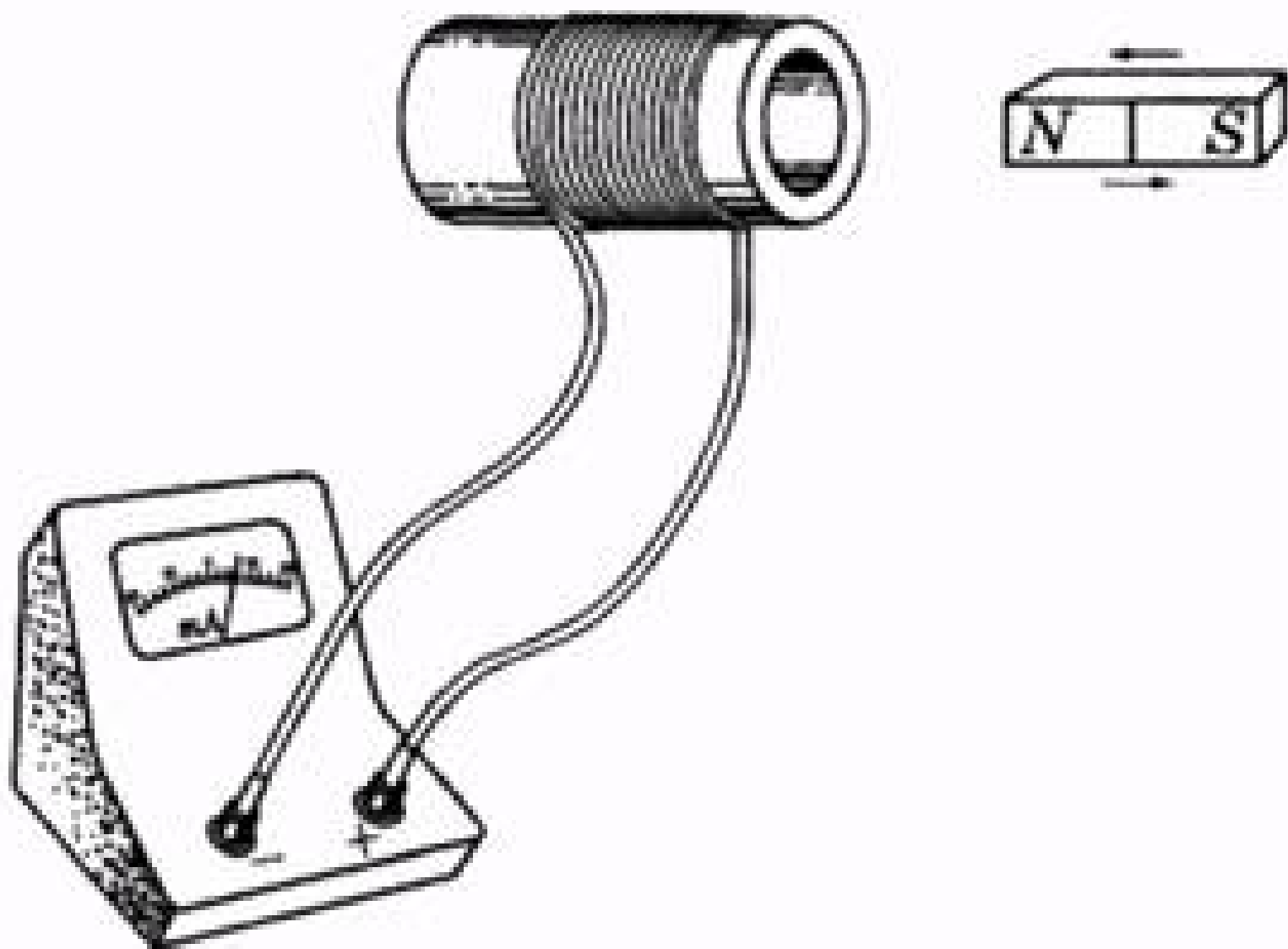

Мал. 2.152

$$E_1 = \frac{A}{e} = vBl \quad (40.4)$$

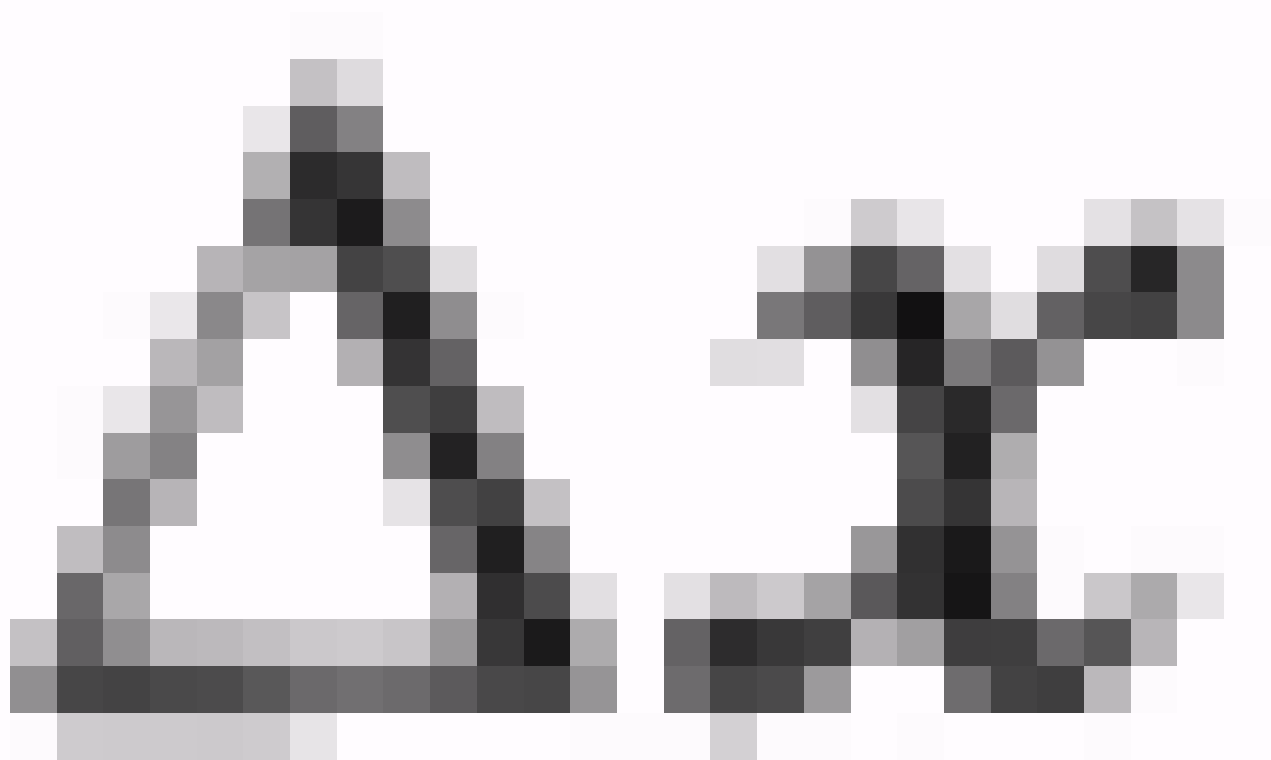

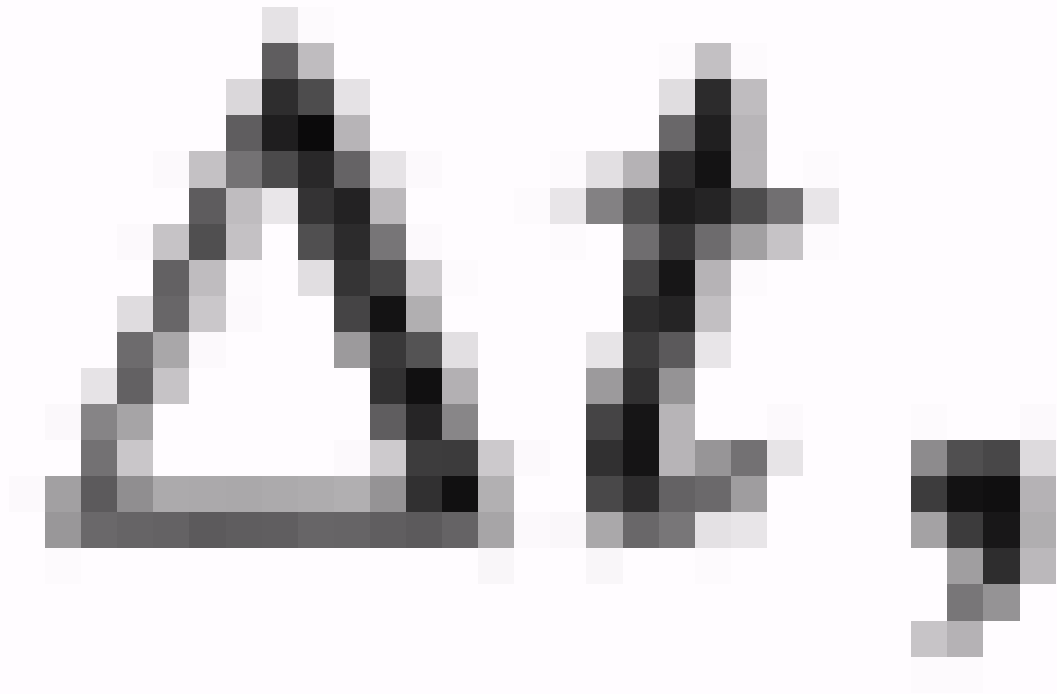

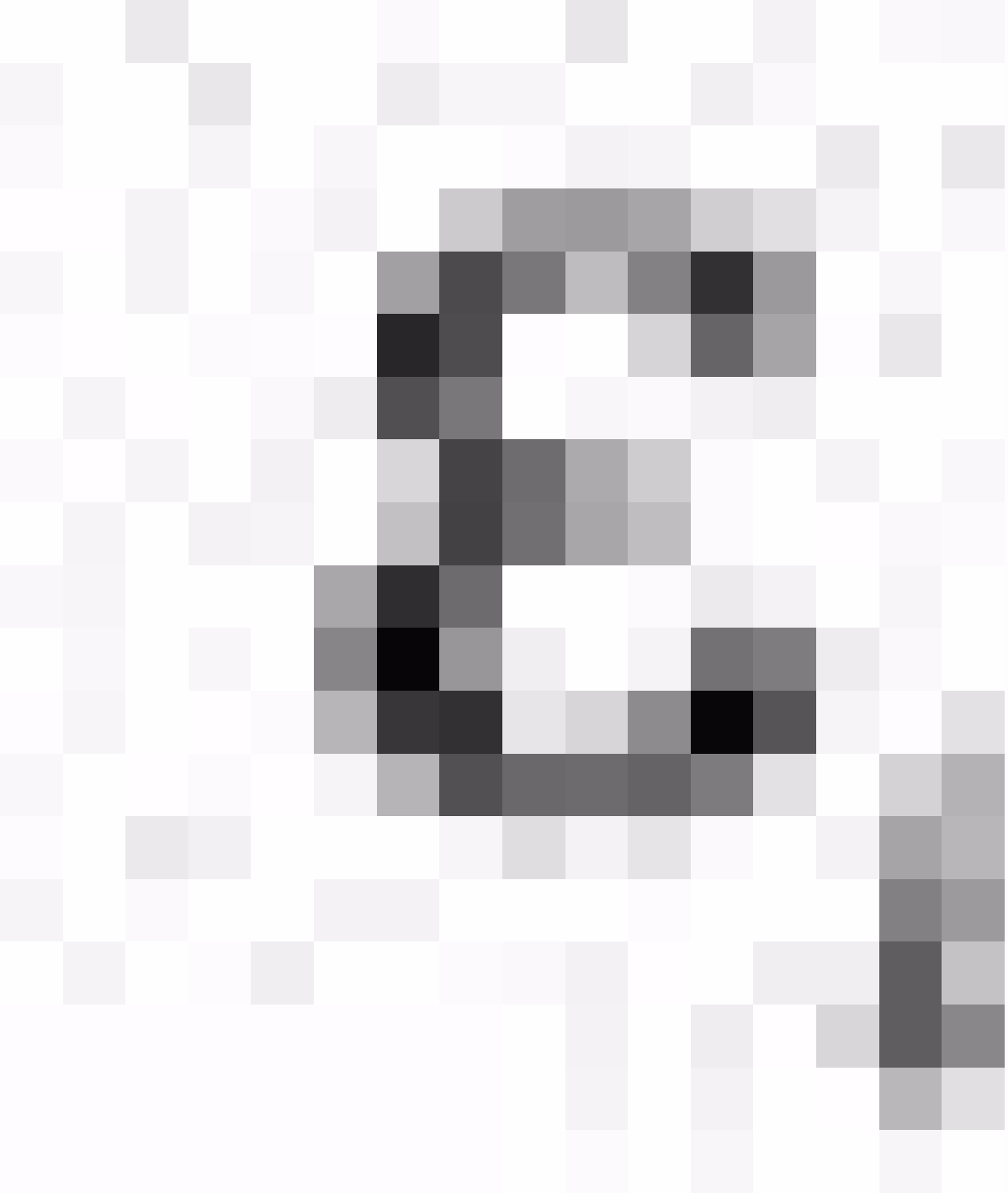

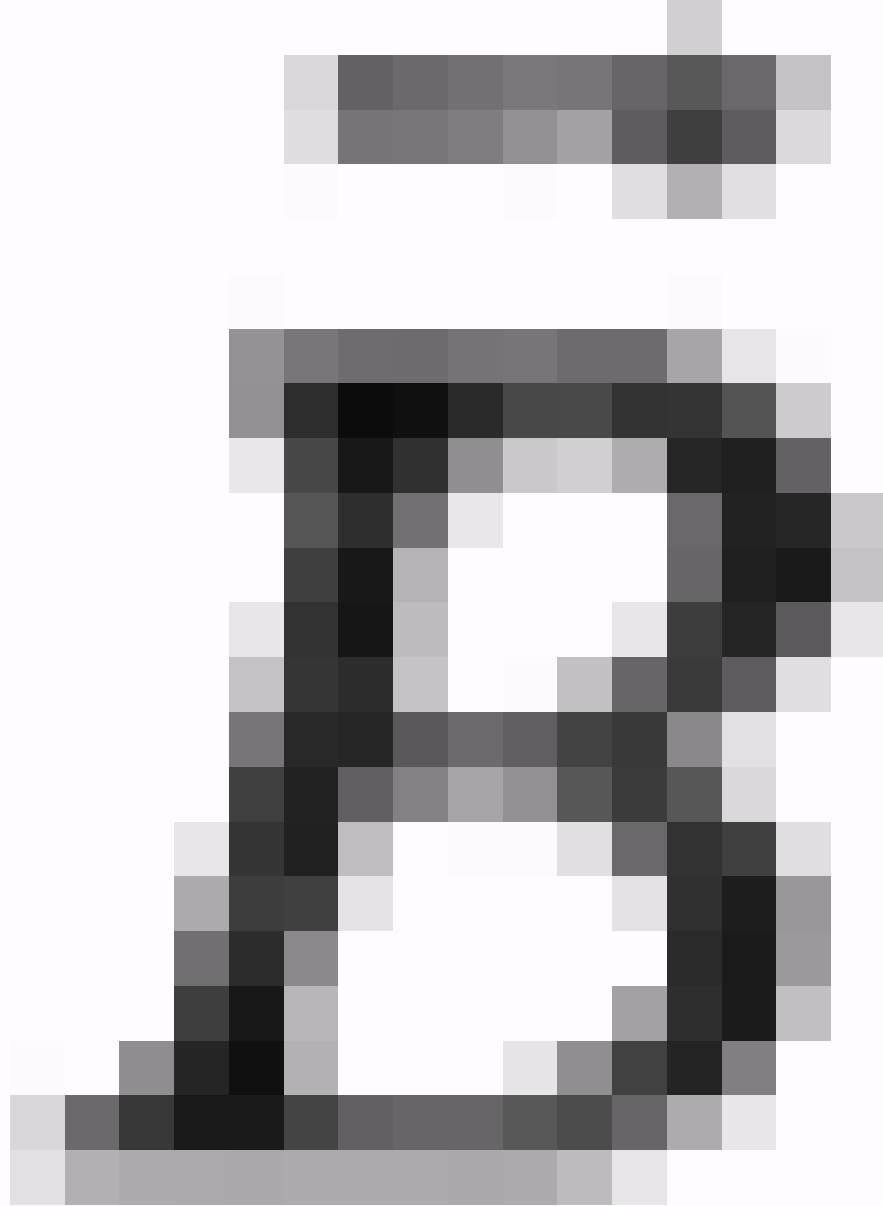

$$v \equiv \frac{\Delta x}{\Delta t}$$

(46.5)

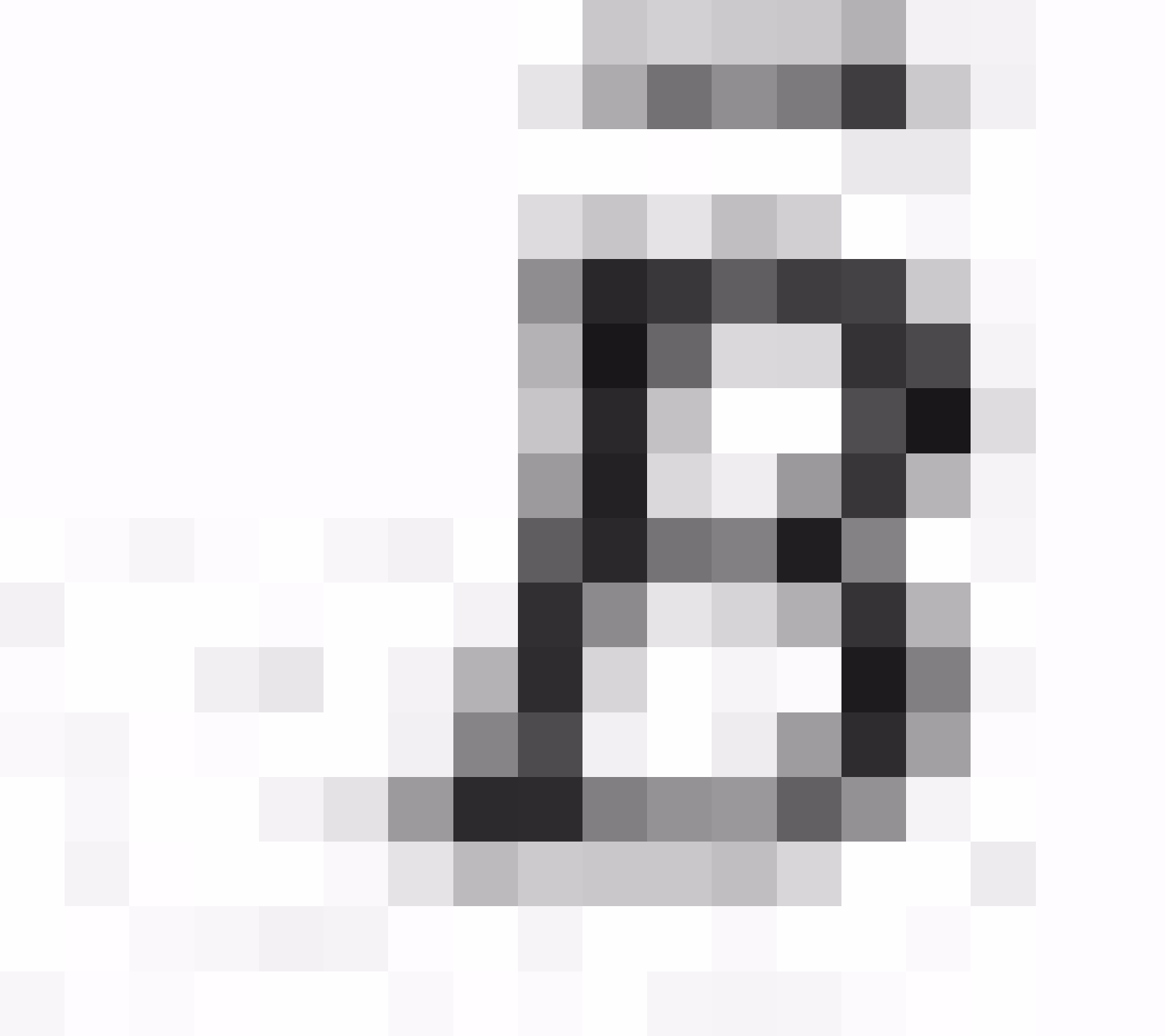

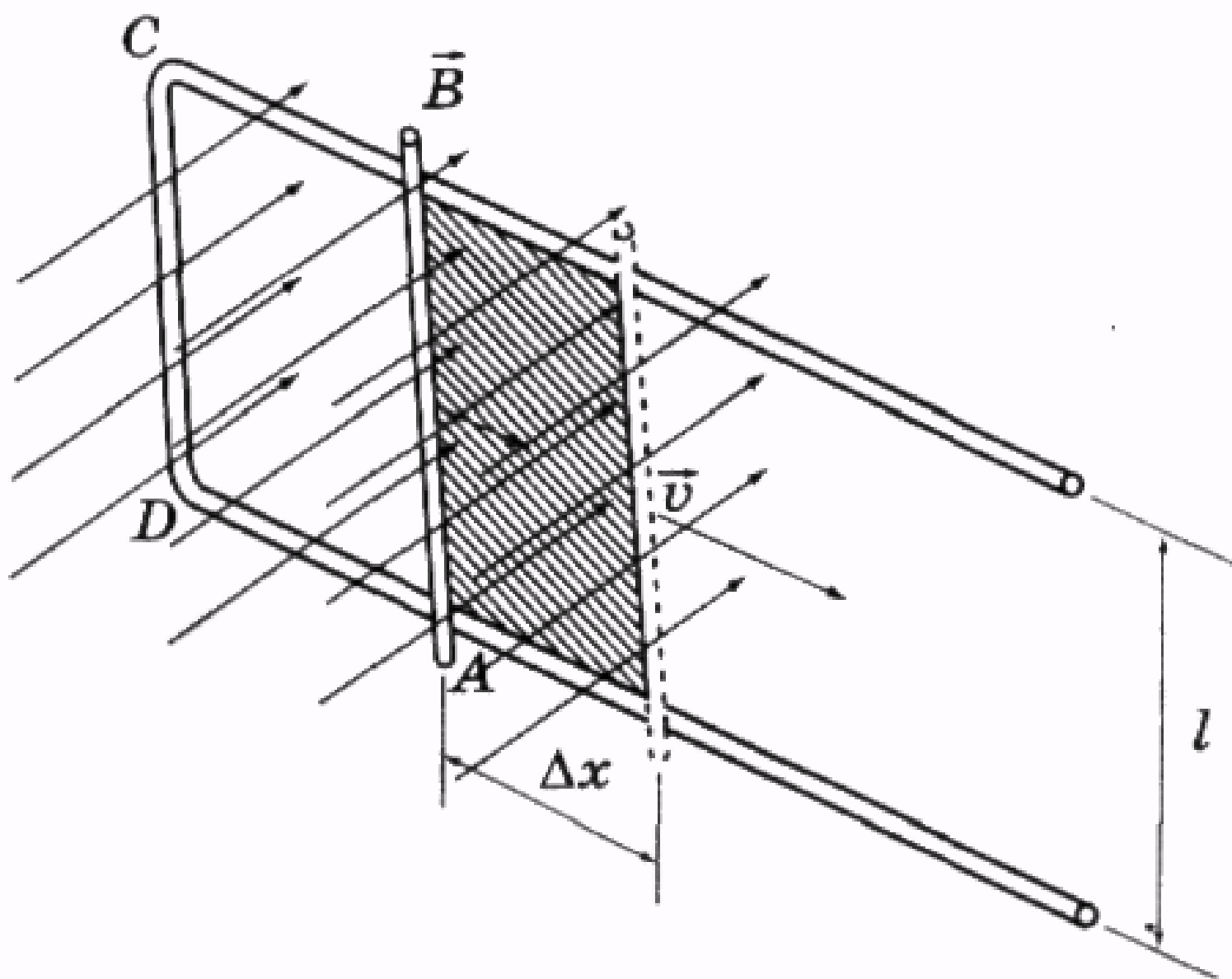

Мал. 2.154

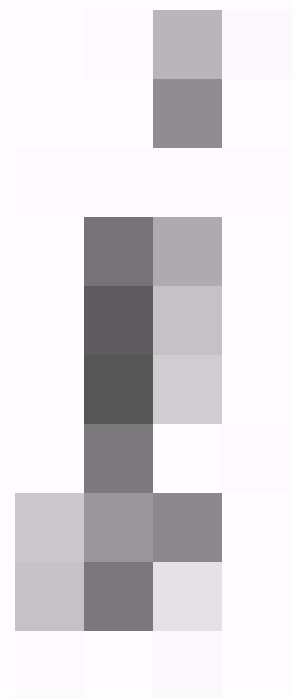
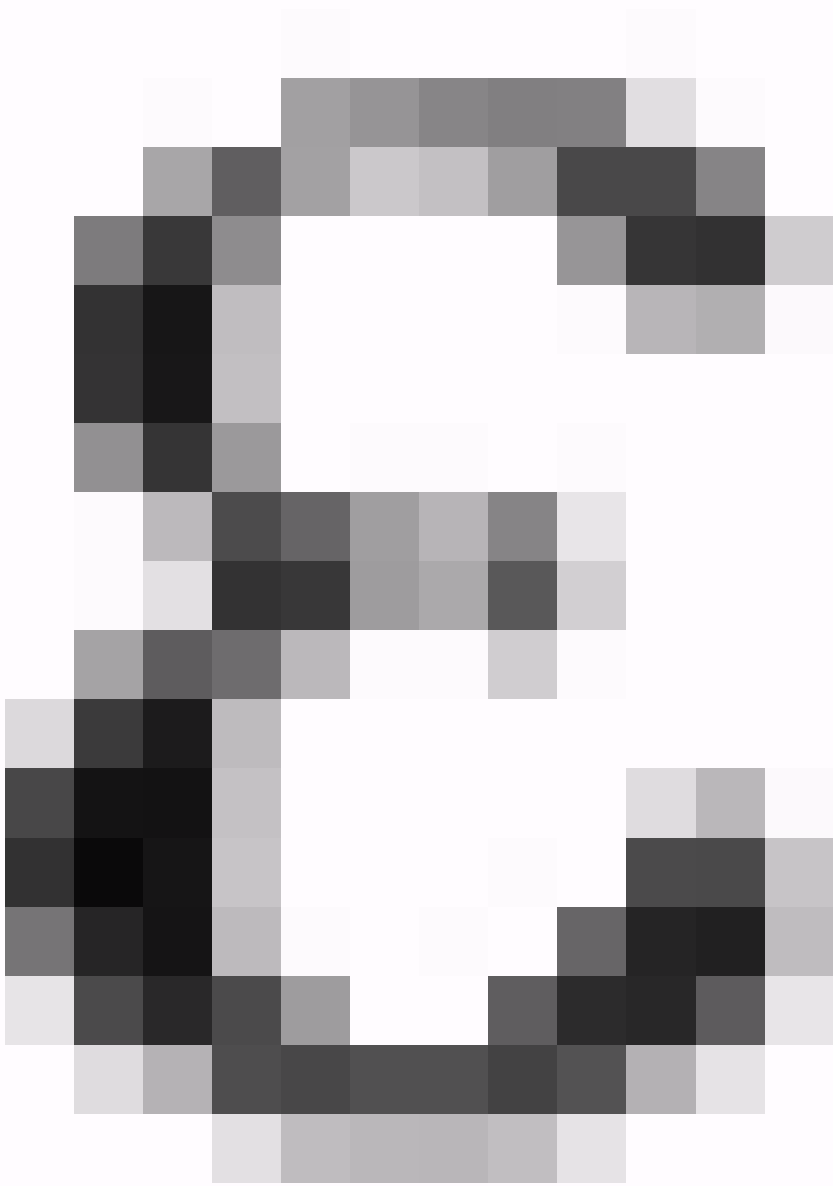

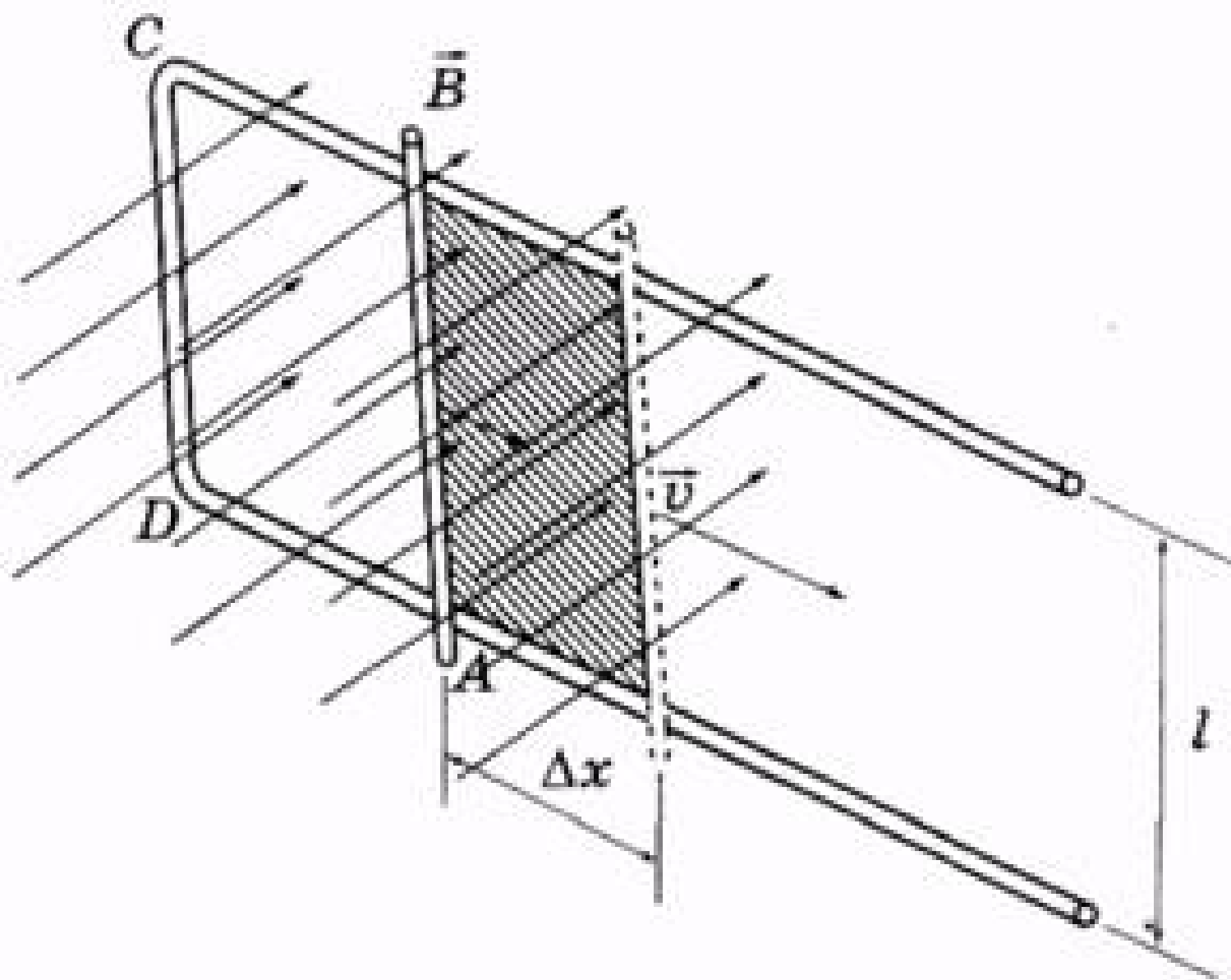

Мал. 2.154

11

=

evB

11

$$\epsilon_t = v_t B_t = \frac{B_t \Delta x_t}{\Delta t} = \frac{B_t \Delta S}{\Delta t} \quad (46.6)$$



$$A_{AB} = P_{AB} = e^{v_{AB}} \quad (46.2)$$



1947-1948

1949-1950

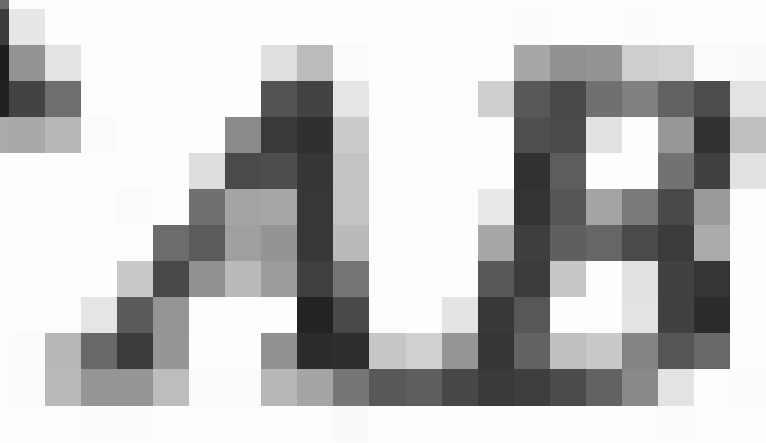
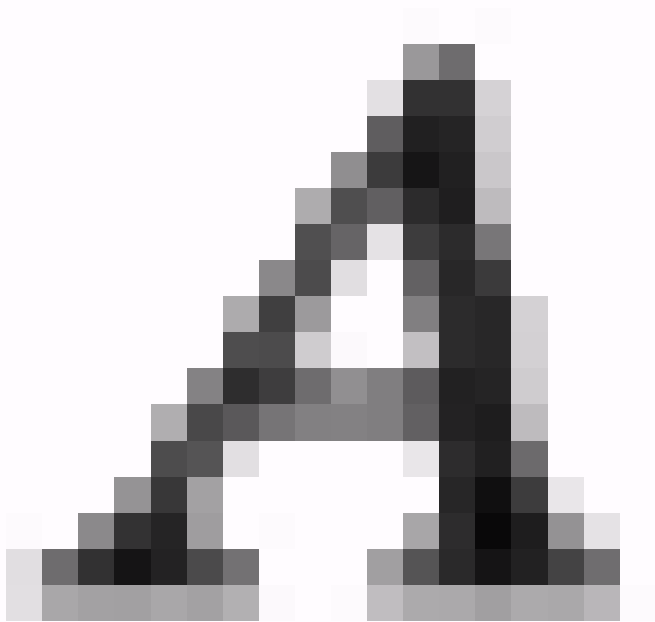

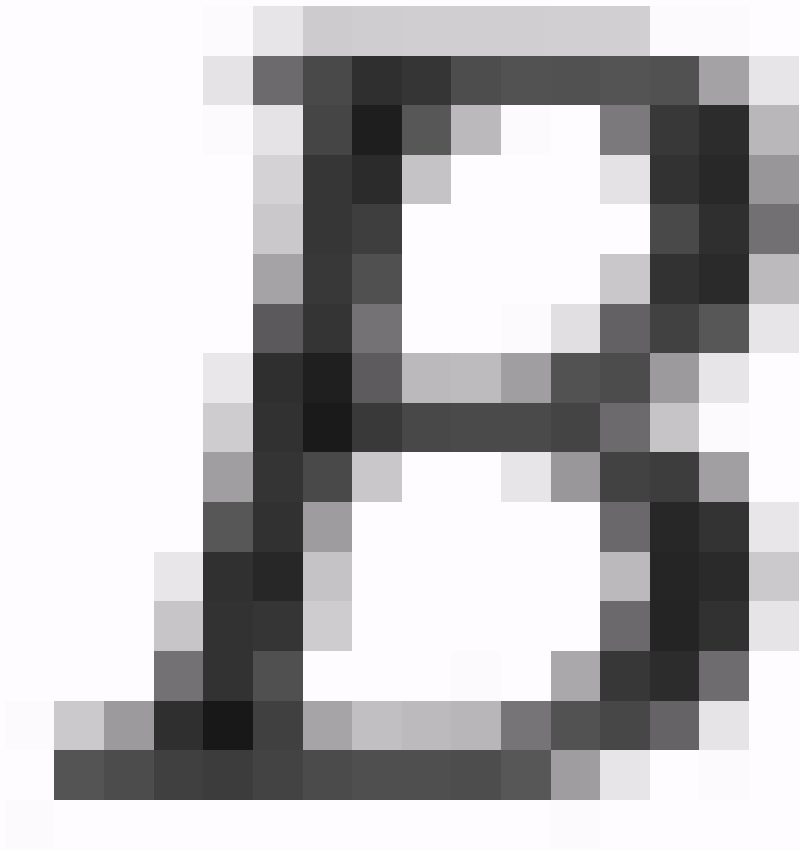
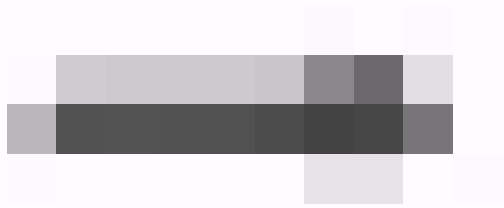



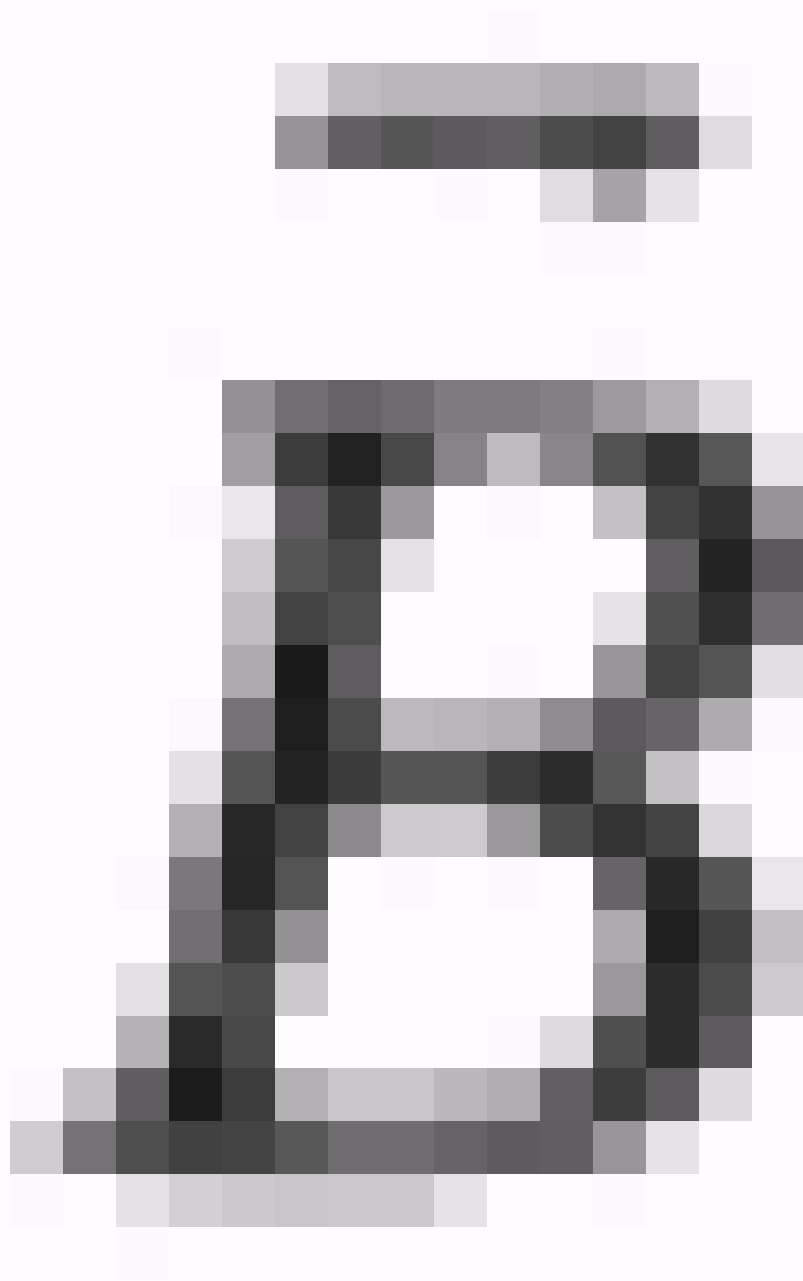

$$\Phi = BS \quad (46.7),$$

$$1B6 = 1\pi \cdot 1M^2.$$

$$|\epsilon_i| = \frac{|BAS|}{\Delta t} = \left| \frac{\Delta \Phi}{\Delta t} \right| \quad (46.8).$$

$$\varepsilon_i = \frac{\Delta \Phi}{\Delta t} \quad (46.9)$$

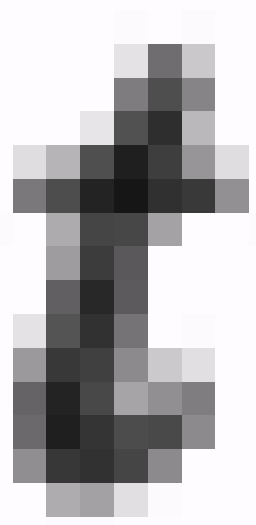
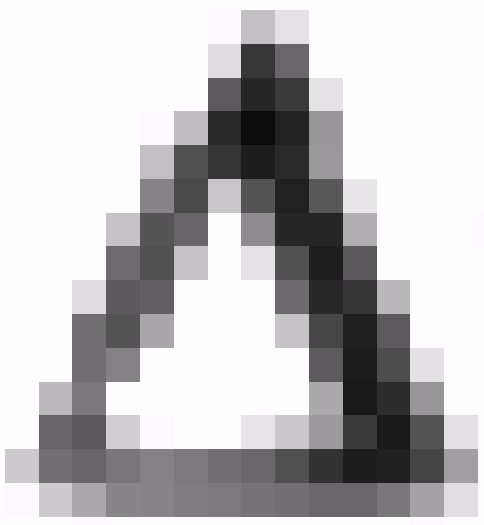
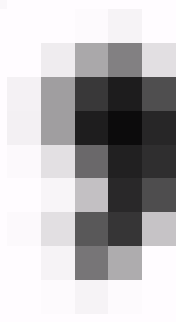
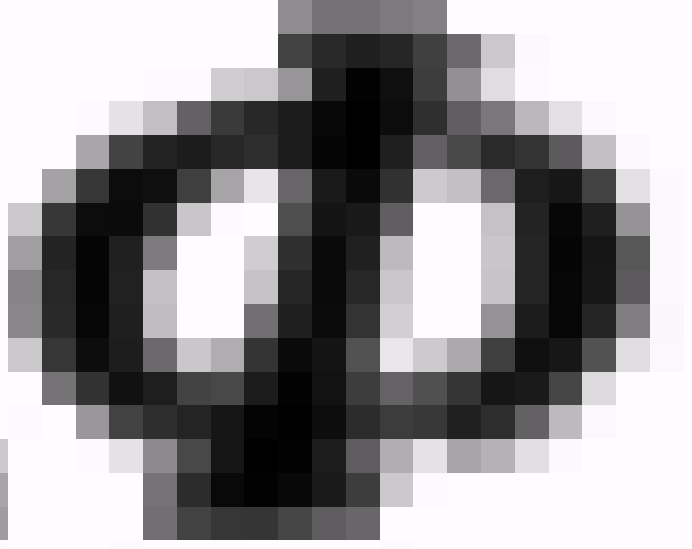
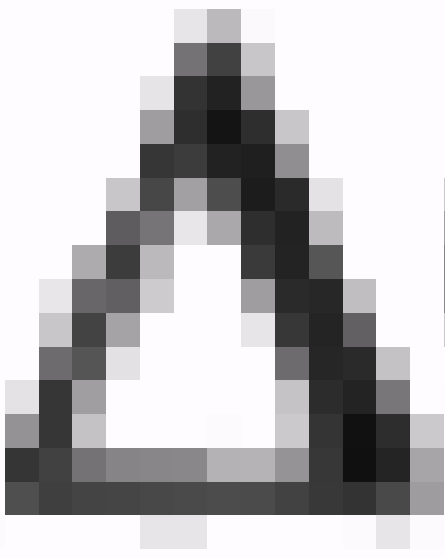

$$E_t = -n \frac{\Delta \Phi}{\Delta t}$$

(46.10)



$\mathbb{L} = \frac{\Phi}{I}$

$\mathbb{I} \mathbb{H} = \frac{1 \text{ B6}}{1 \text{ A}}$

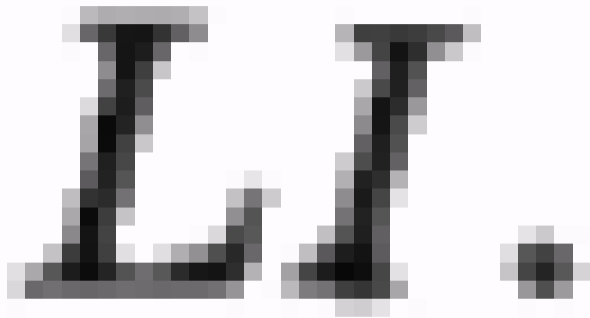
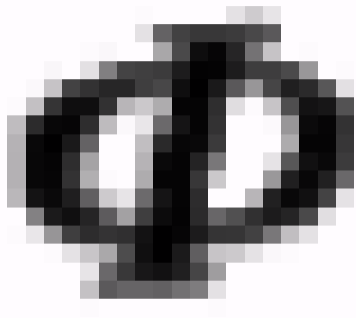

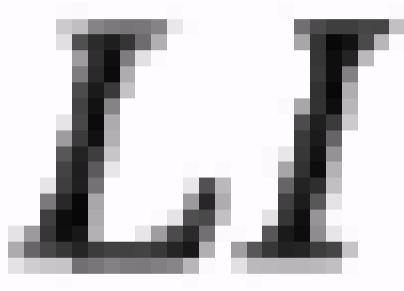
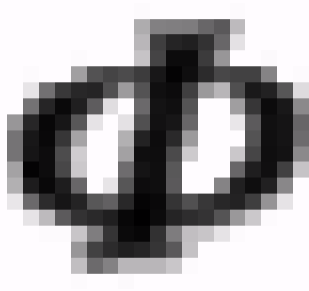

$$\mathcal{E}_W = - \frac{\Delta \Phi}{\Delta t} = - \mathcal{L} \frac{\Delta V}{\Delta t} \quad (47.2)$$

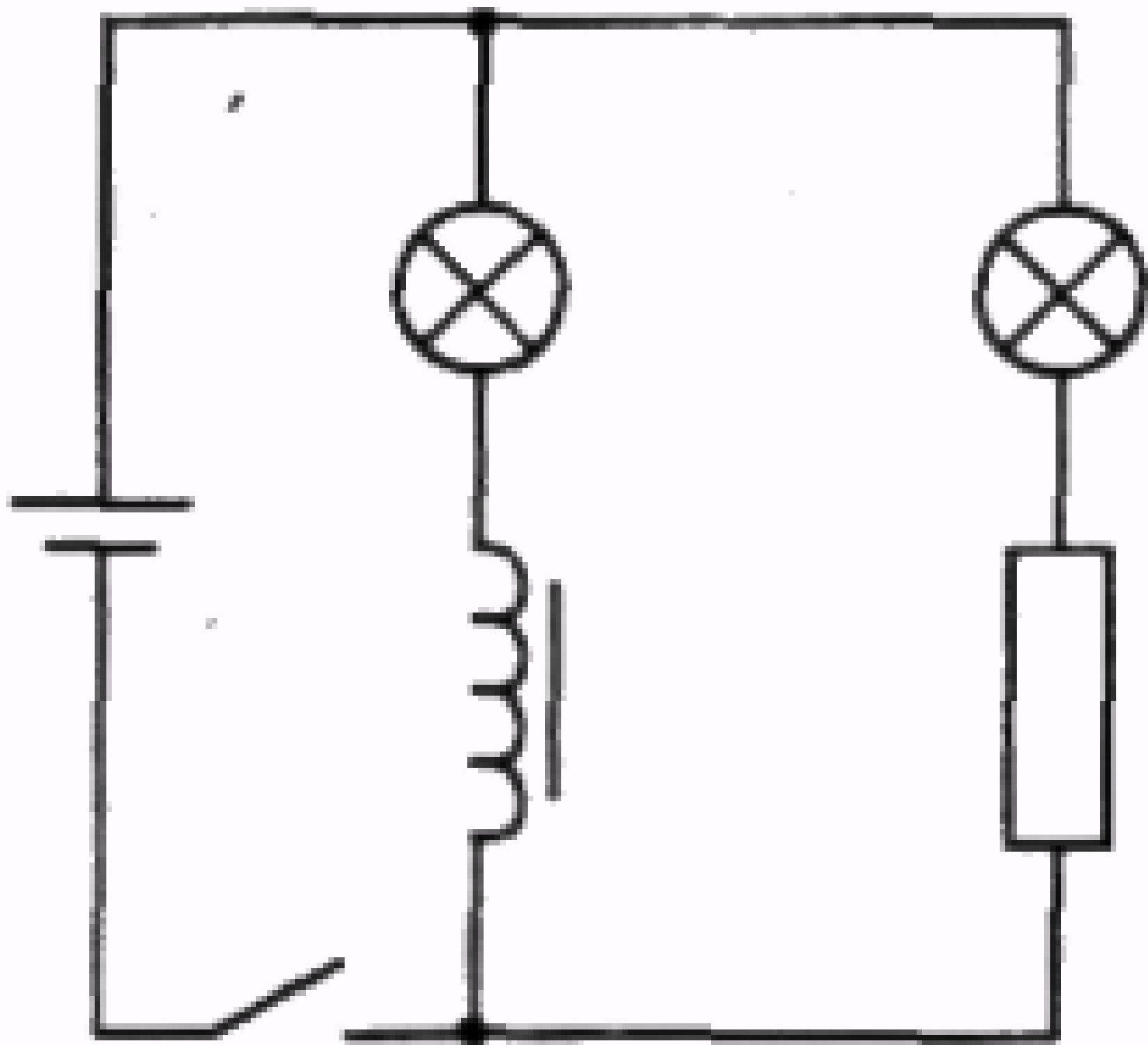

Мал. 2.155

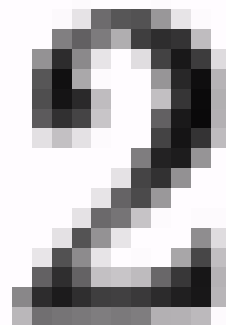
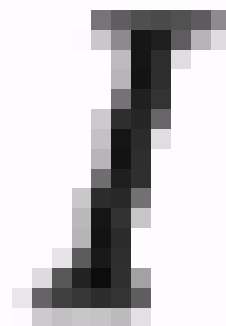
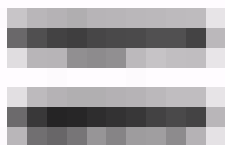
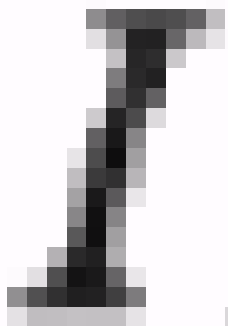

$$Q = \frac{1}{c} \frac{d}{dt} \left(\frac{1}{2} \right) = \frac{1}{2c}$$

$$A = qE_w = \frac{I_t}{2} + \frac{I_{II}}{2} = \frac{I_{II}^2}{2}$$

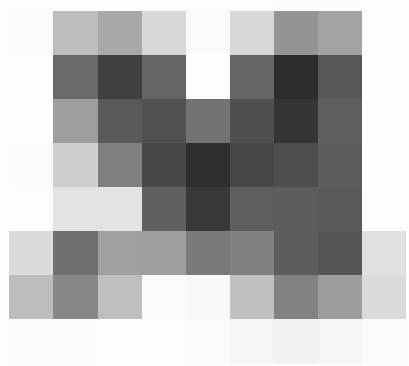
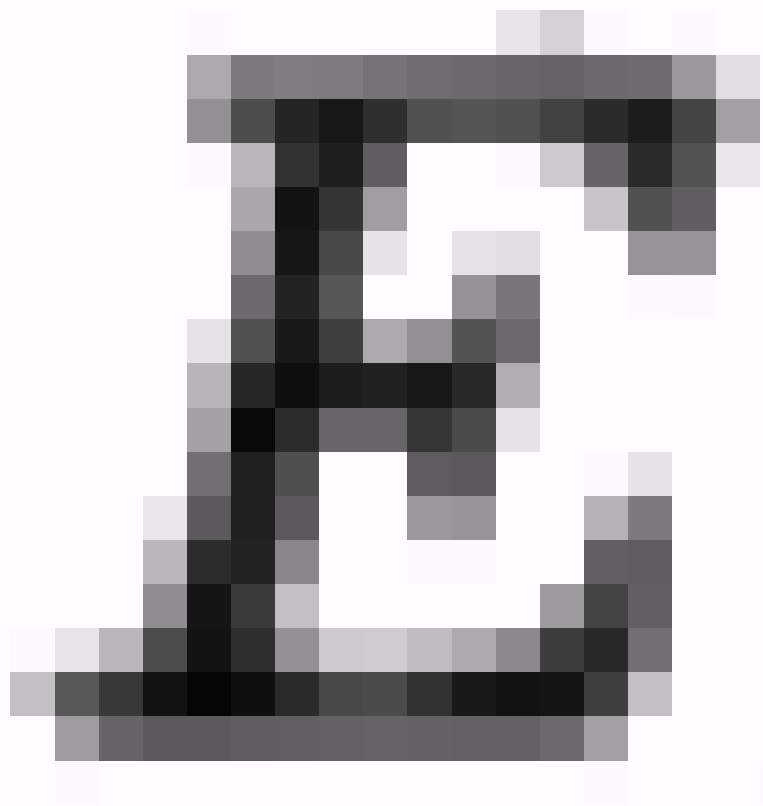

$$E_N = \frac{L_1^2}{2}$$

(47.3)



Мал. 2.156

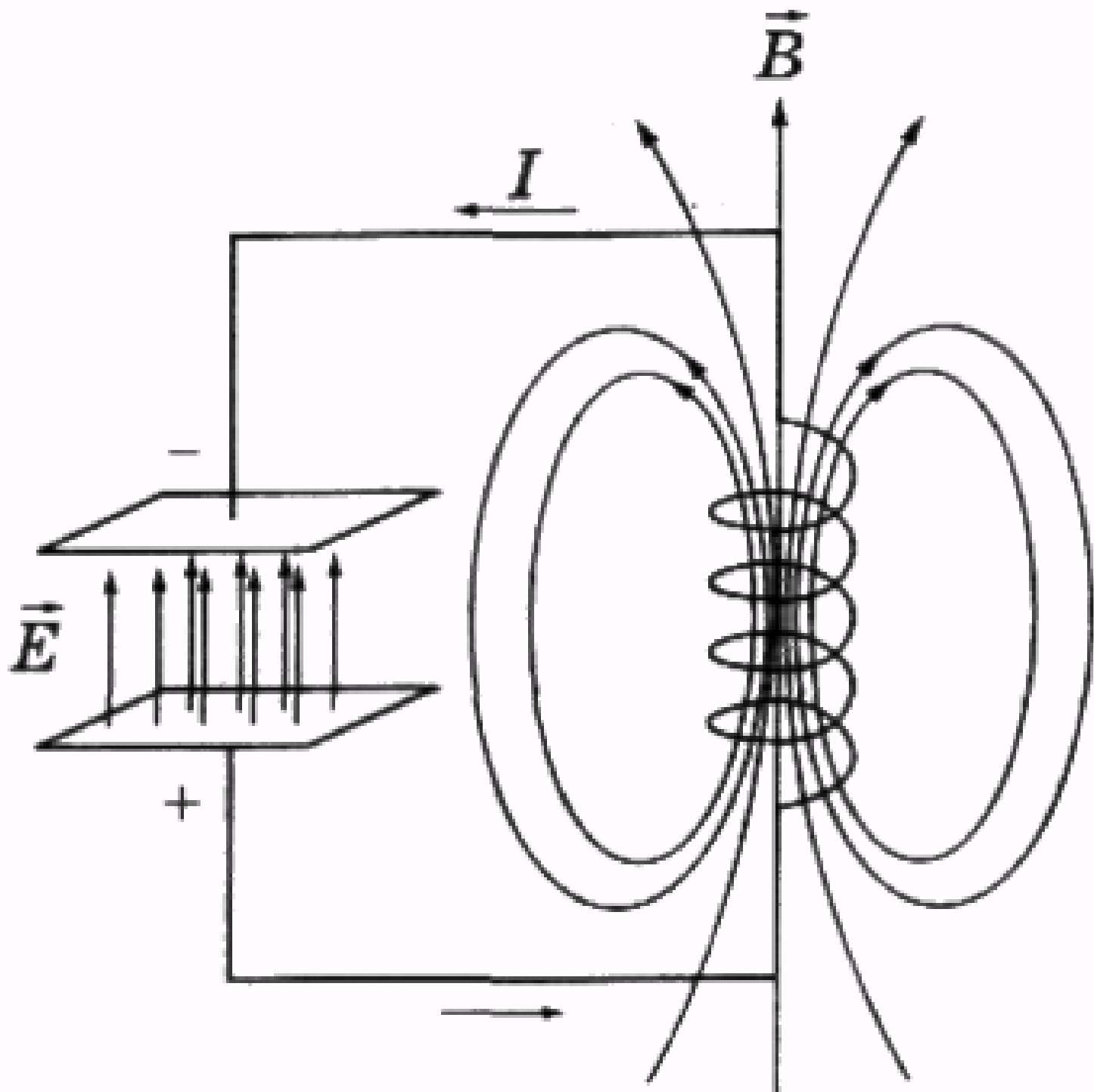

Мал. 2.157

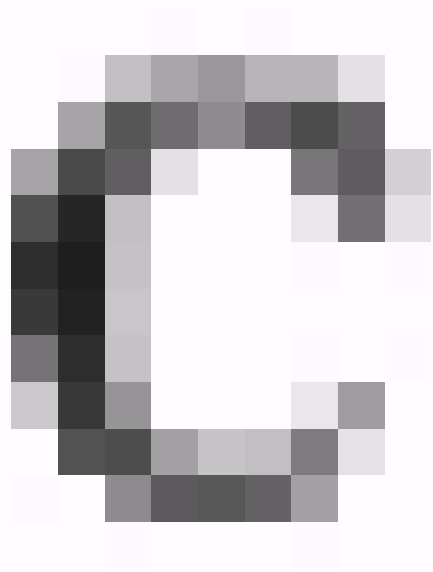
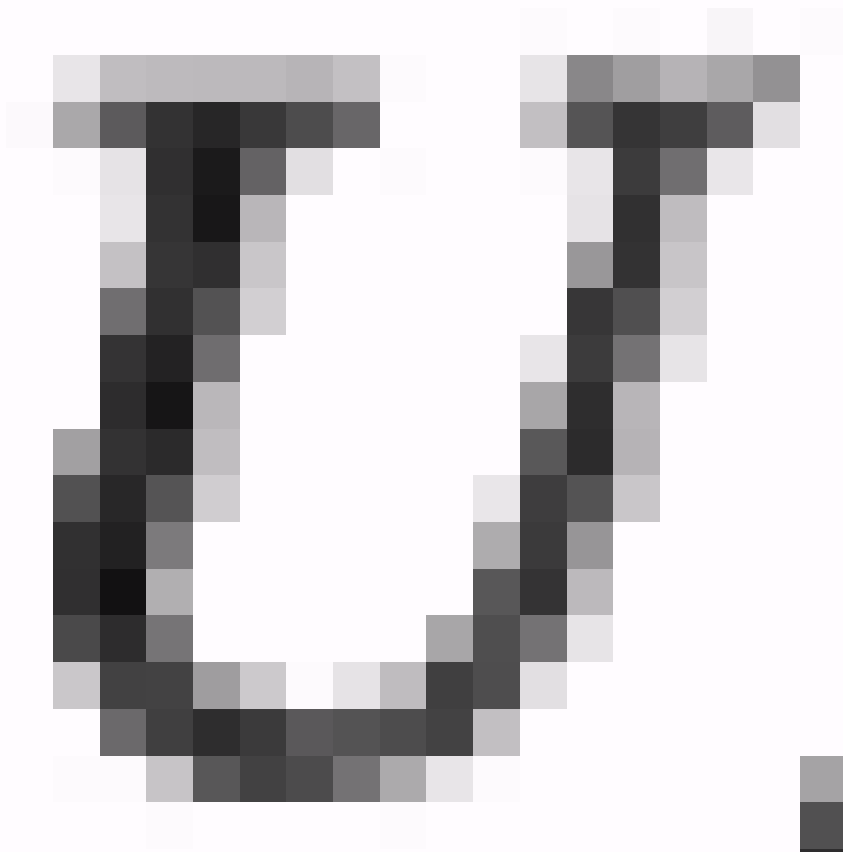

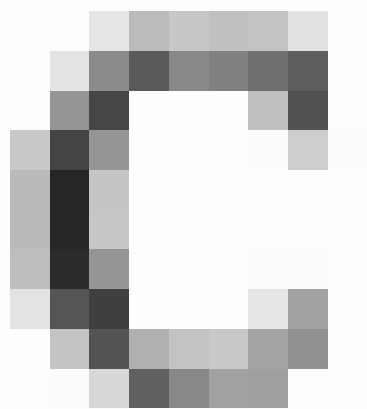
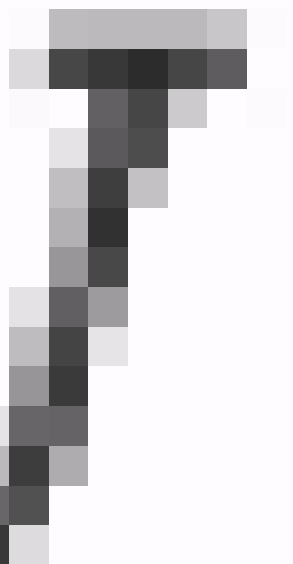
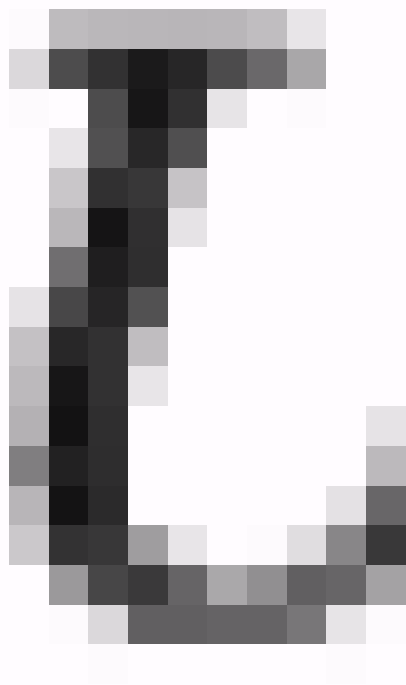

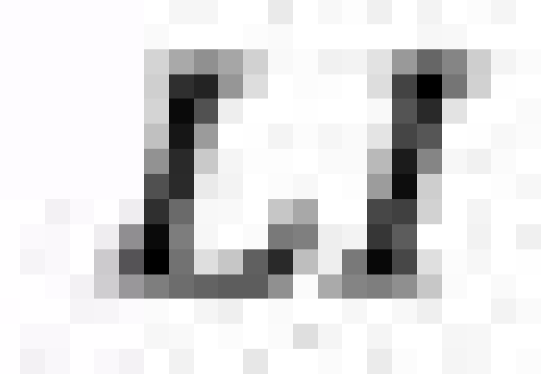
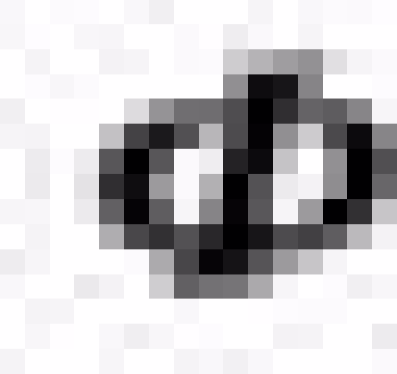

$$v_c = \frac{Q}{C} \quad (48.1)$$

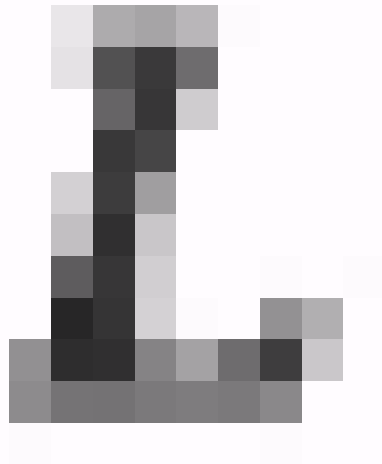
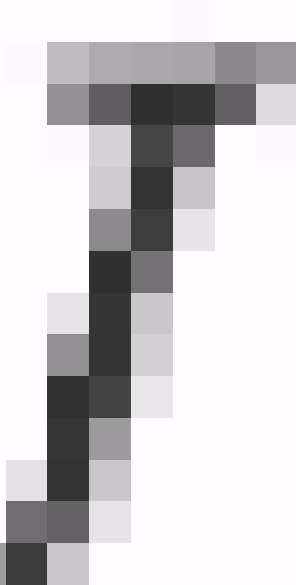
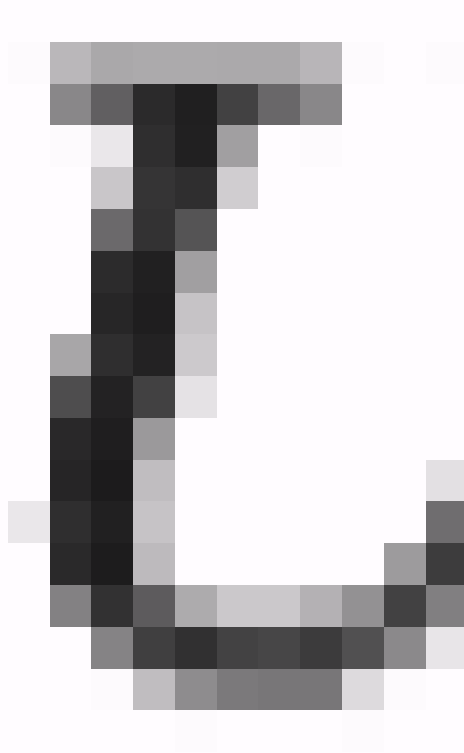

$$U_L = -E_w, \quad U_L = \frac{\Delta i}{\Delta t} \quad (48.2)$$

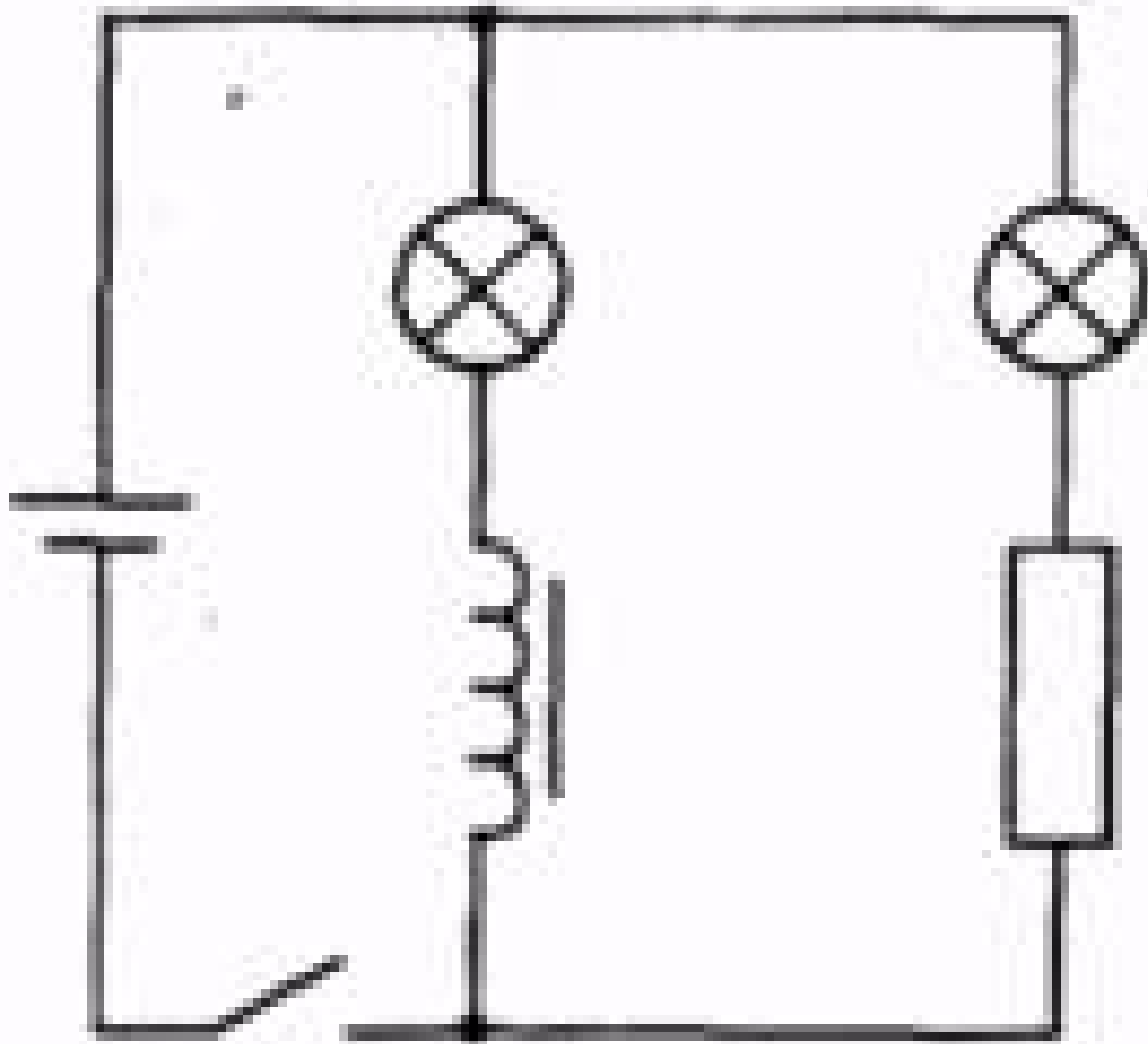

Мал. 2.155

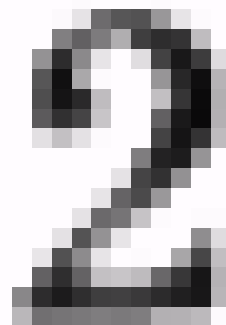
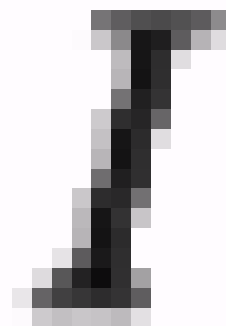
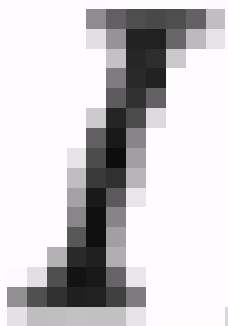





$$Q = \frac{1}{c} \frac{d}{dt} = \frac{1}{c} \frac{d}{dt} \cdot \frac{1}{2} = \frac{1}{2c} \frac{d}{dt}$$

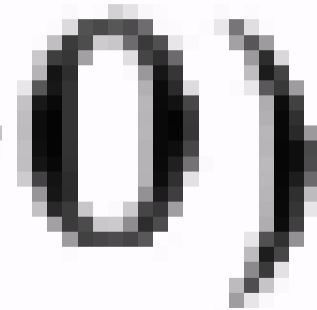
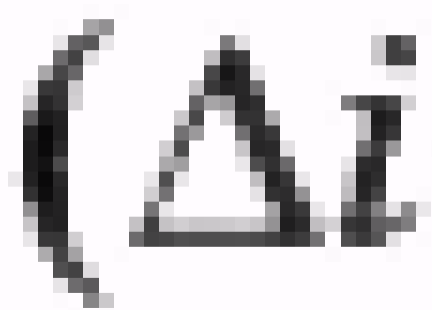
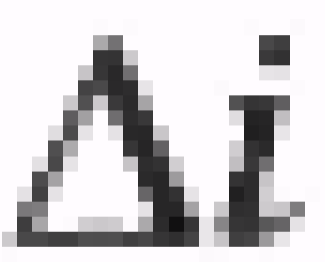

Q

=

11

=

11

11

11

.

$$A = qE_w = \frac{I_t}{2} + \frac{LI}{2} = \frac{LI^2}{2}$$

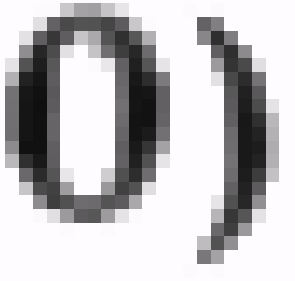
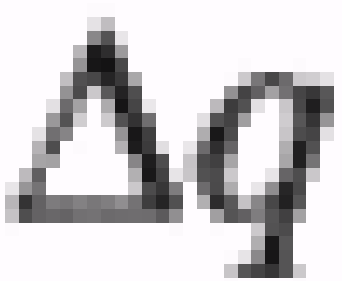
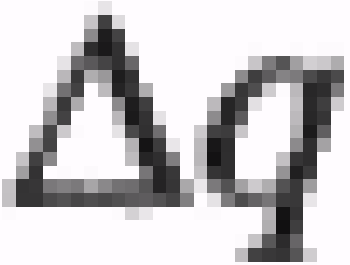

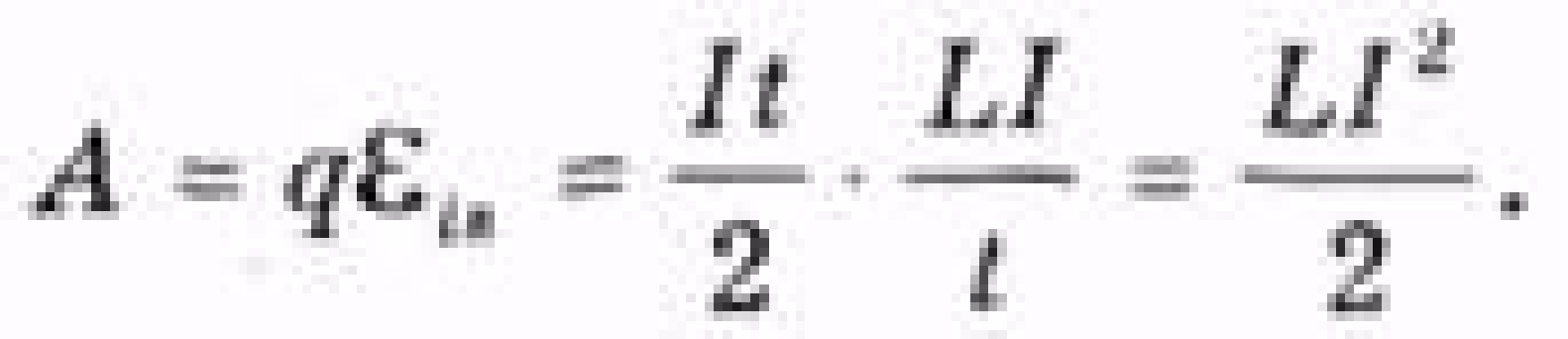

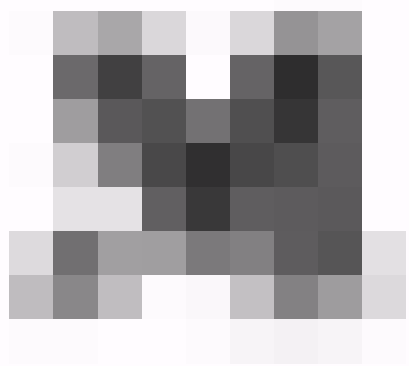
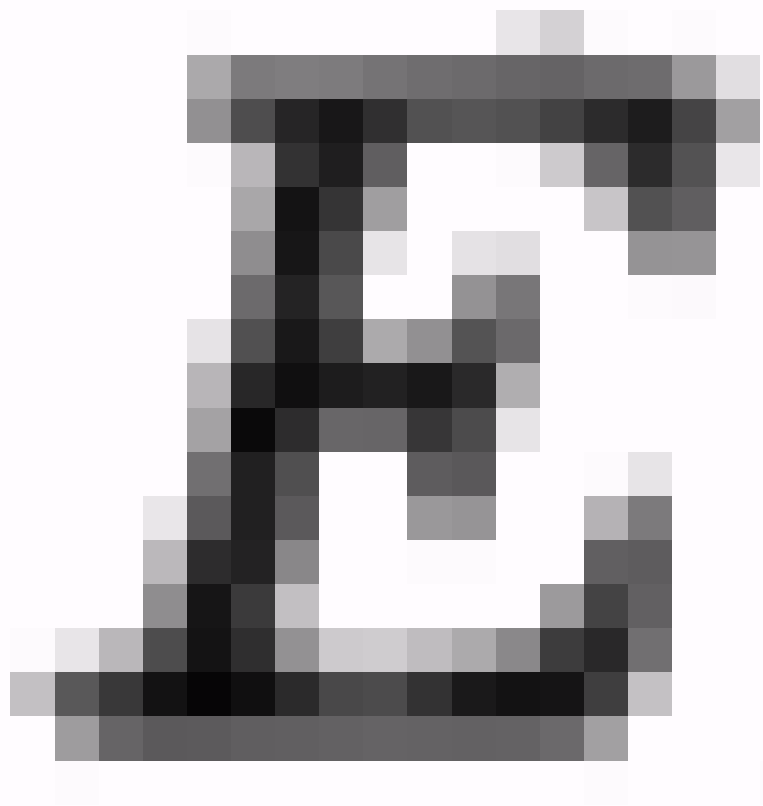

U
L

=

U
L

U
L

U
L

U
L

U
L

U
L

U
L

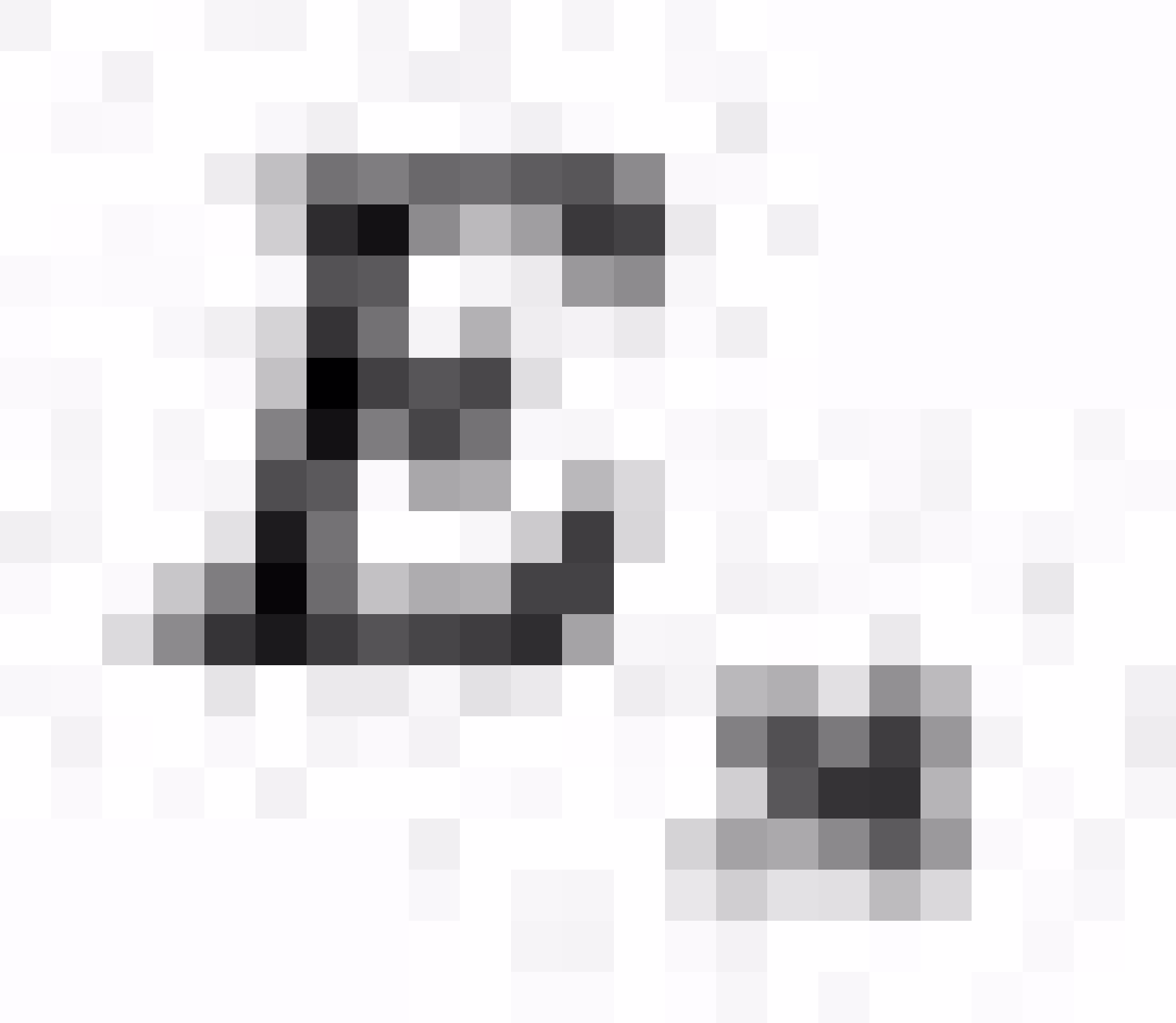

$$E_N = \frac{L_1 L_2}{2}$$

(47.3)

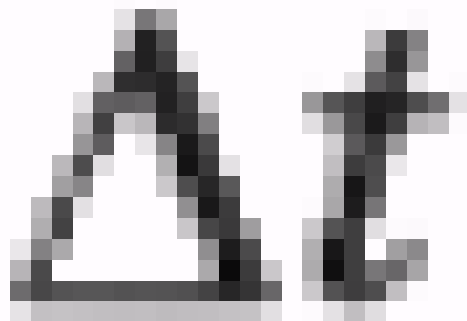
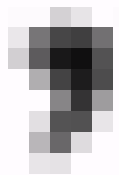
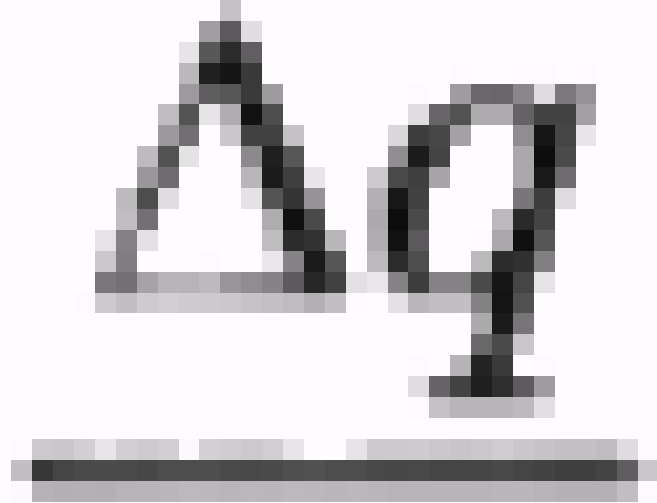
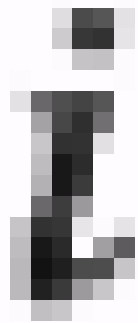

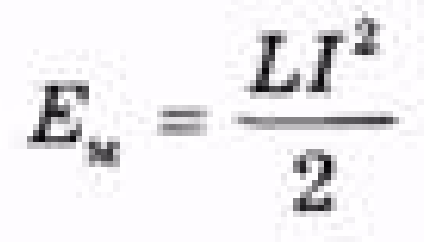



Мал. 2.156

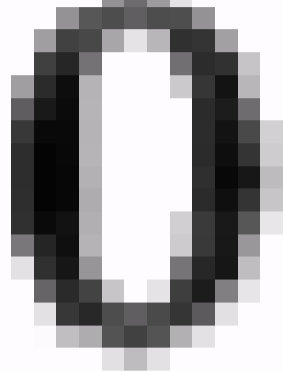
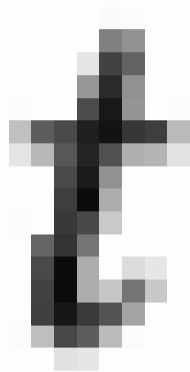
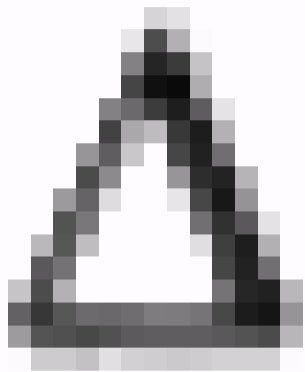

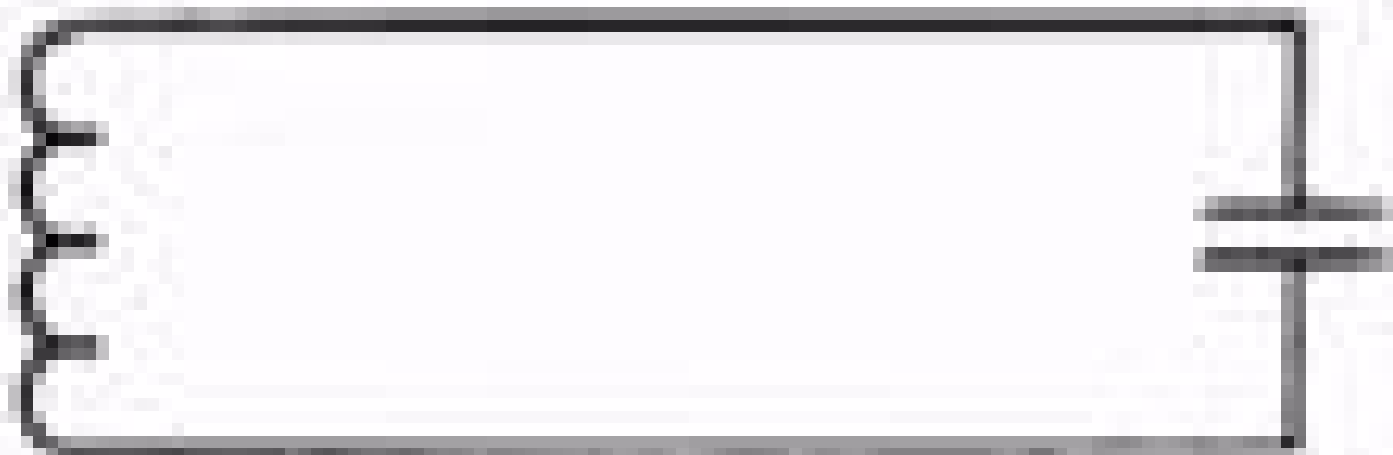

Mar. 2. 156

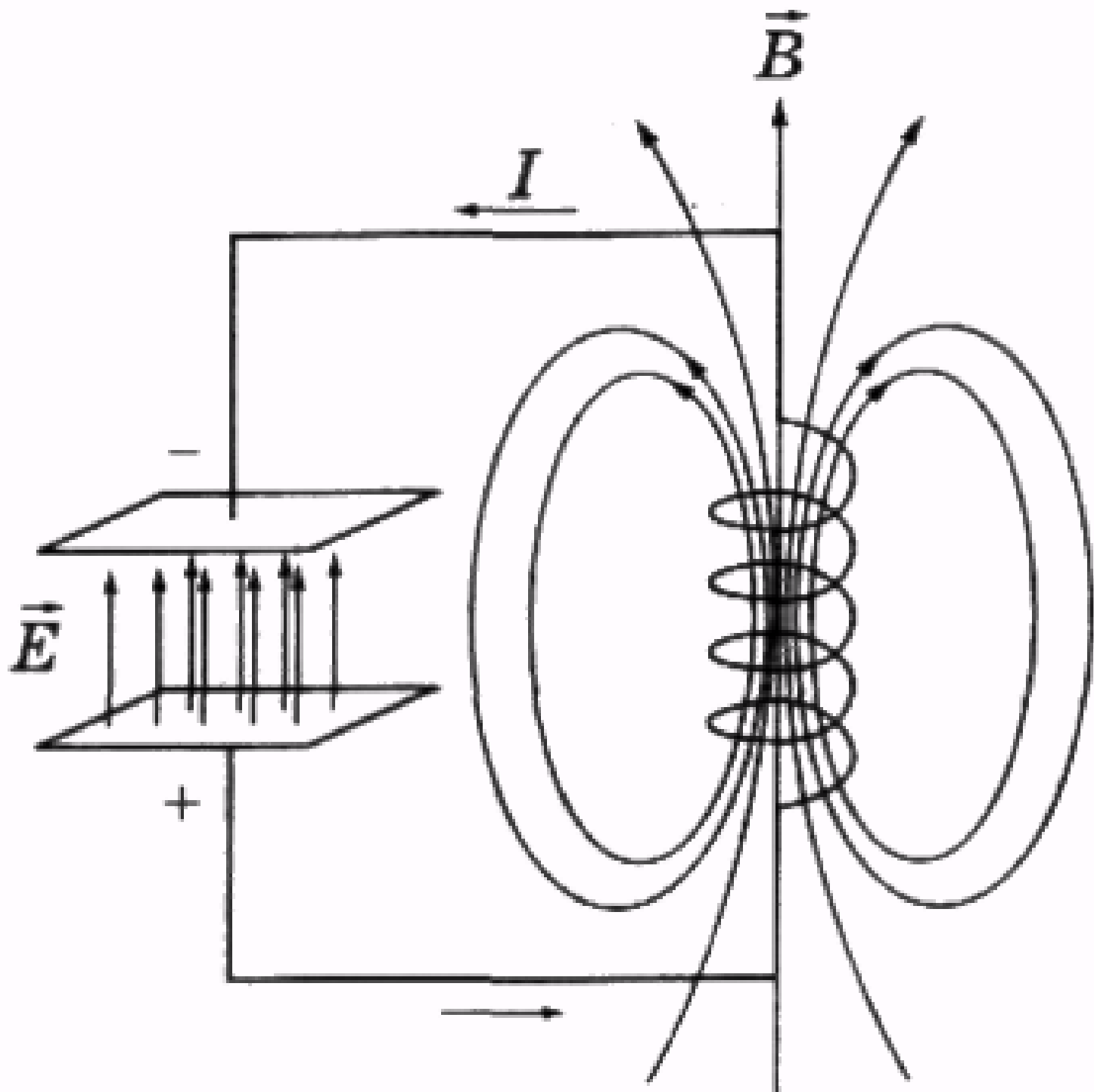

Мал. 2.157

$$\dot{q} = \dot{q}' \quad (48.4)$$

$$U_L = L \dot{q}'^2 \quad (48.5).$$

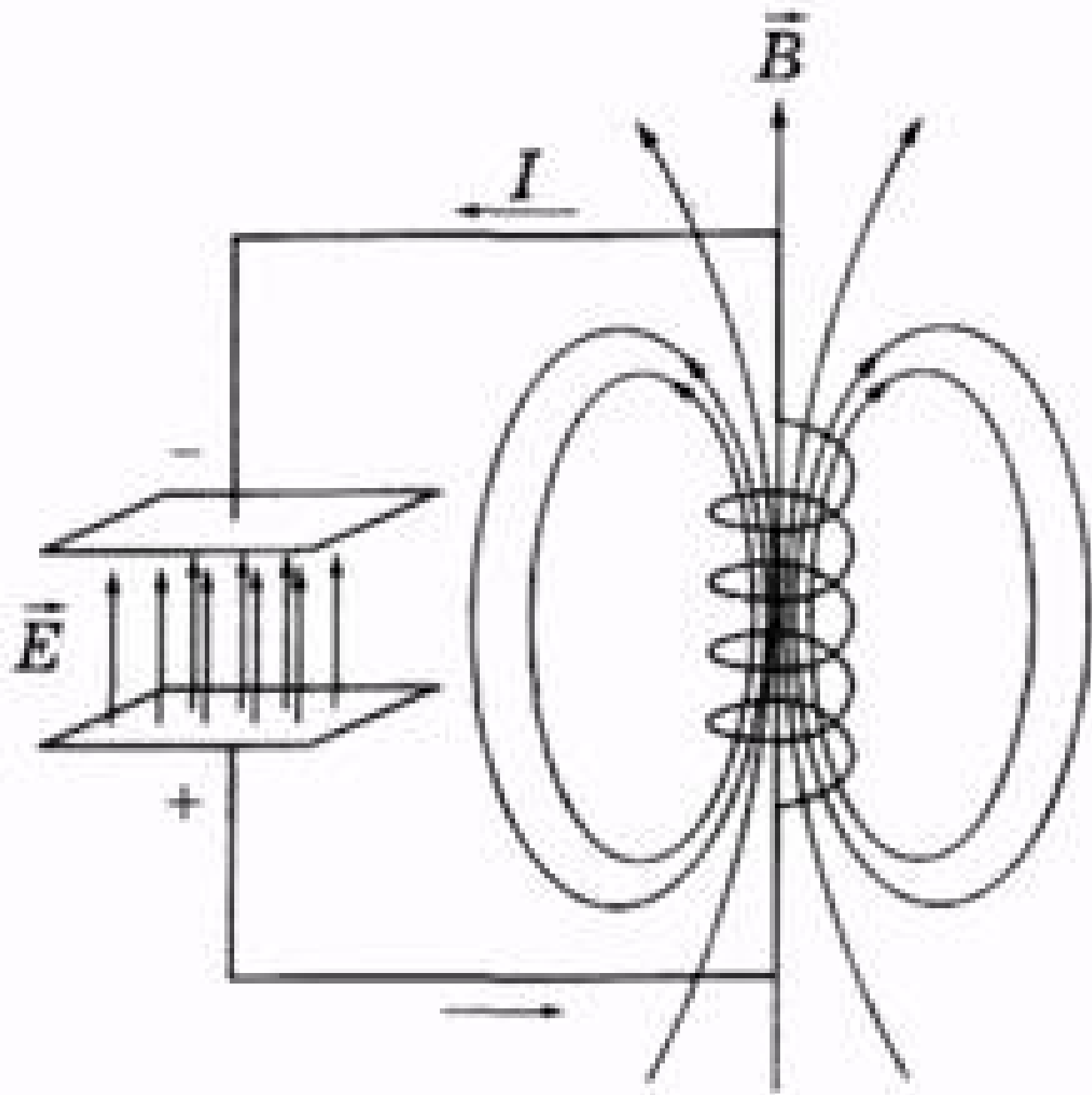

Мал. 2.157

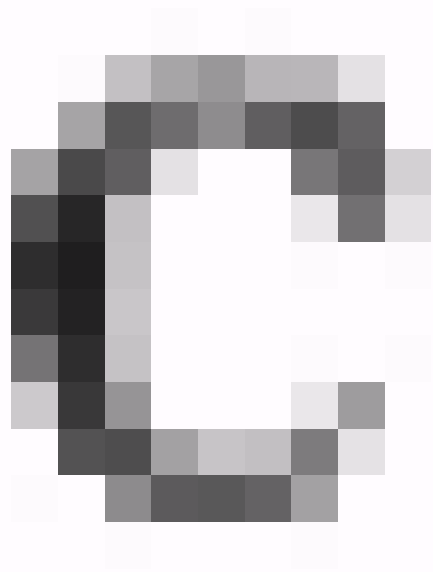
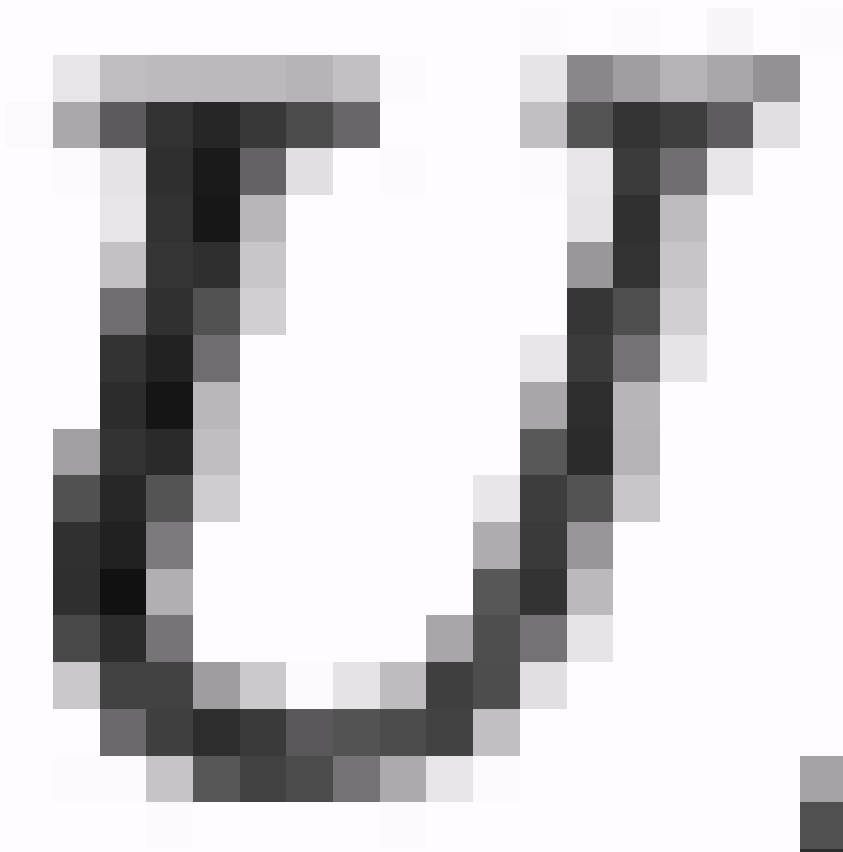

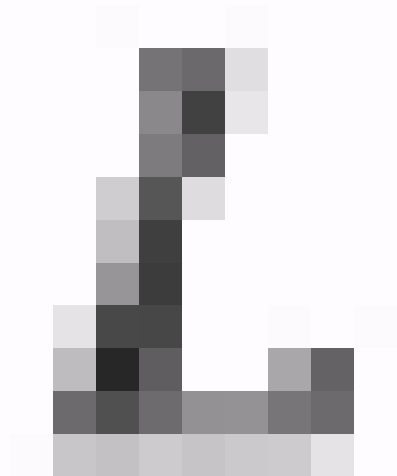
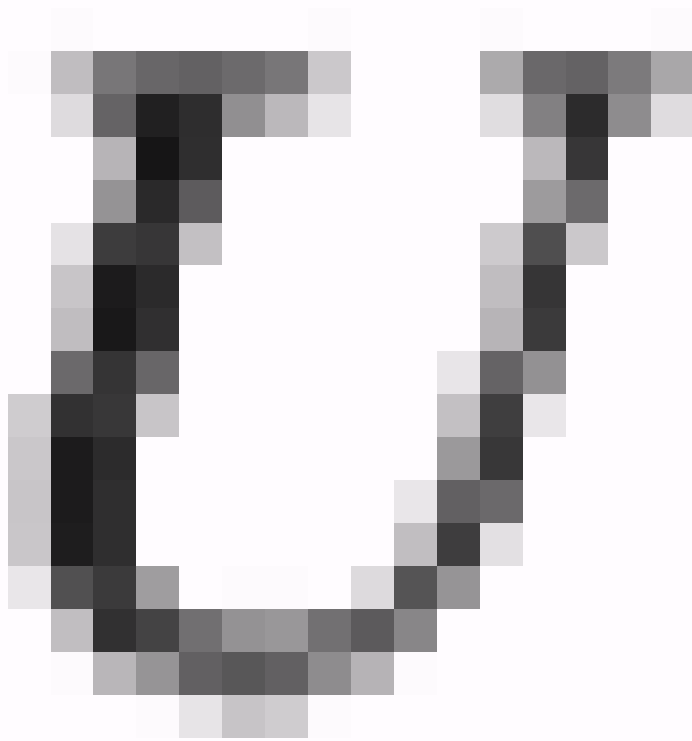



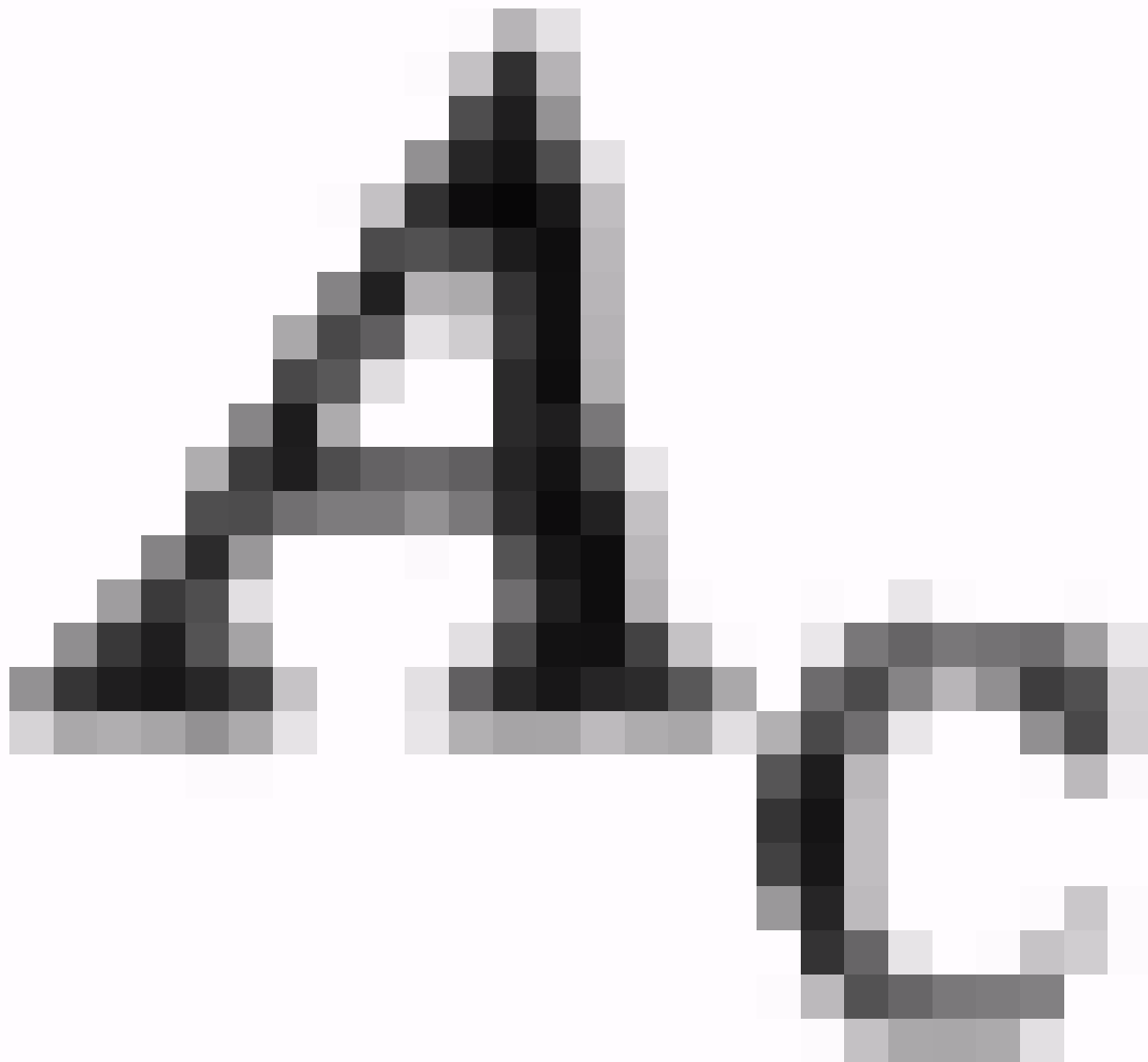

Ac

=

QVC

(480)



$$v_c = \frac{Q}{C} \quad (48.1)$$

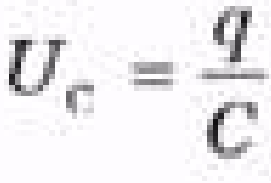

$$A = A_c + A_L = QV^T_c + QV^T_L = 0 \quad (48.8)$$

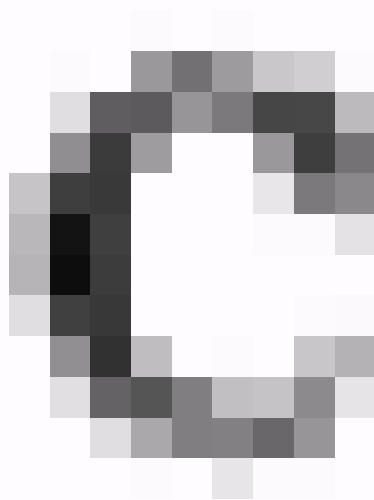
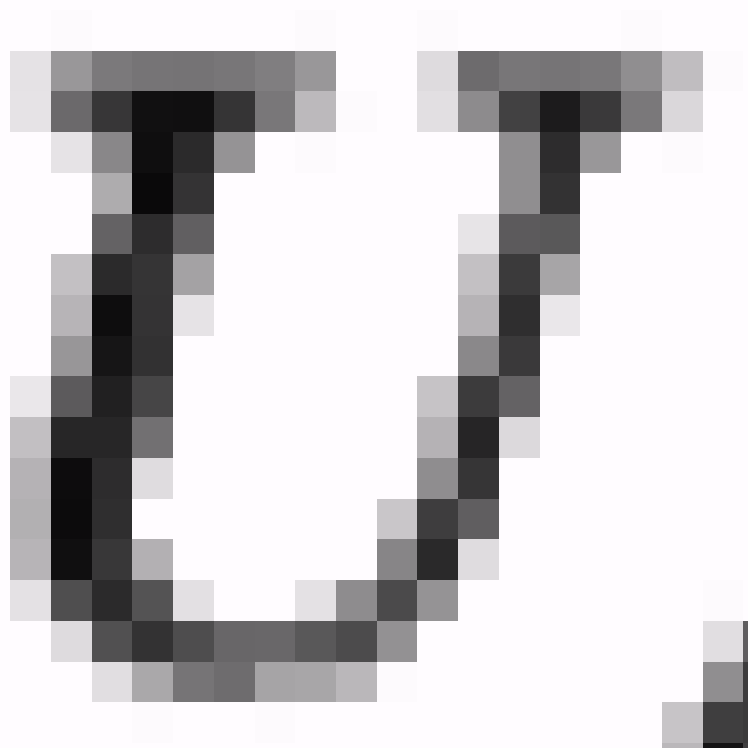

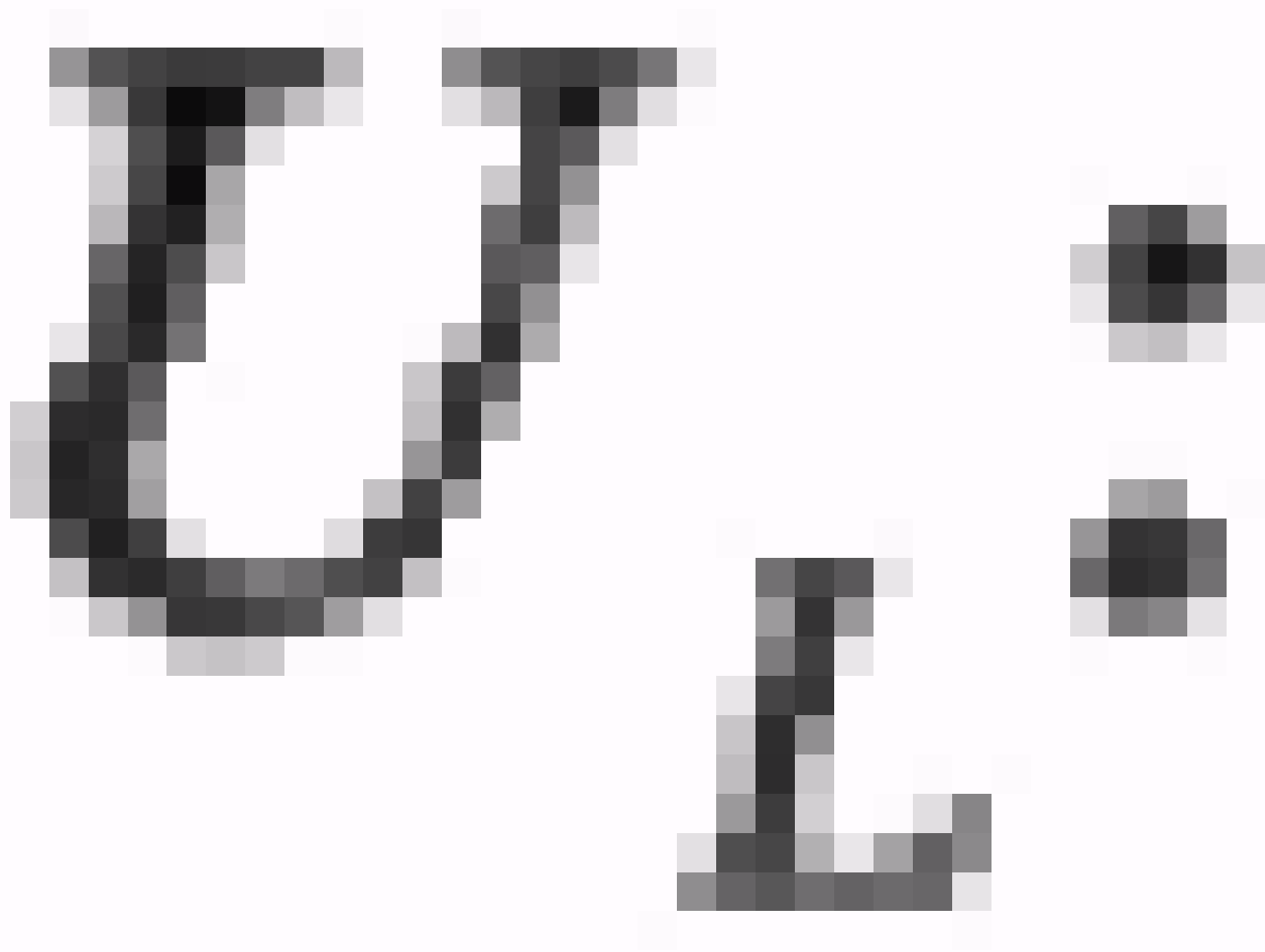

$$U_C = -U_L \quad (48.9).$$

$$\frac{q}{C} = -Lq'', \quad q'' = -\frac{1}{LC}q \quad (48.10).$$

$$q = q_0 \cos \omega t \quad (48.11),$$

де
$$\omega = \sqrt{\frac{1}{LC}} \quad (48.12).$$

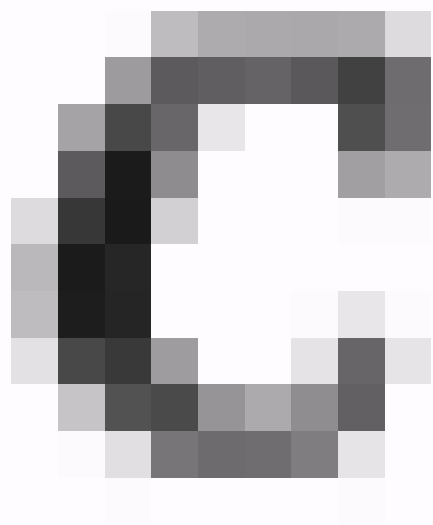
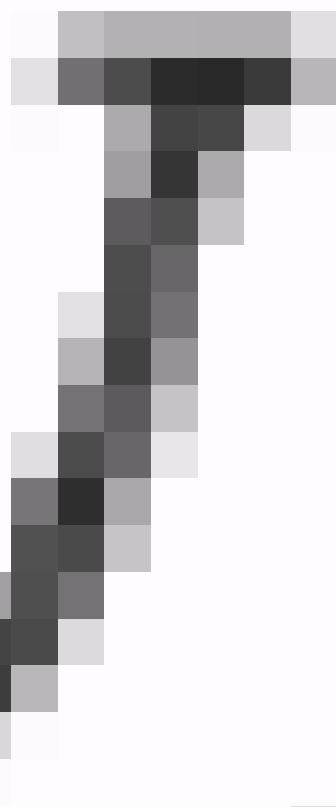
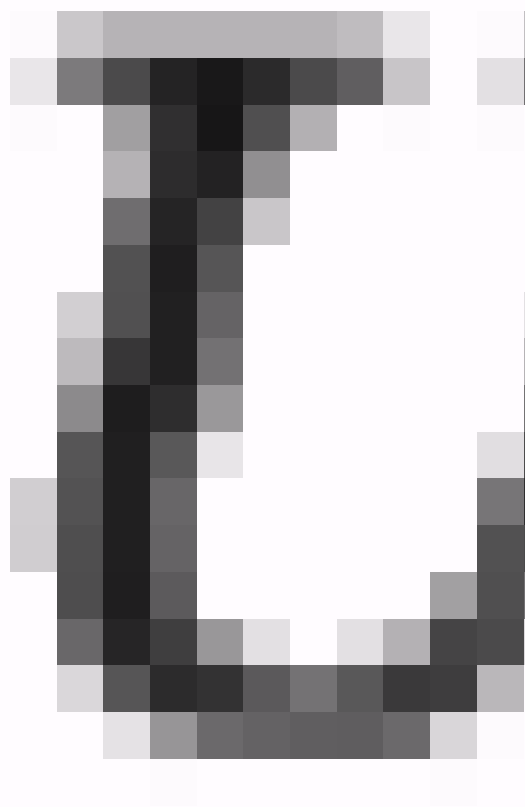

$$V_c = \frac{Q_0}{C} \cos \omega t \quad (48.13)$$



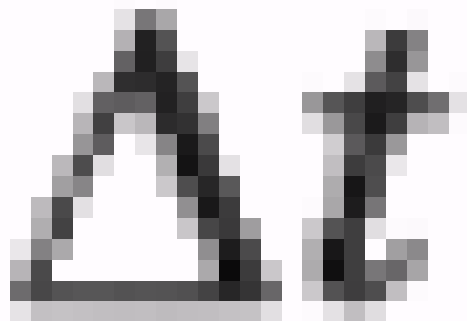
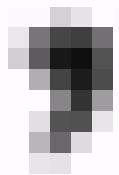
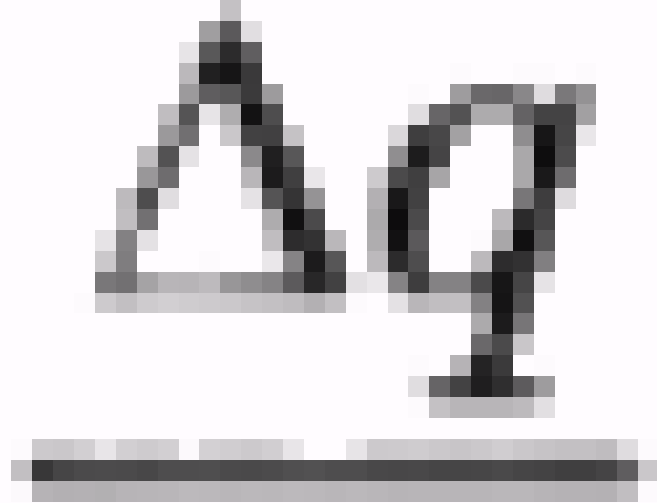
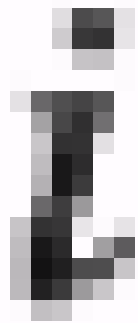

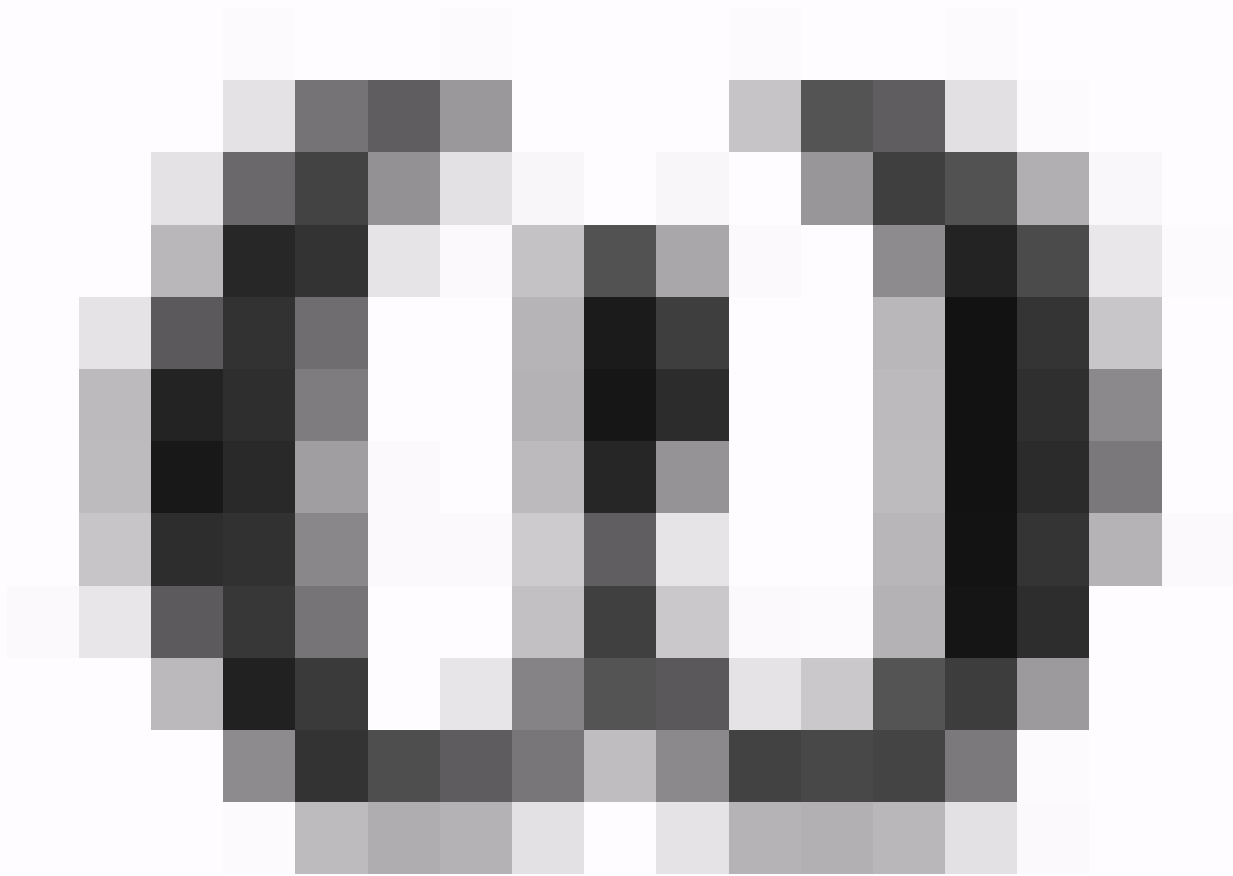

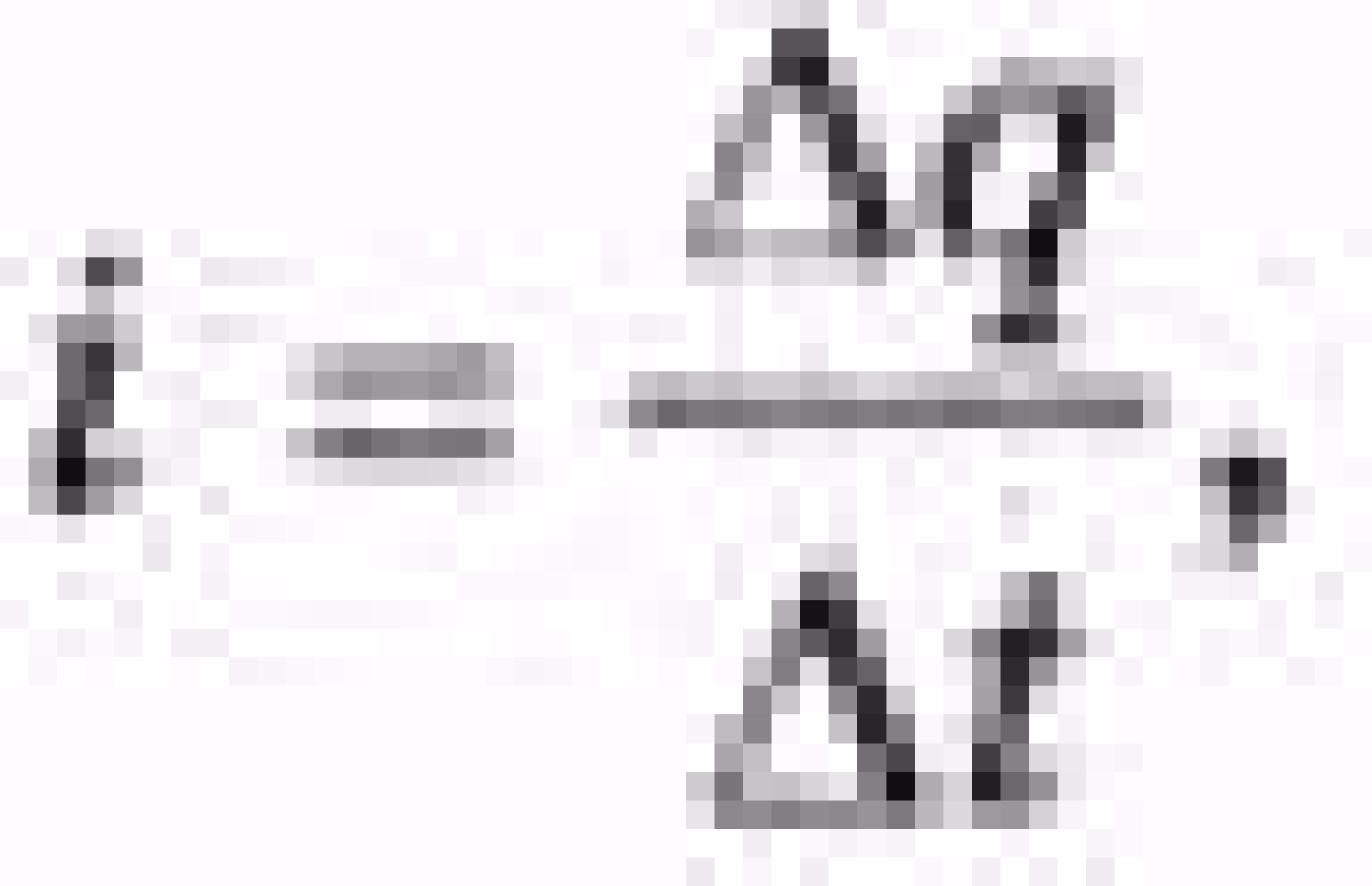

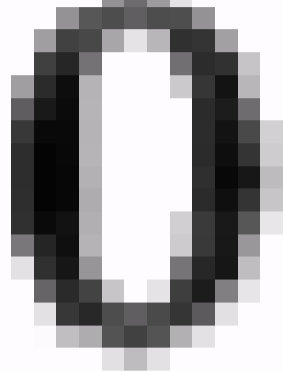
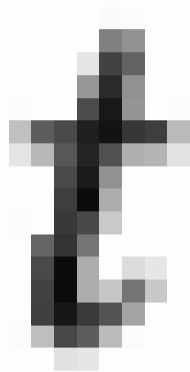
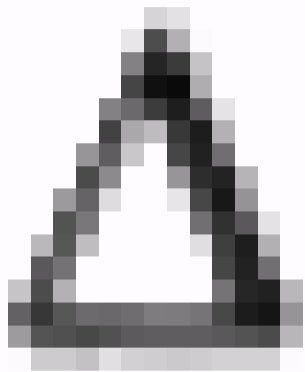

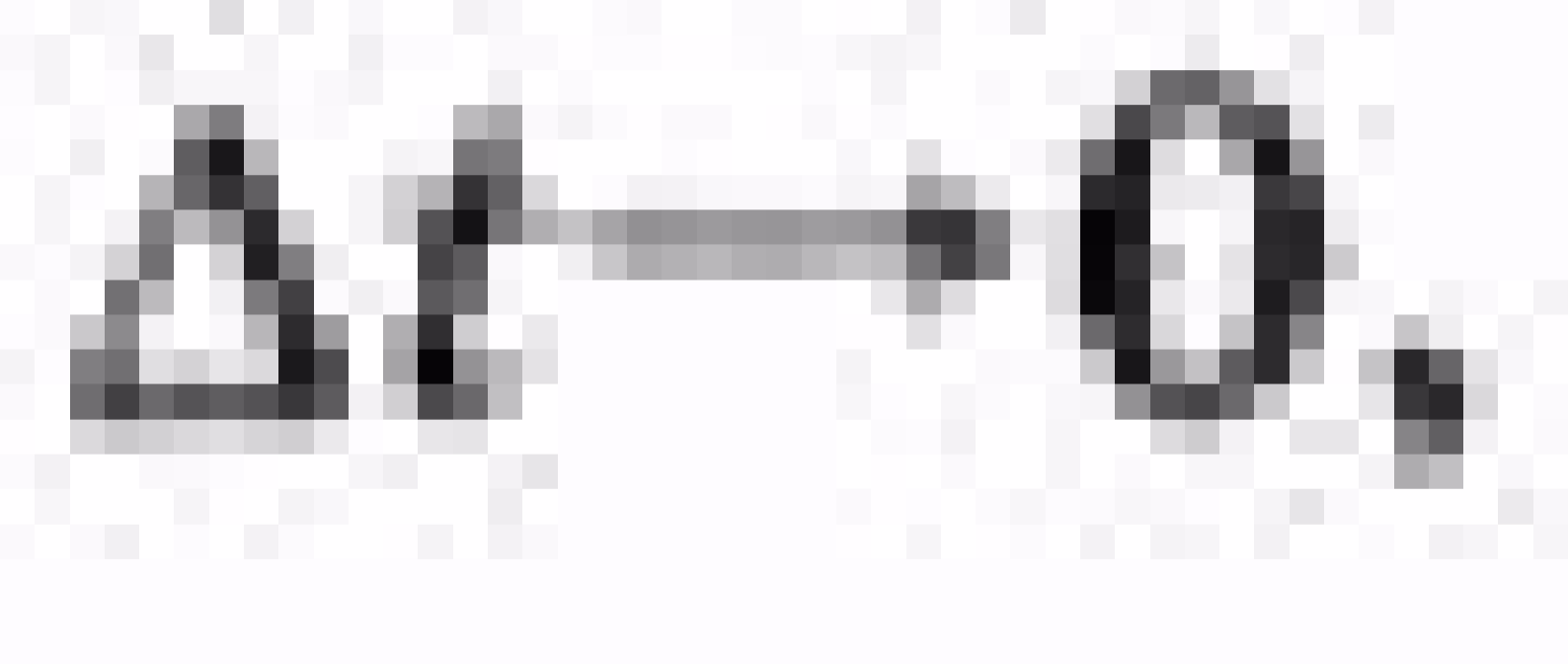

$$\dot{q} = \dot{q}' \quad (48.4)$$

$$U_L = L \dot{q}'^2 \quad (48.5).$$

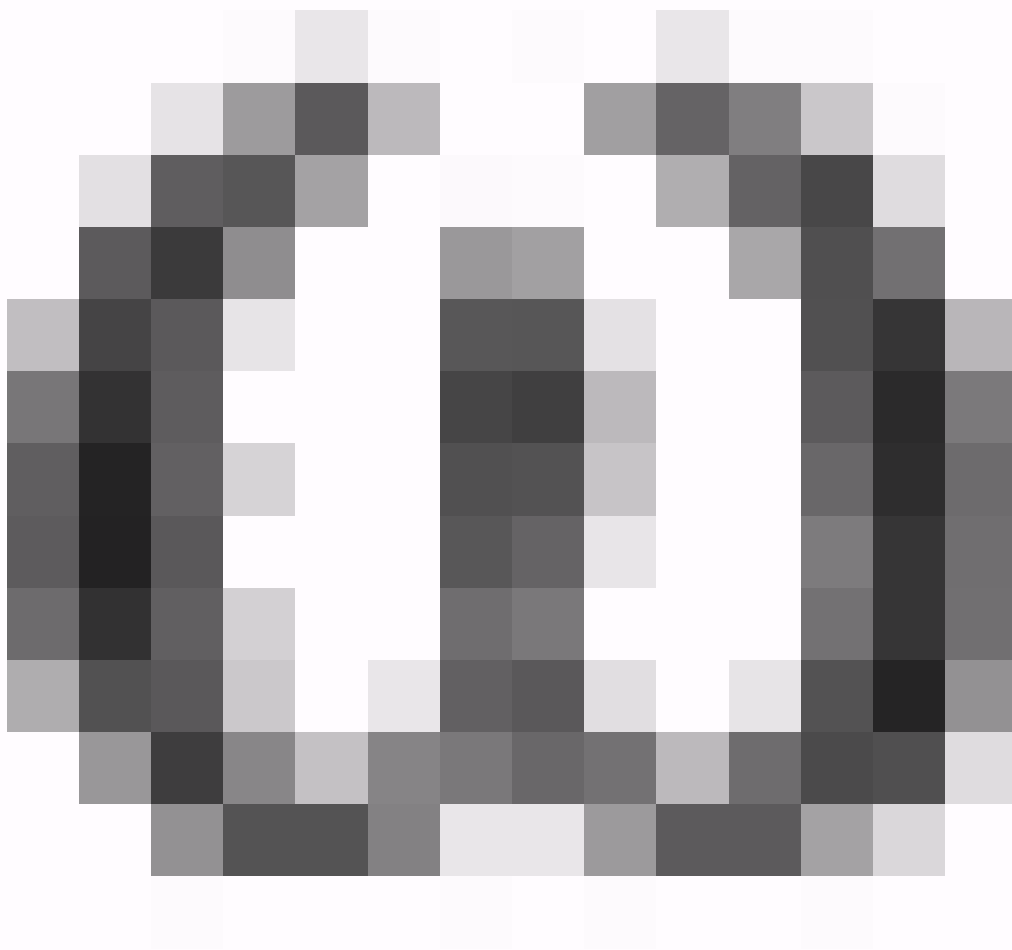

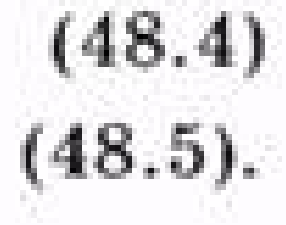
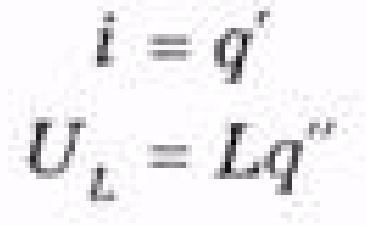

$$T = \frac{2\pi}{\omega}$$

(B.15)

$$T = 2\pi\sqrt{LC}$$

(B.15)

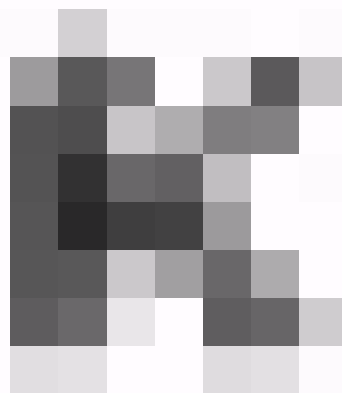
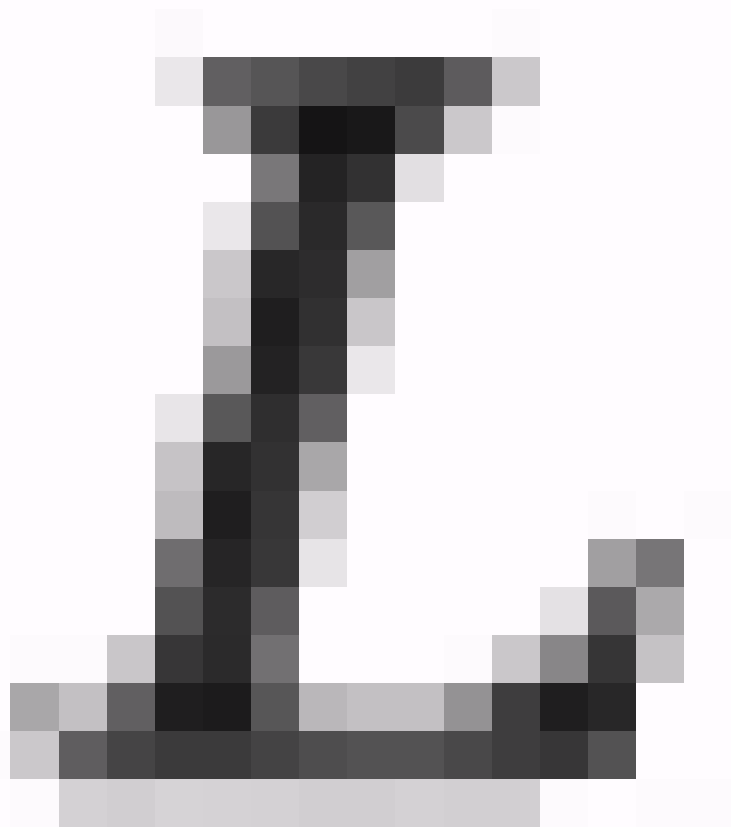

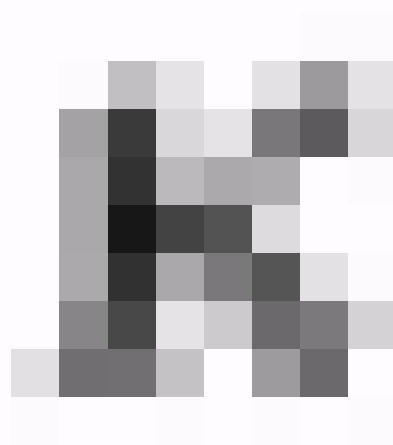
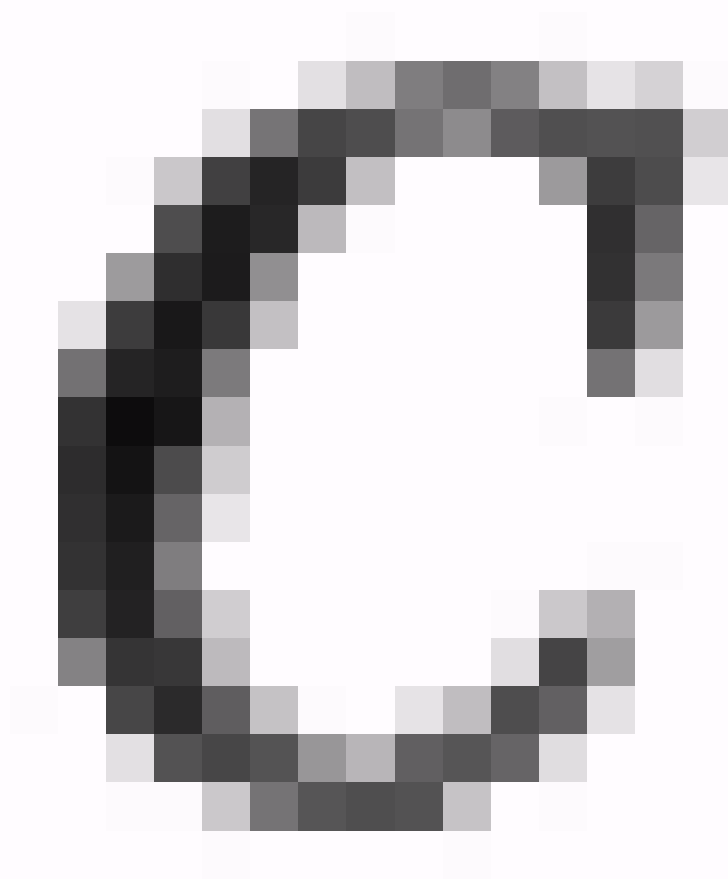





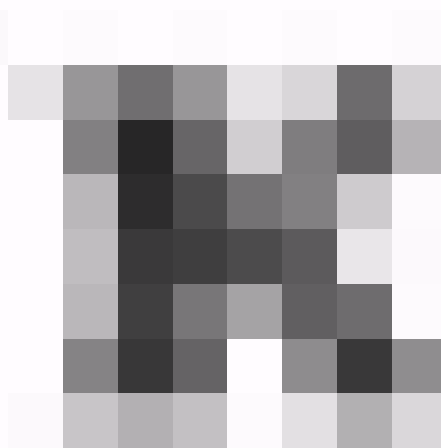
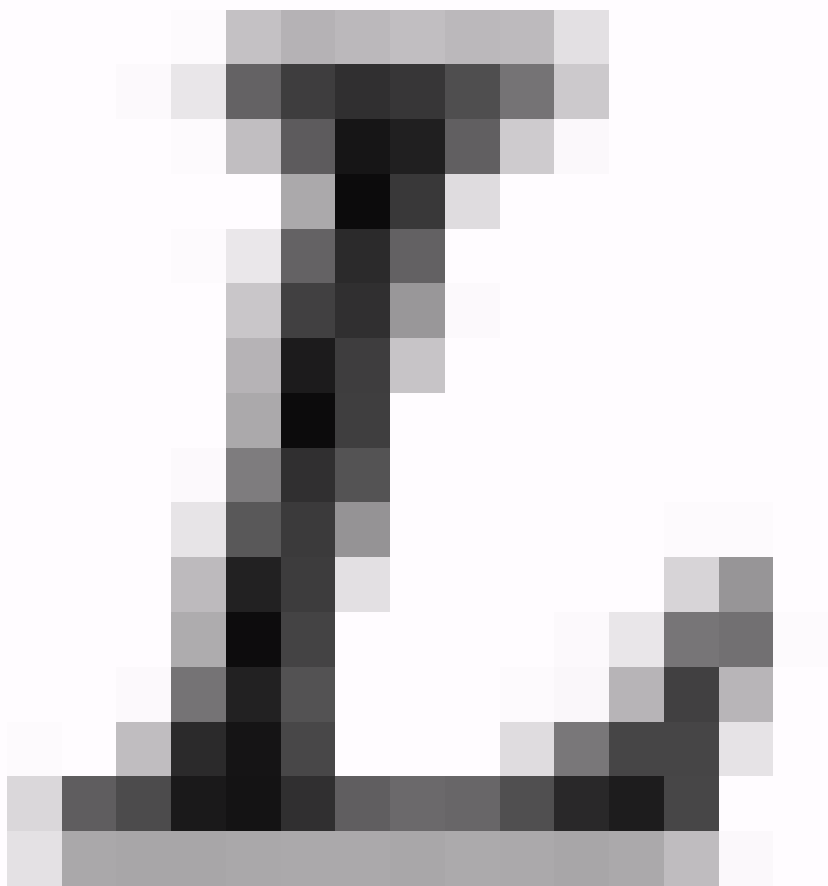



$$A = A_c + A_L = QV^T_c + QV^T_L = 0 \quad (48.8)$$

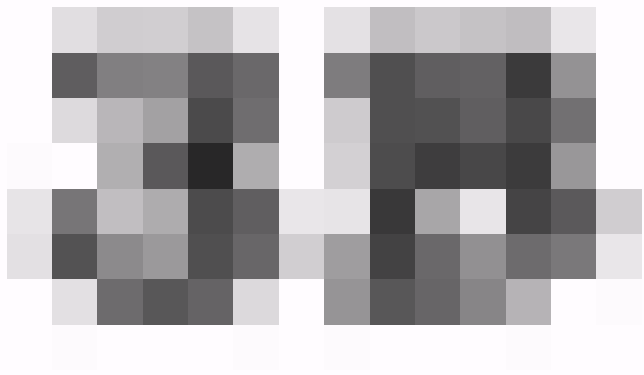
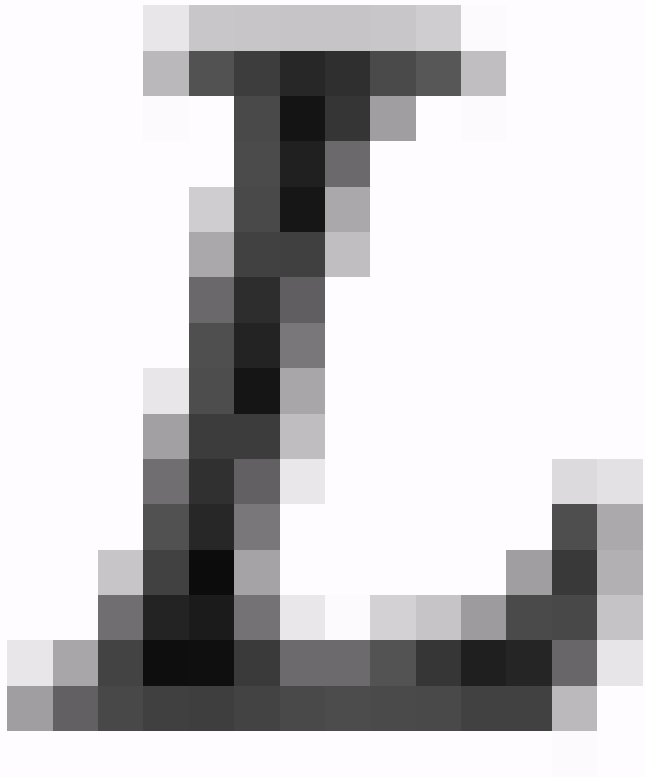

1-800-4-A-FLORIDA

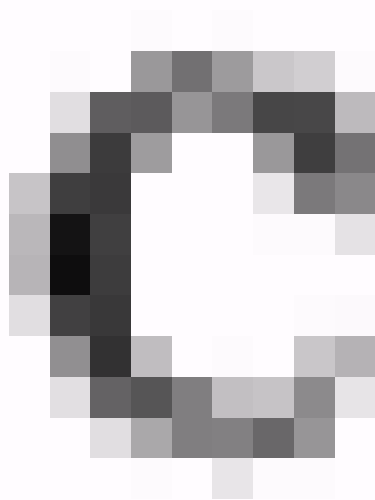
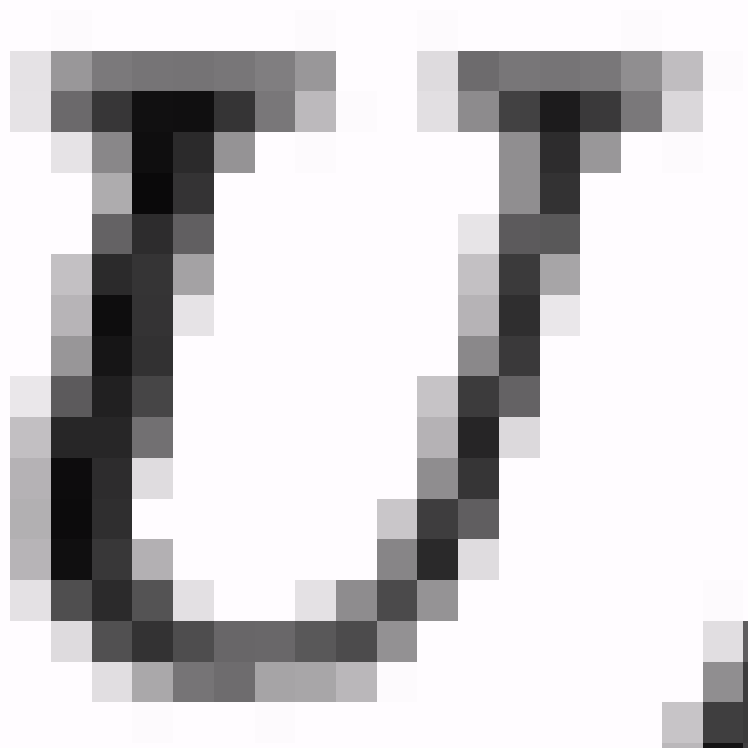

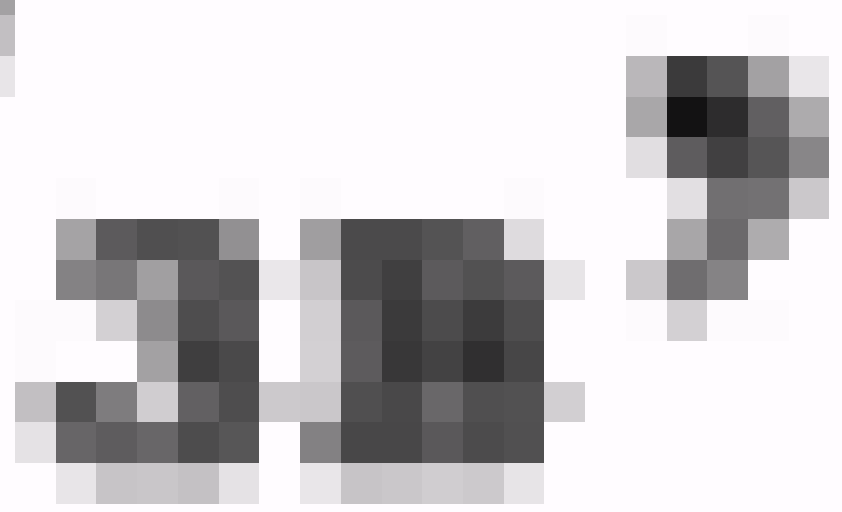
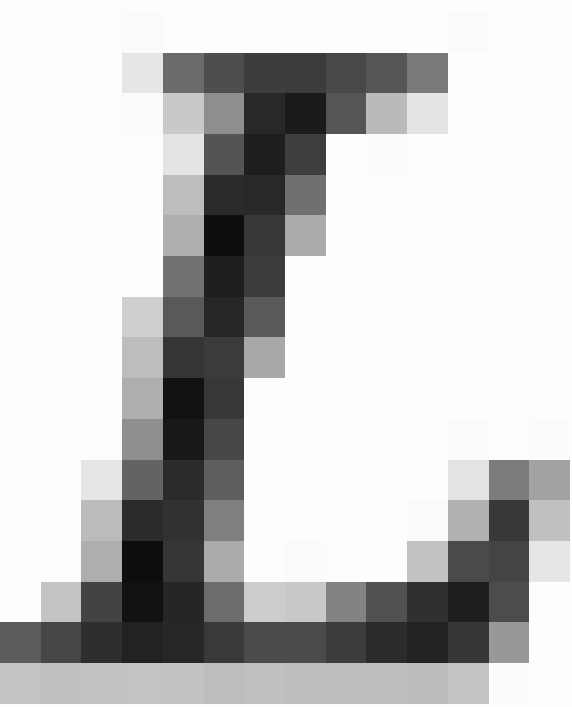



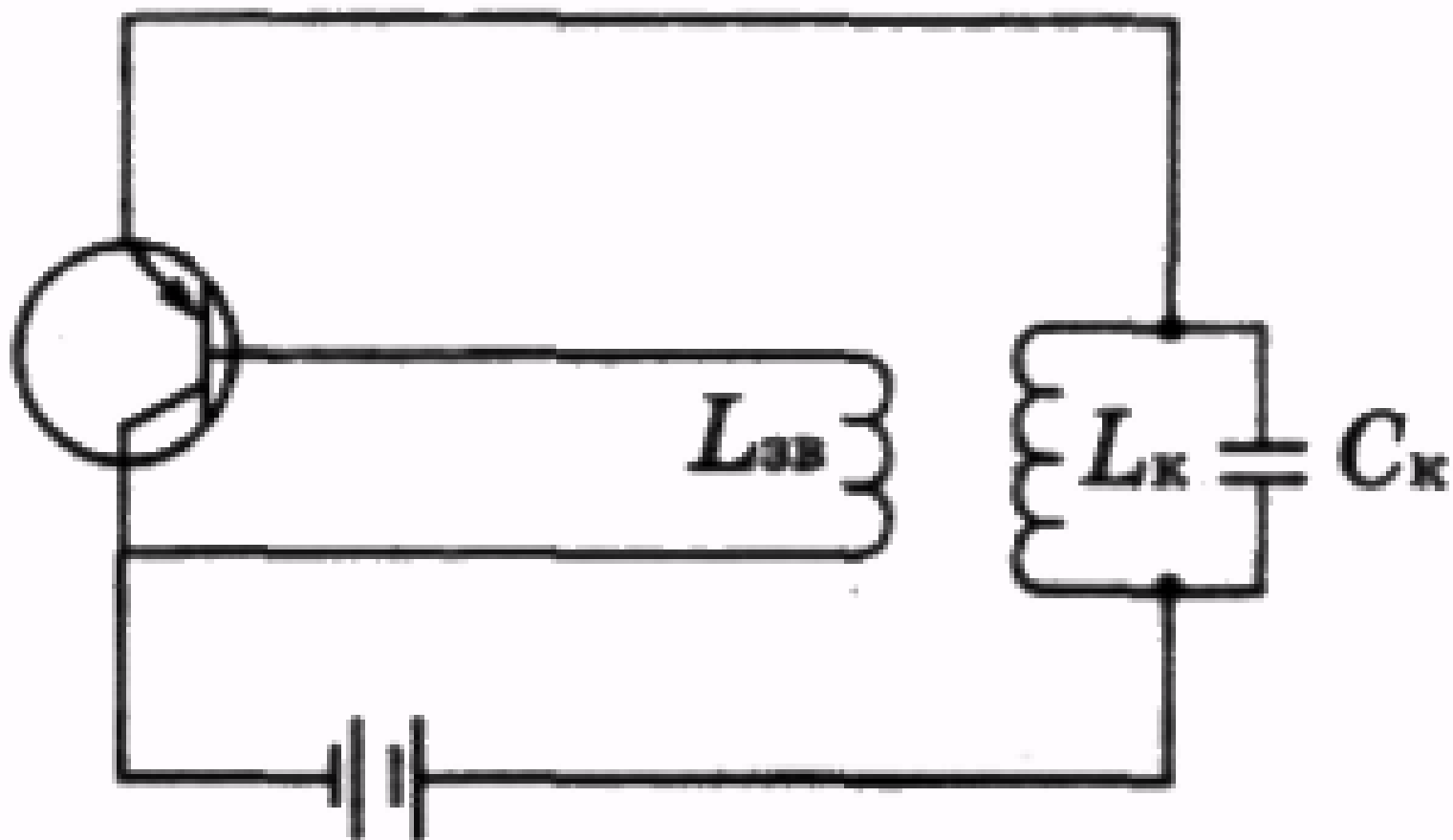

Мал. 2.158

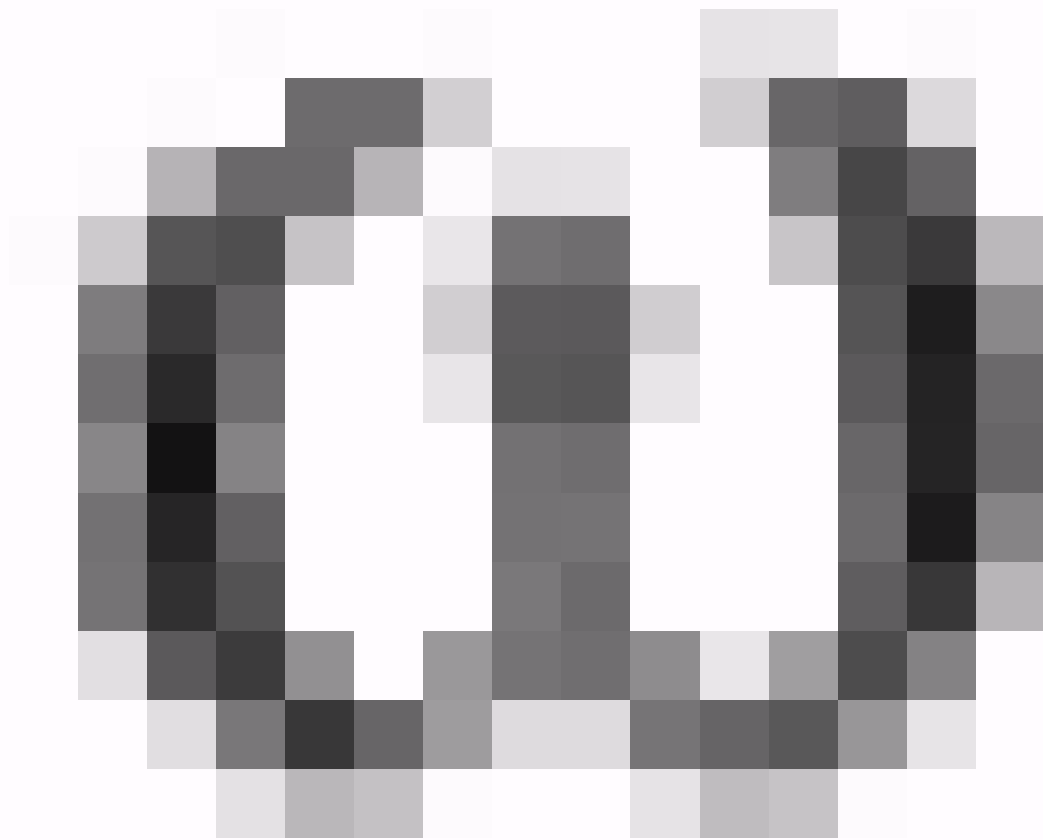

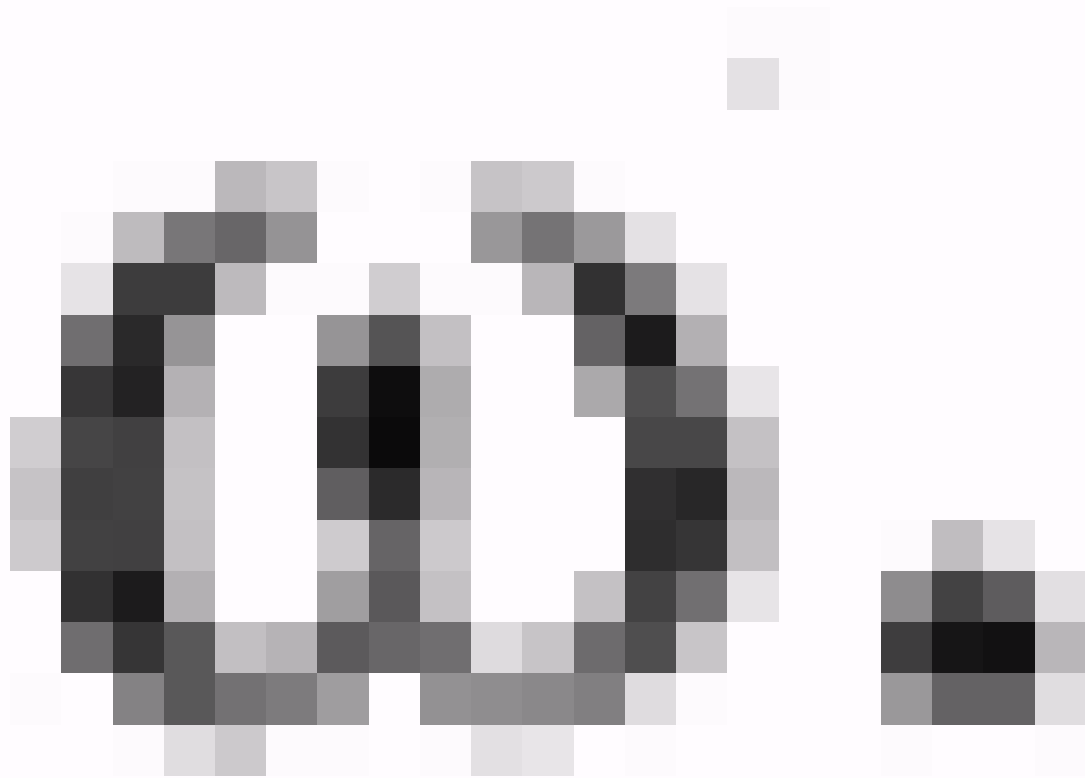

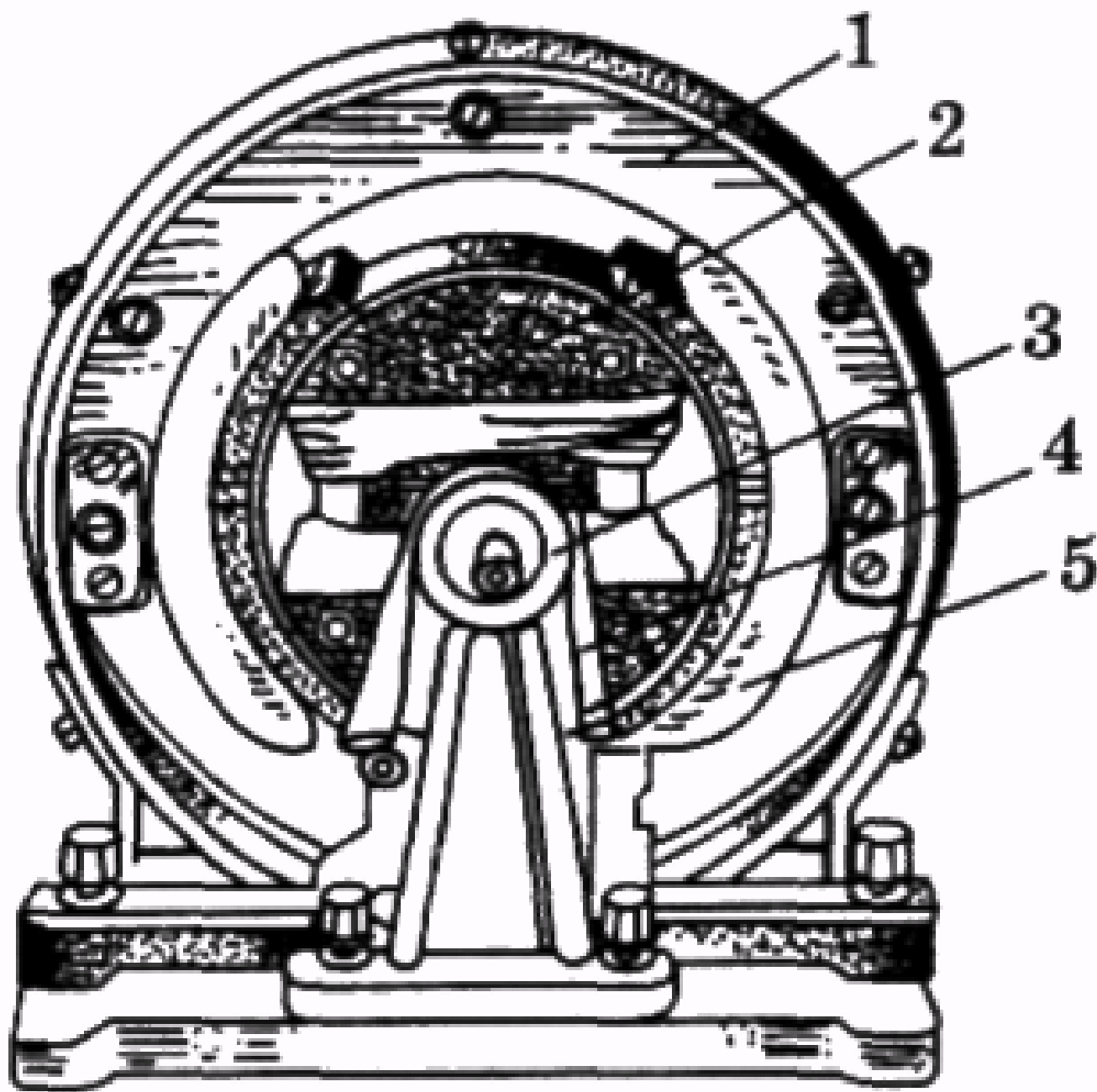

Мал. 2.159

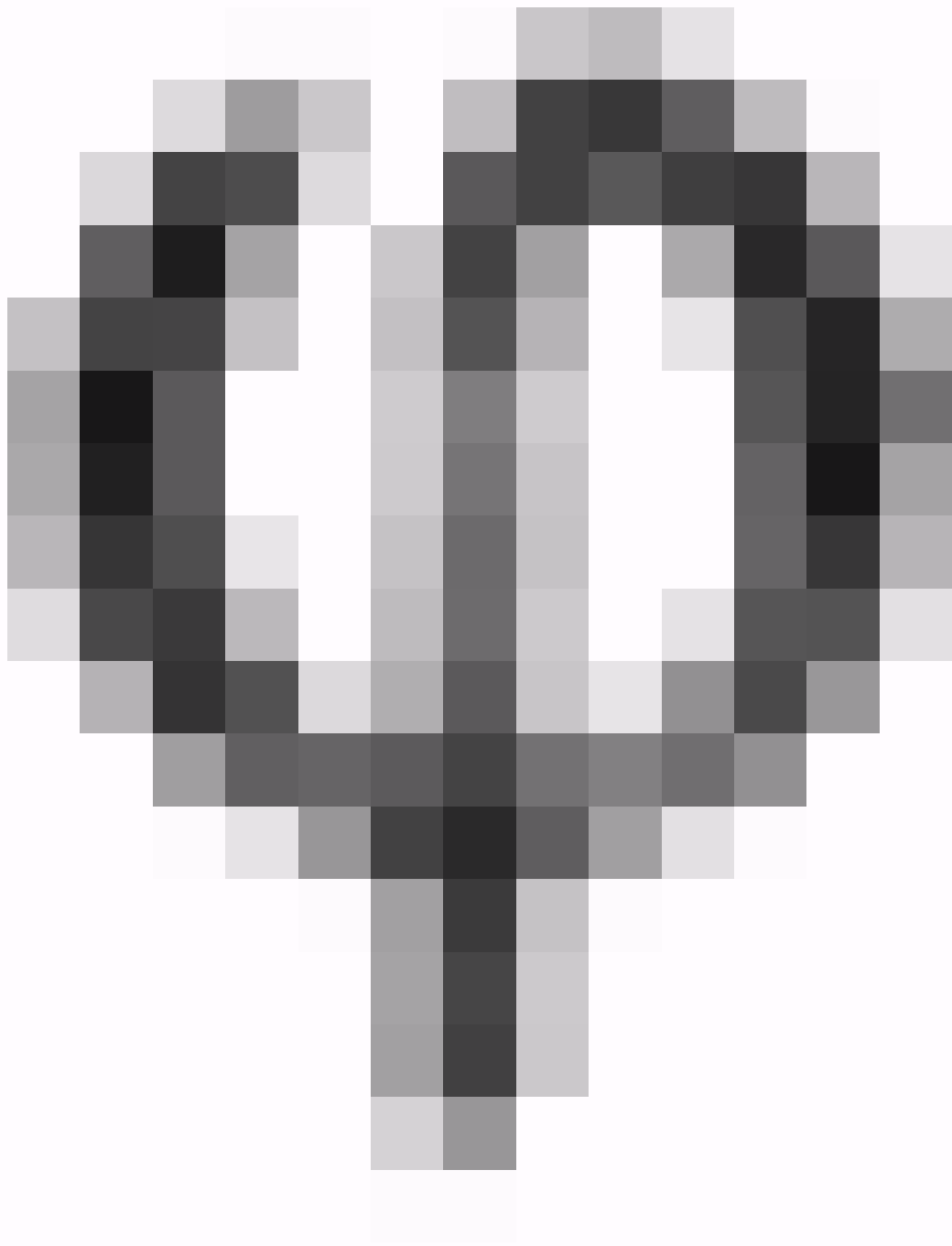

$\Phi = BS \phi$ (40.1)

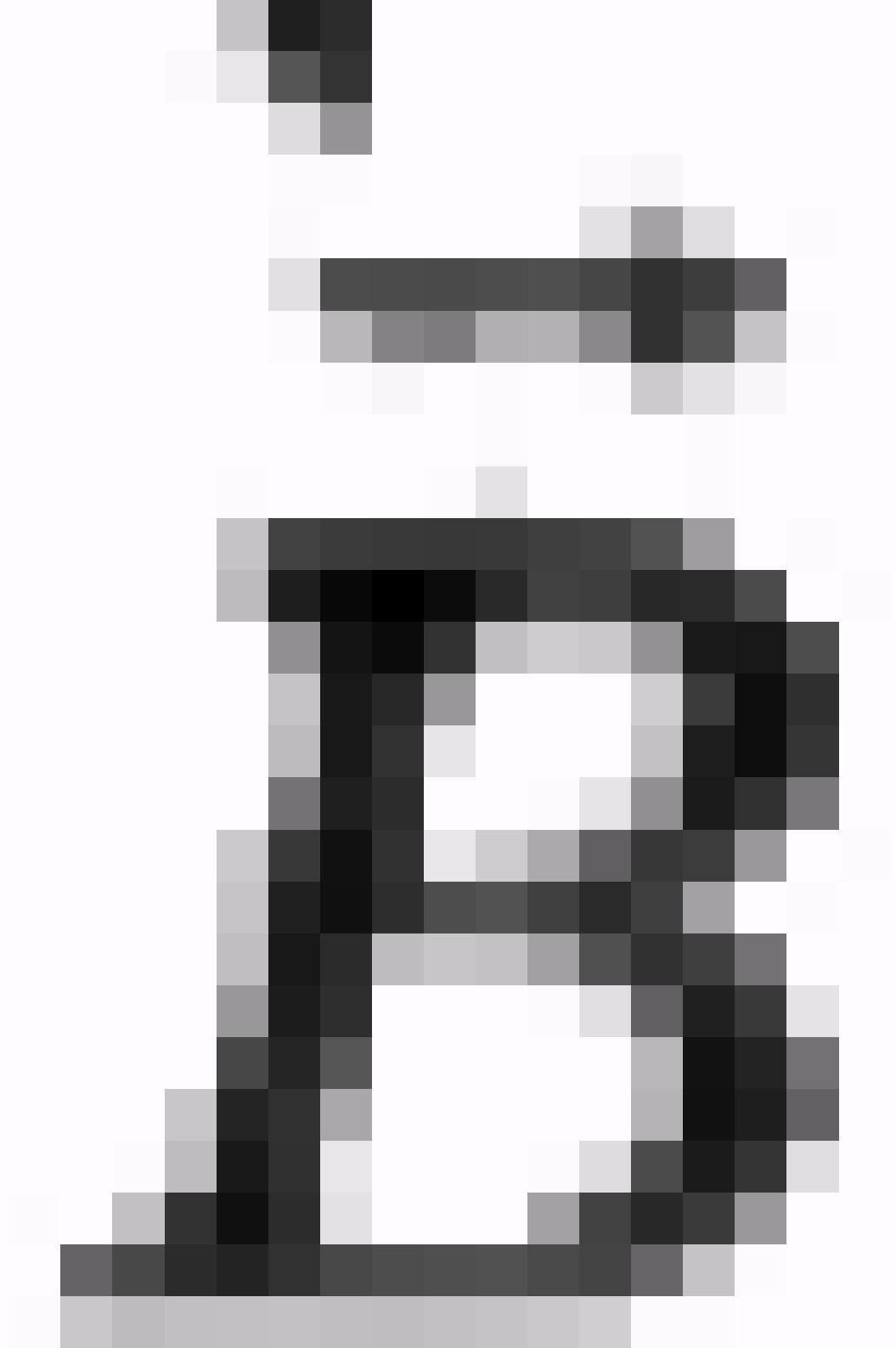

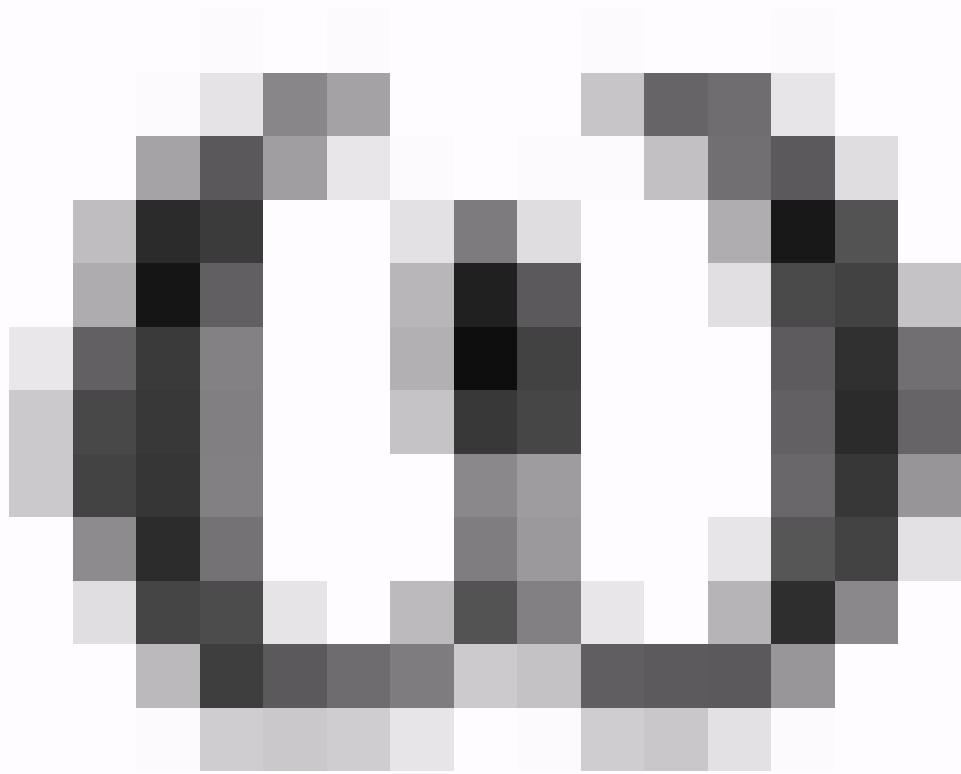

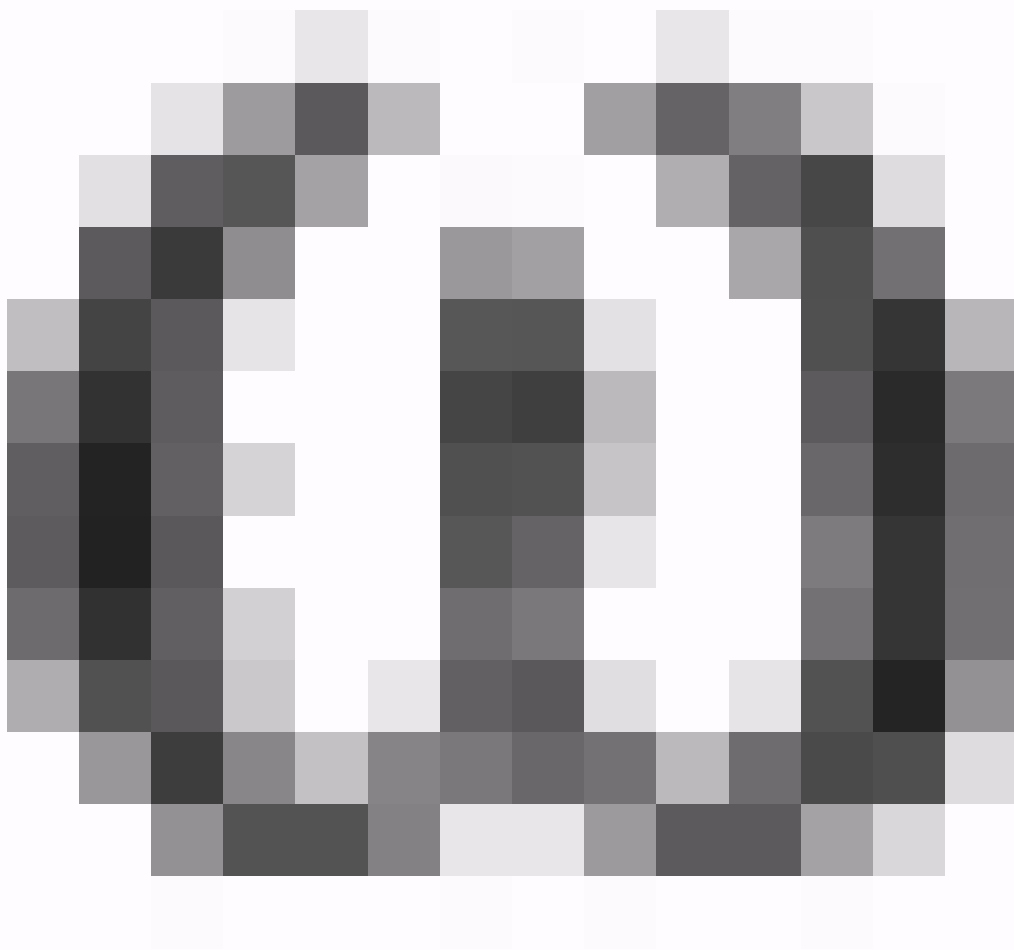

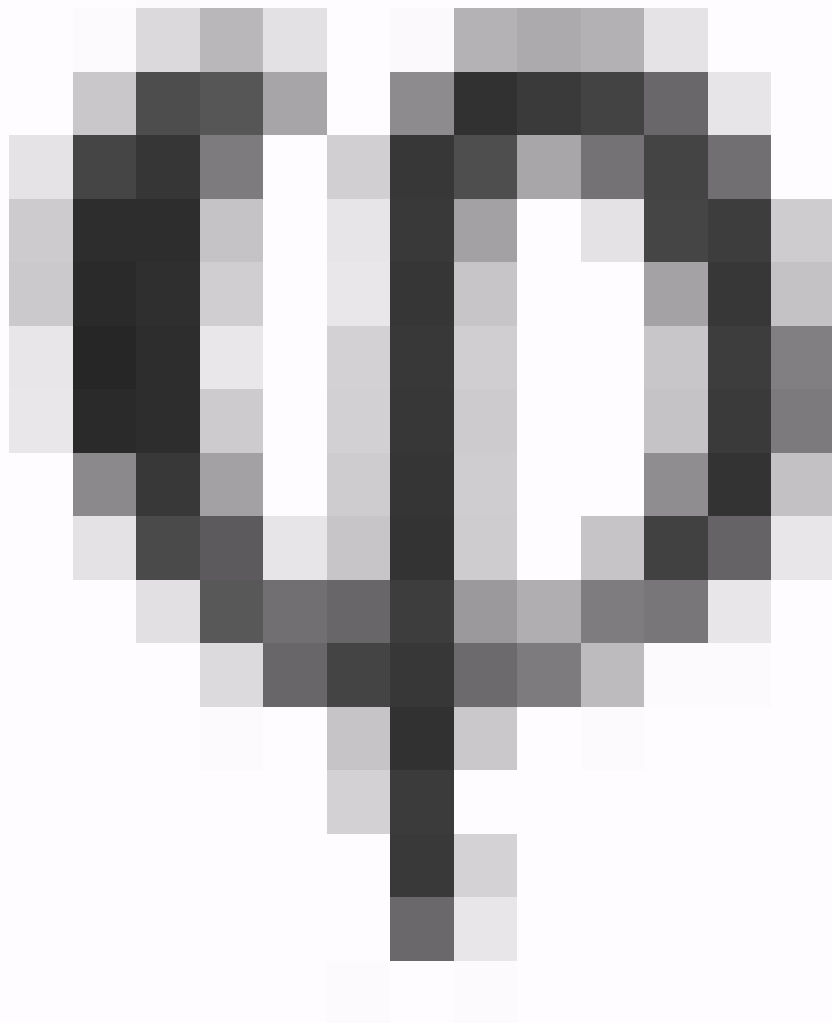

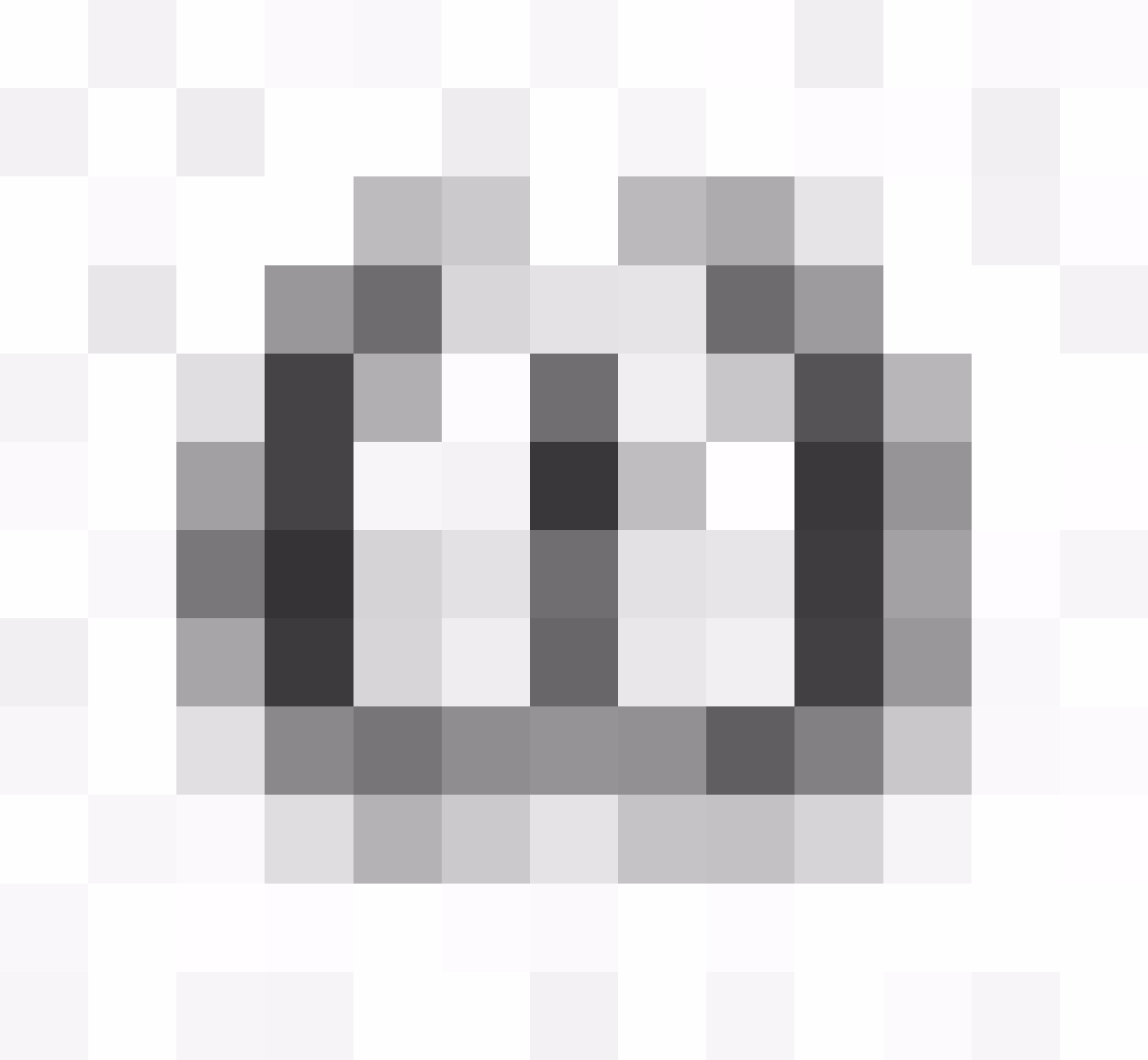

$$T = \frac{2\pi}{\omega}$$

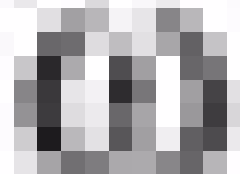
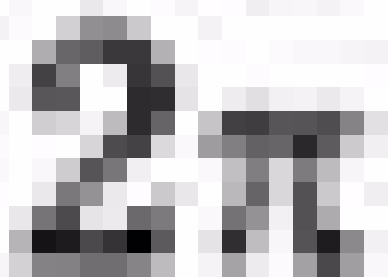
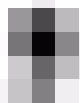

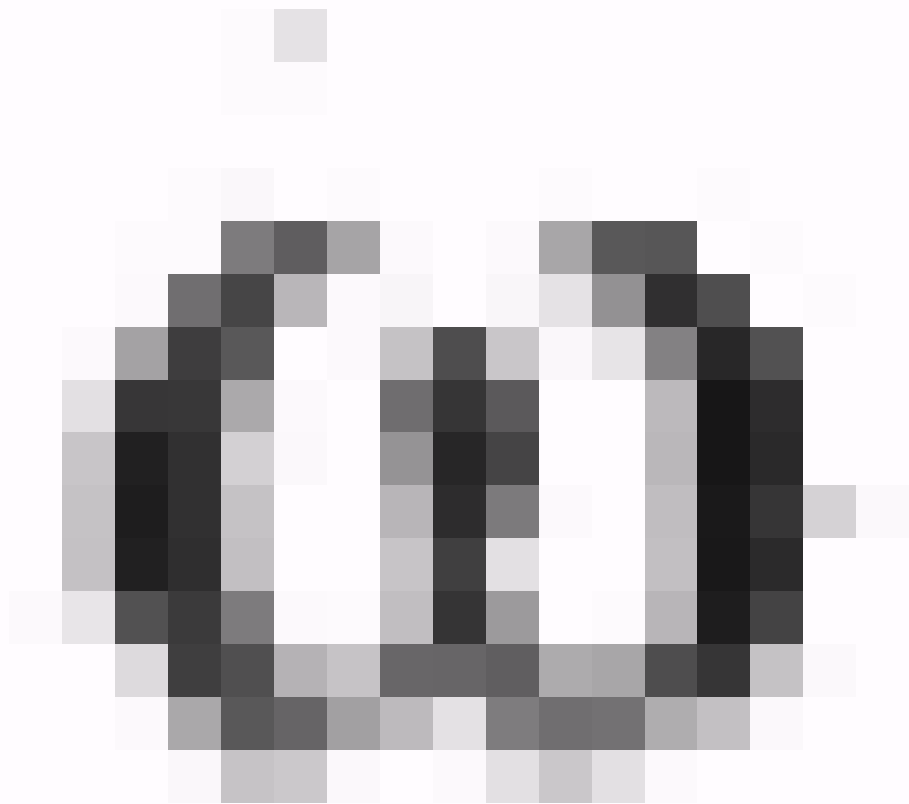

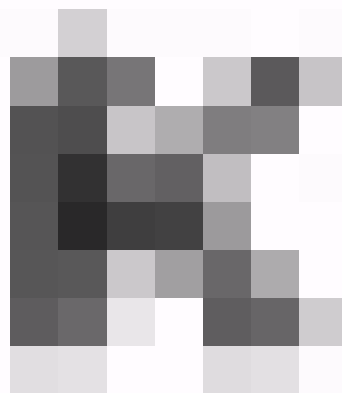
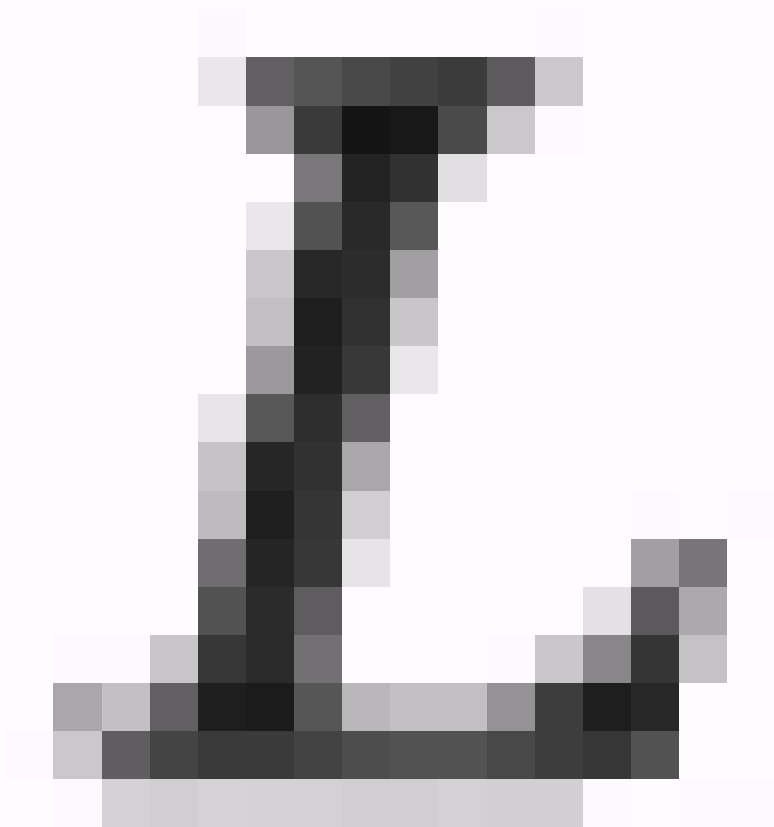

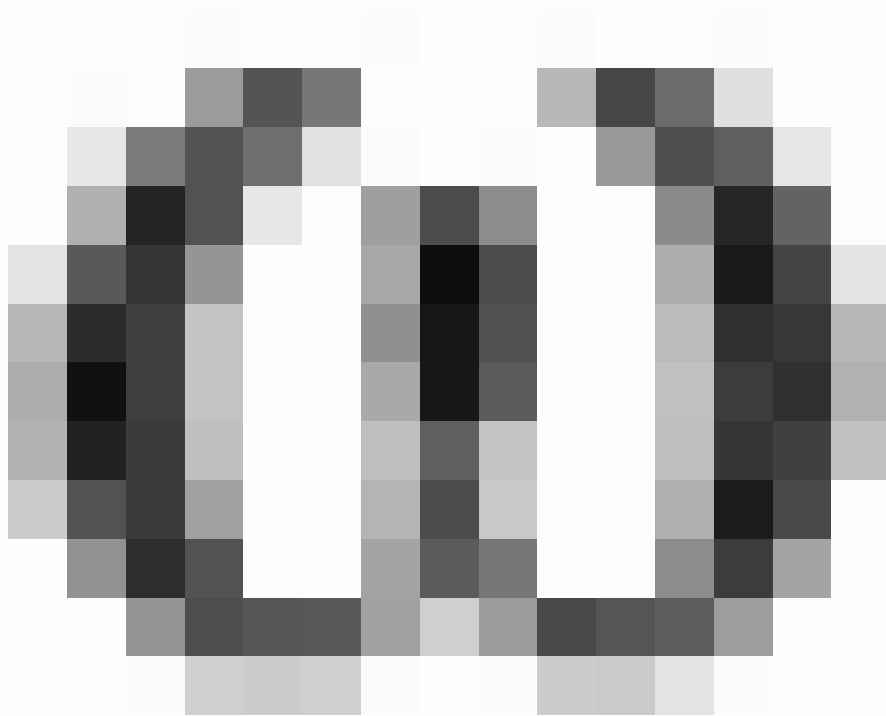



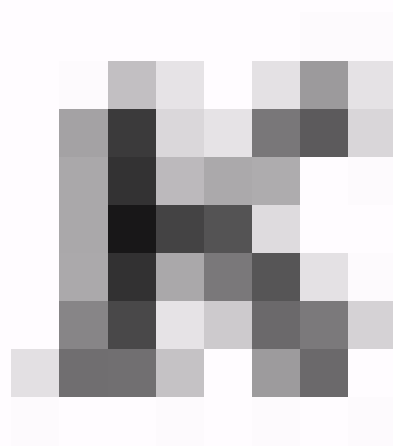
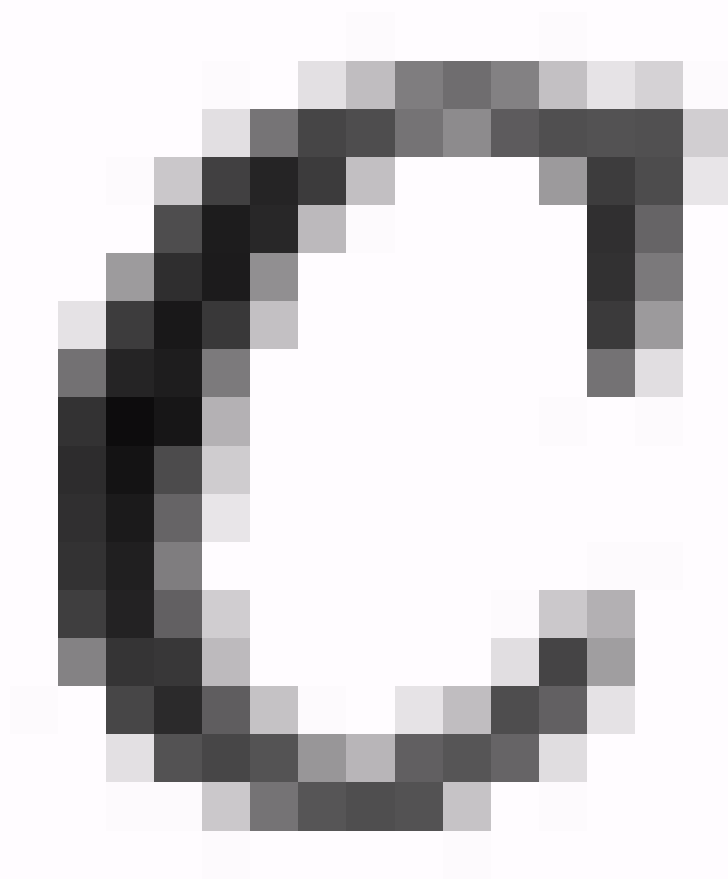





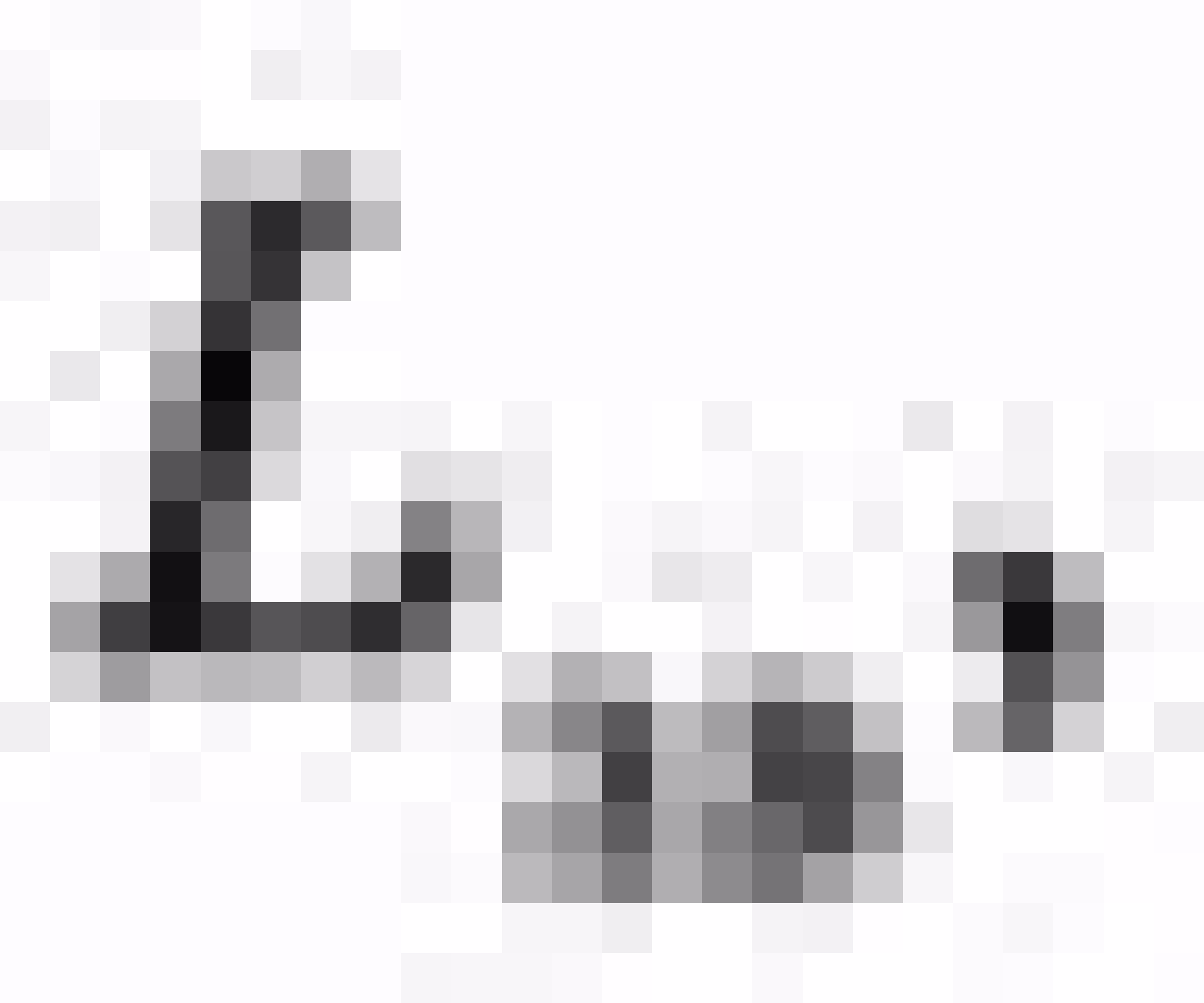

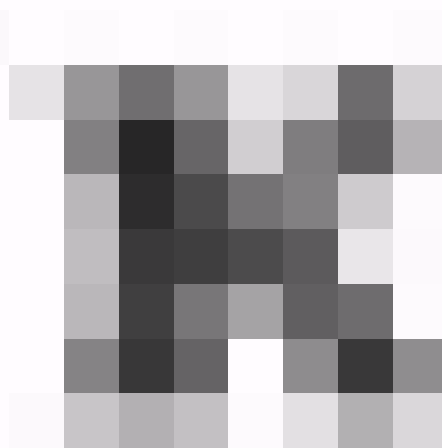
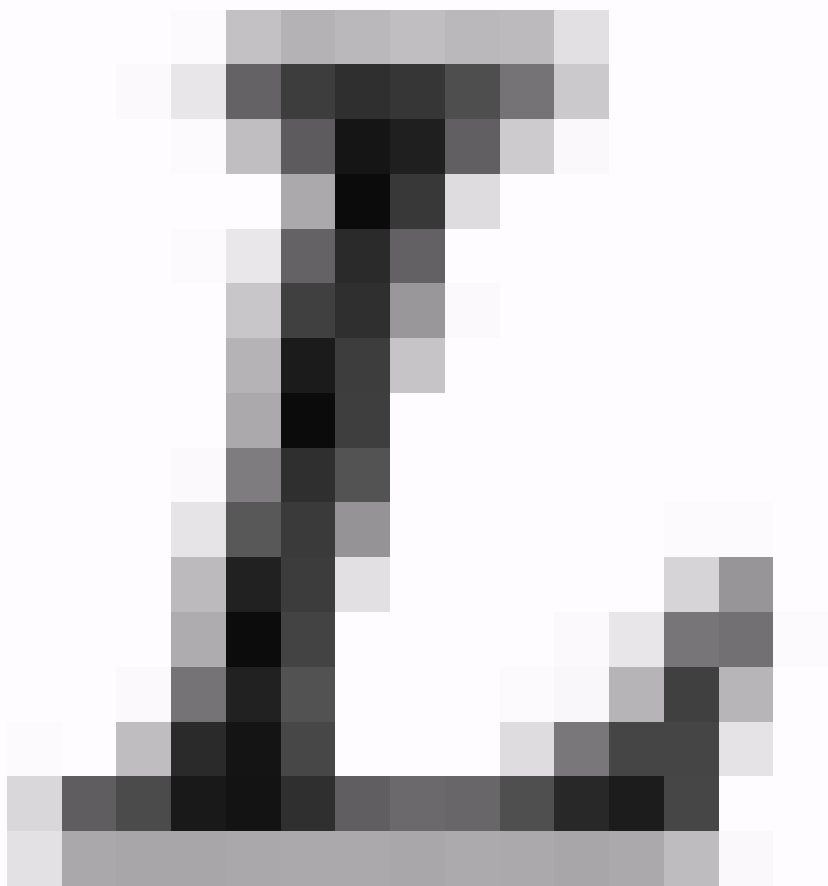

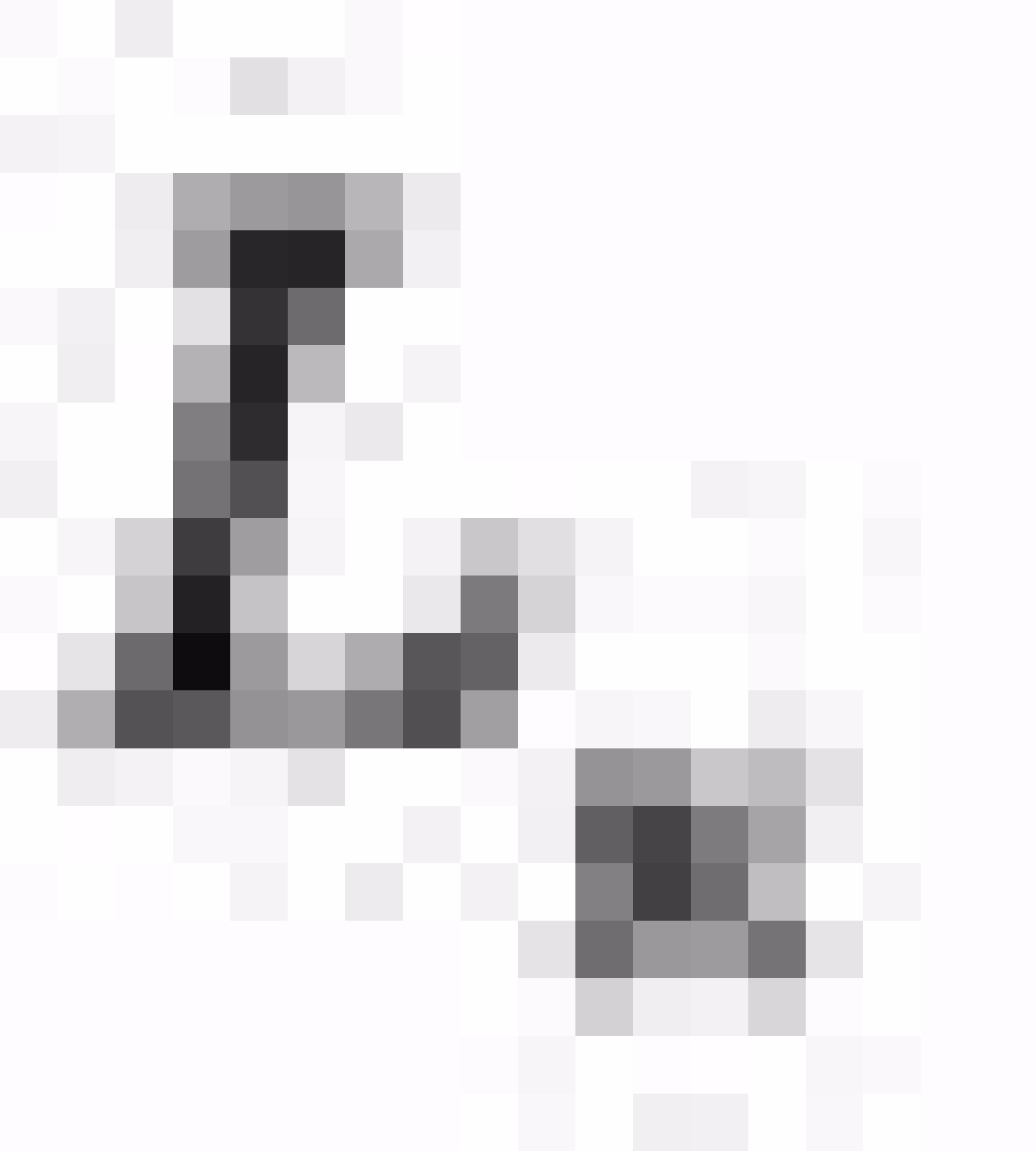

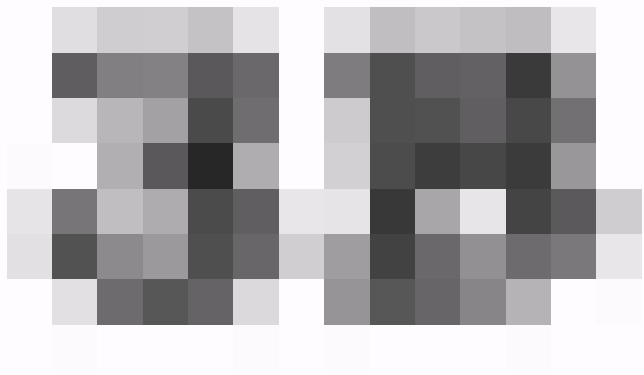
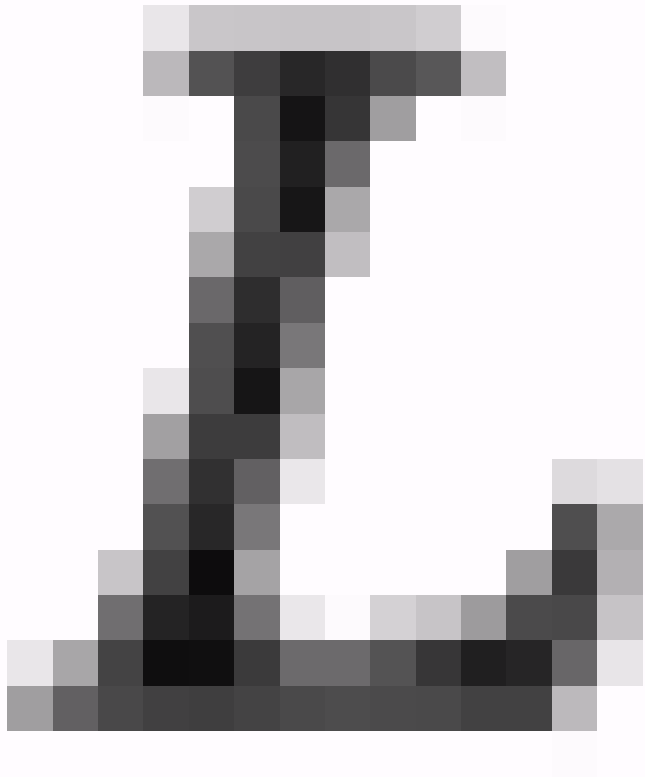



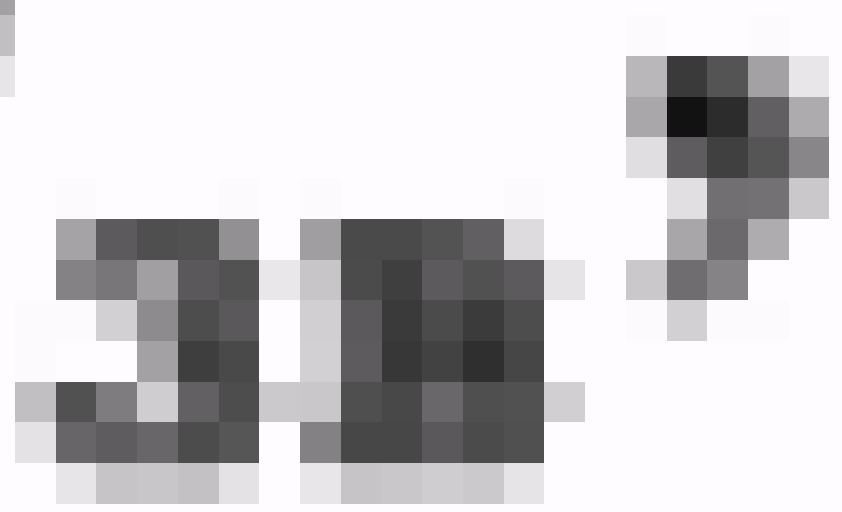
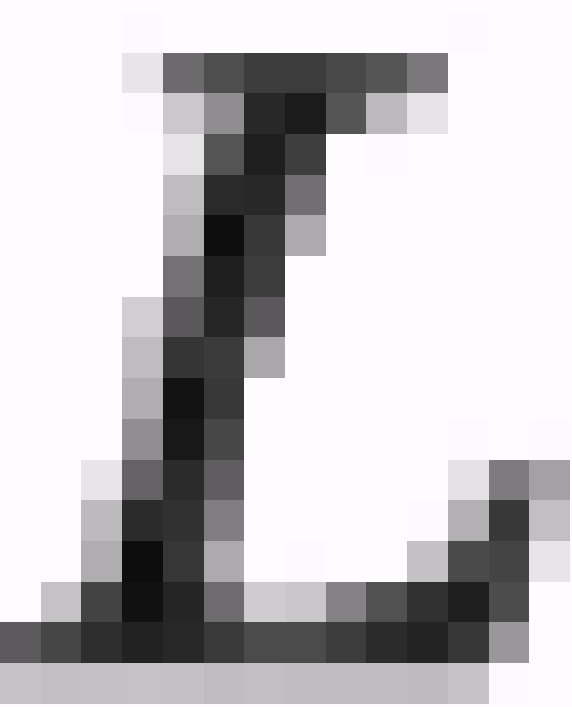

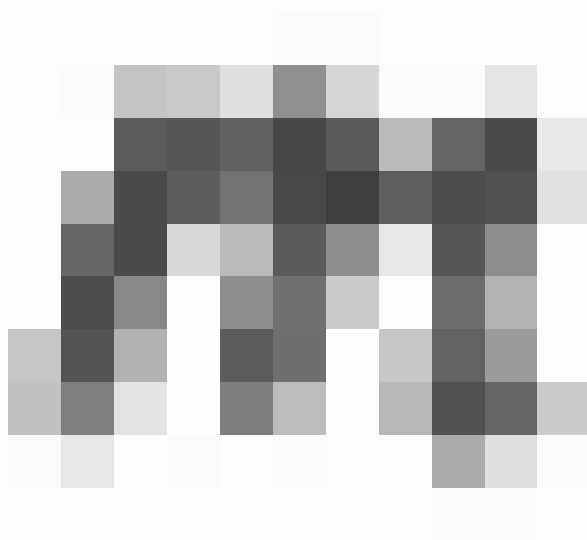
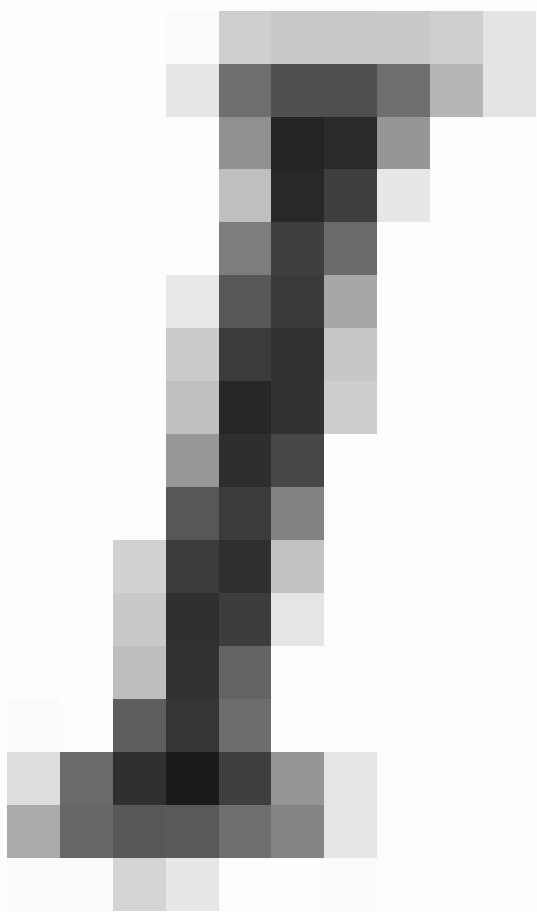



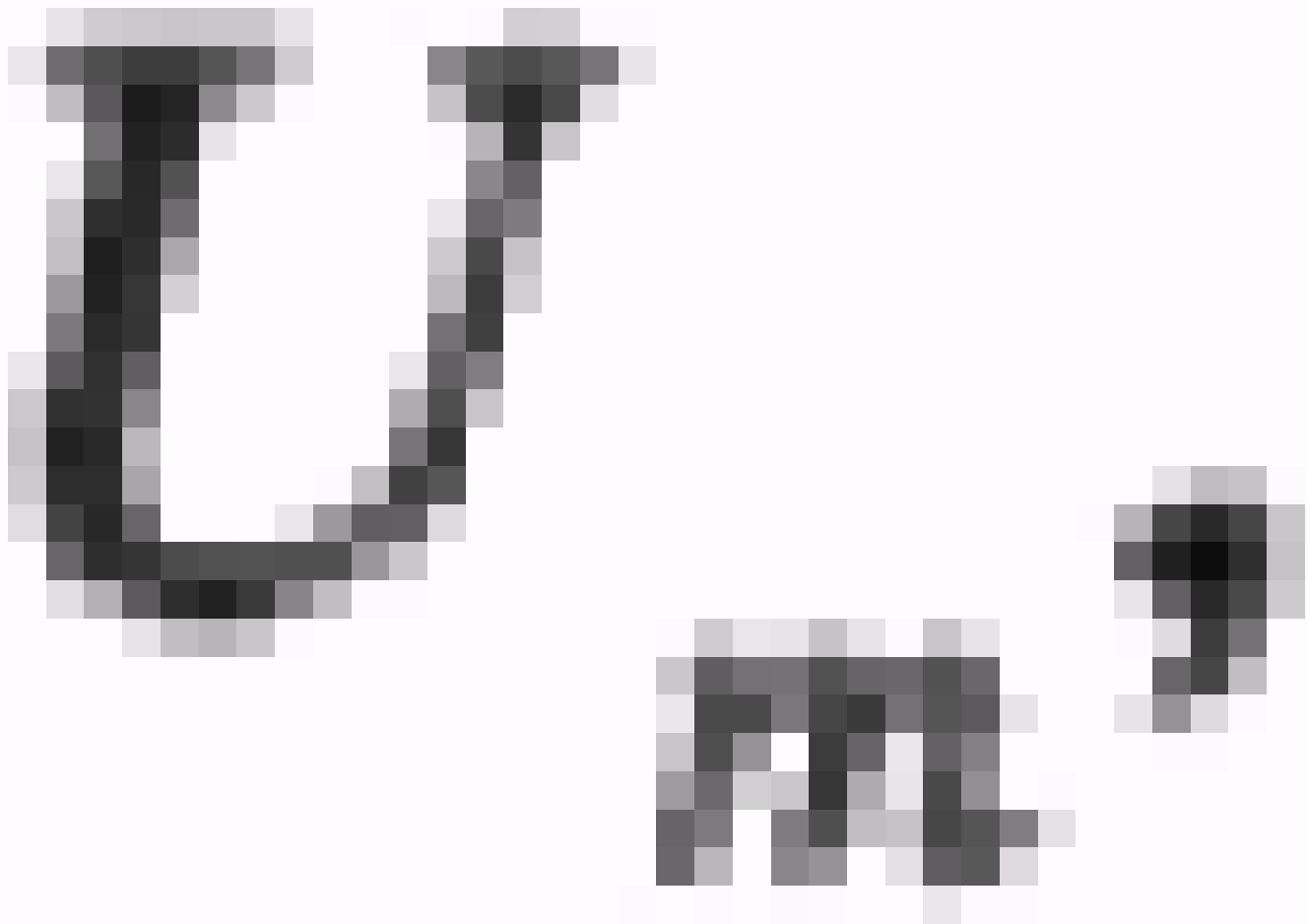

$v = U_m \cos \omega t$ (50.1)

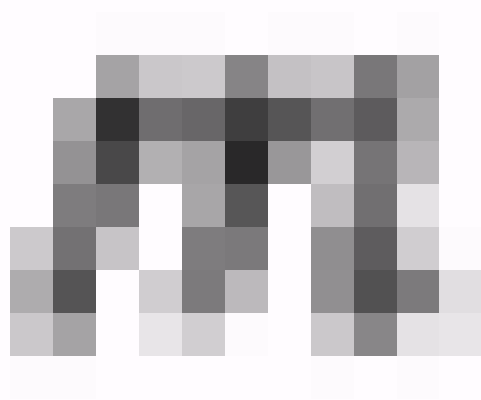
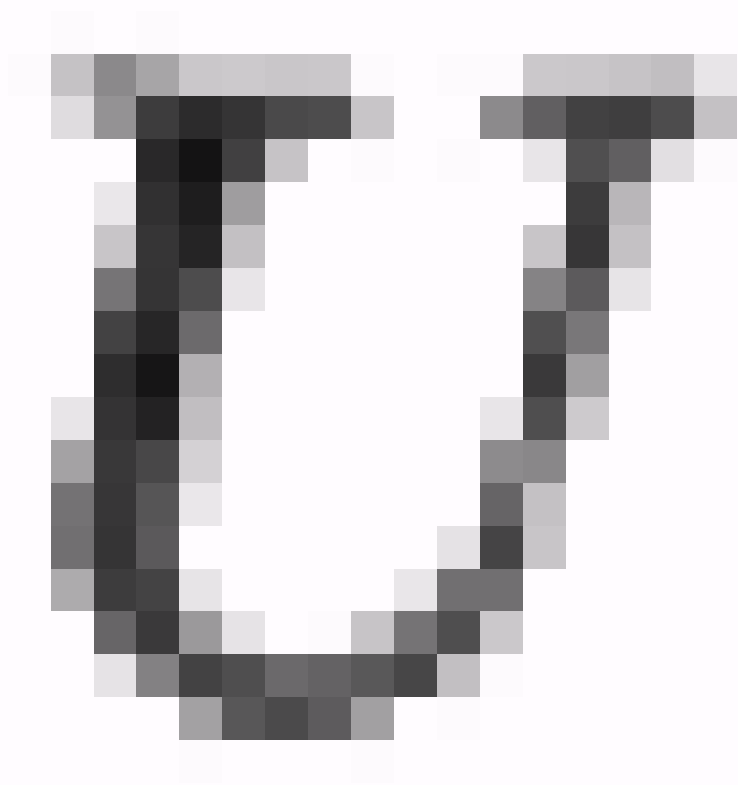

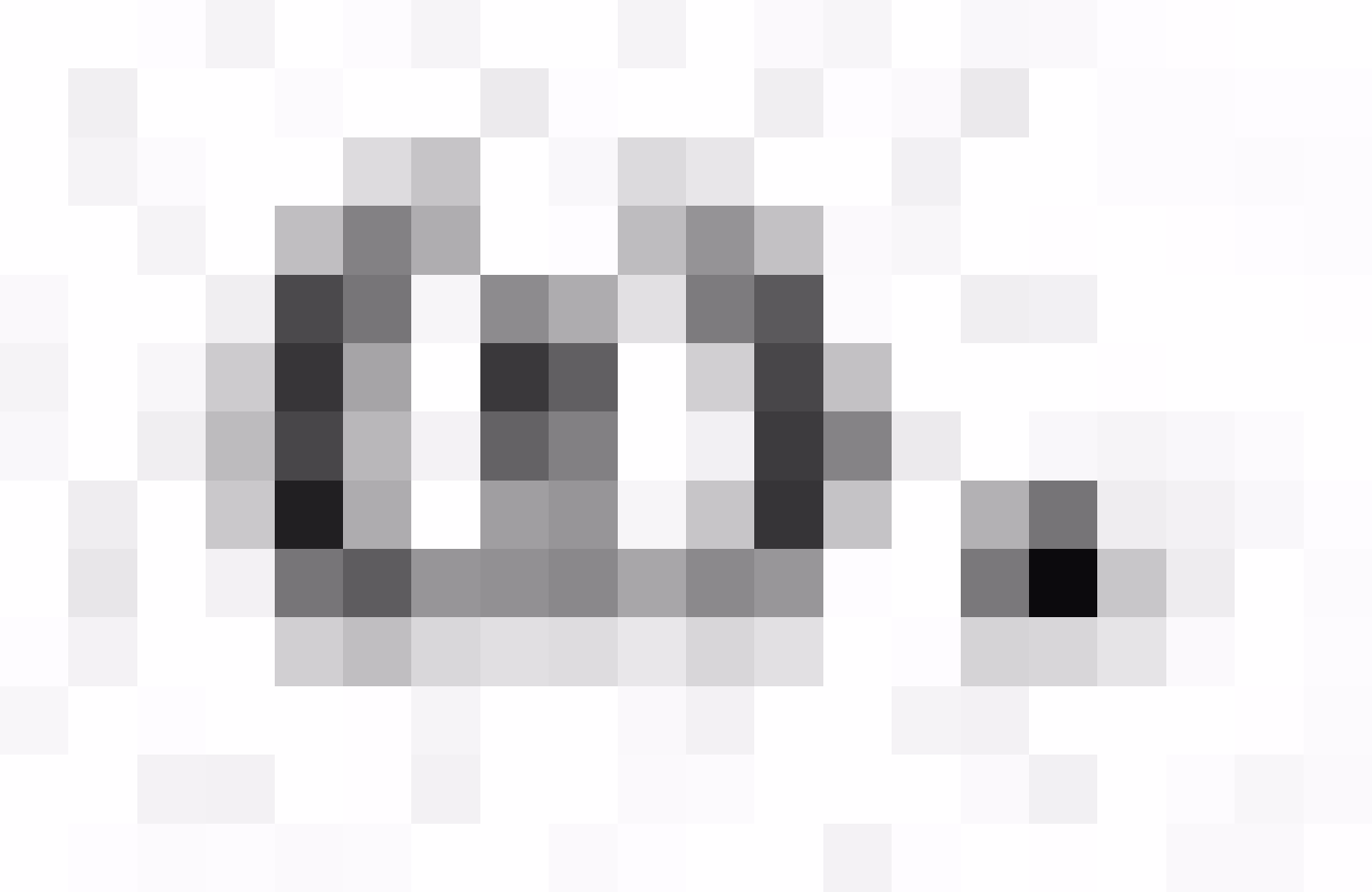

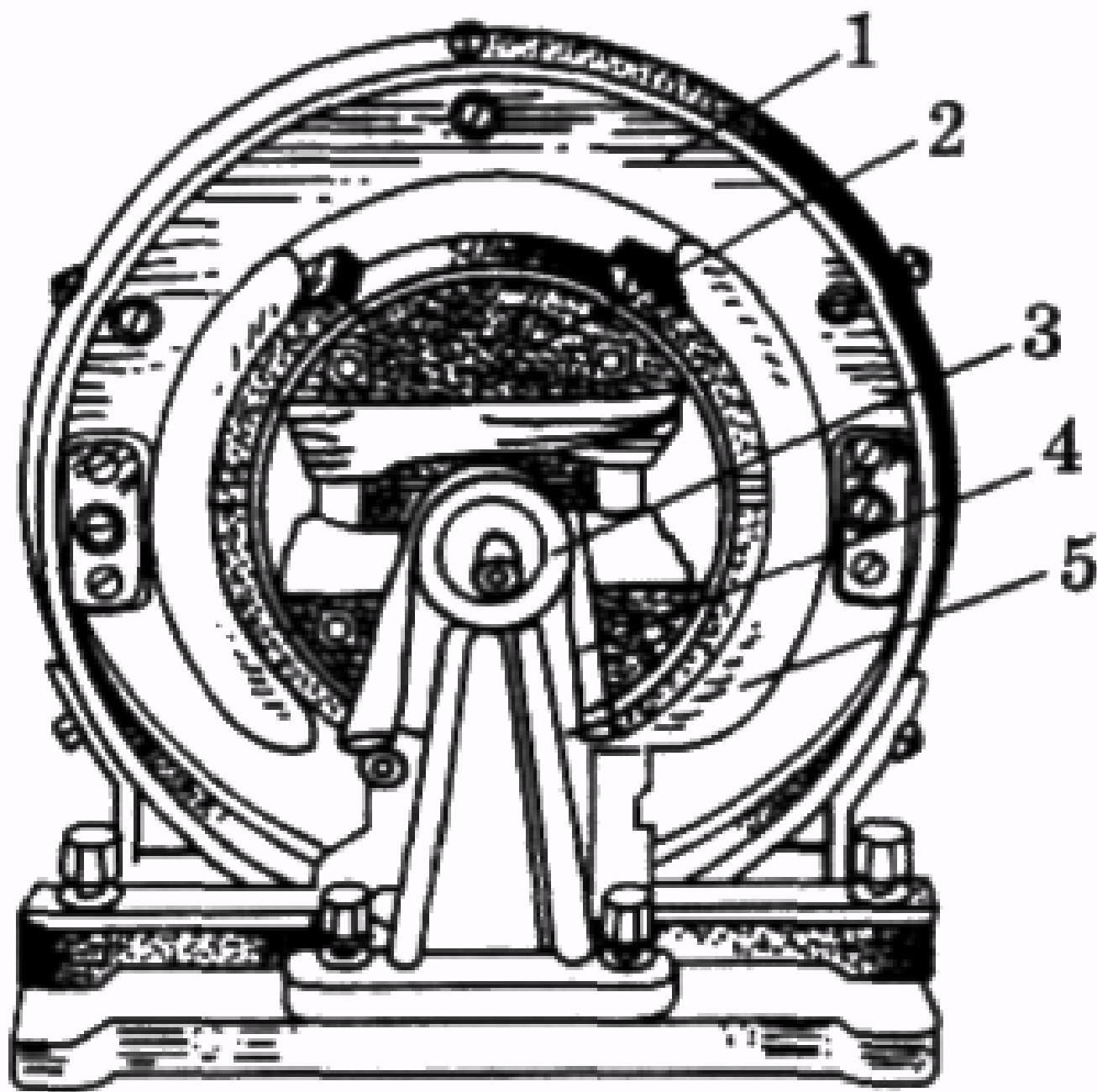

Мал. 2.159

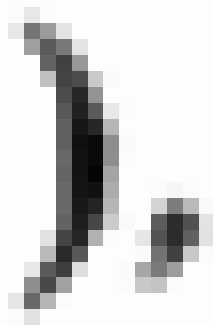
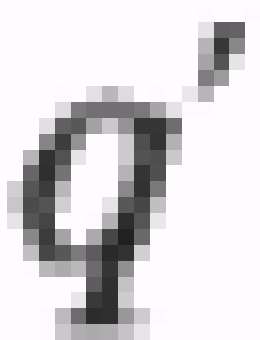

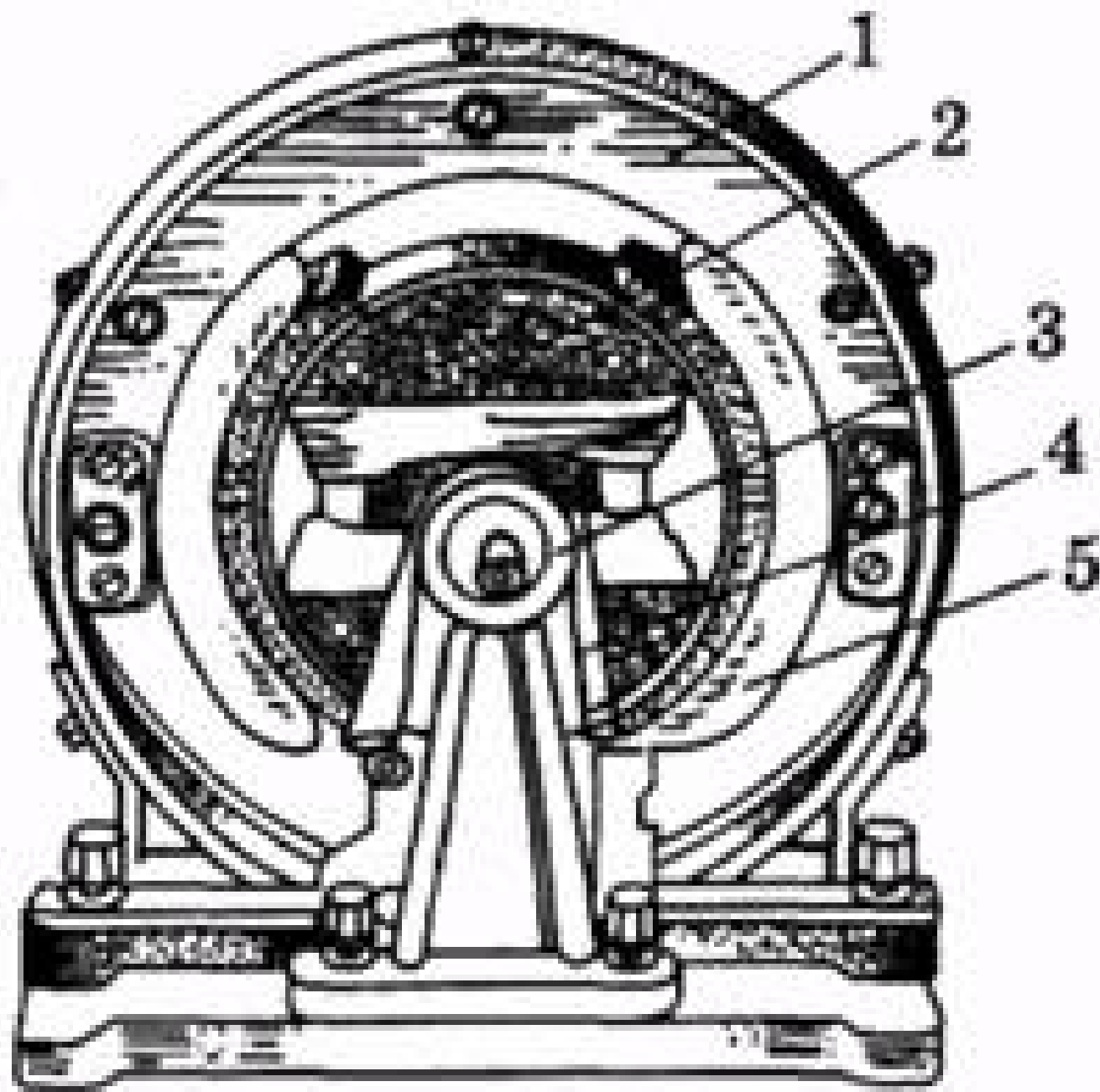

Мал. 2.159

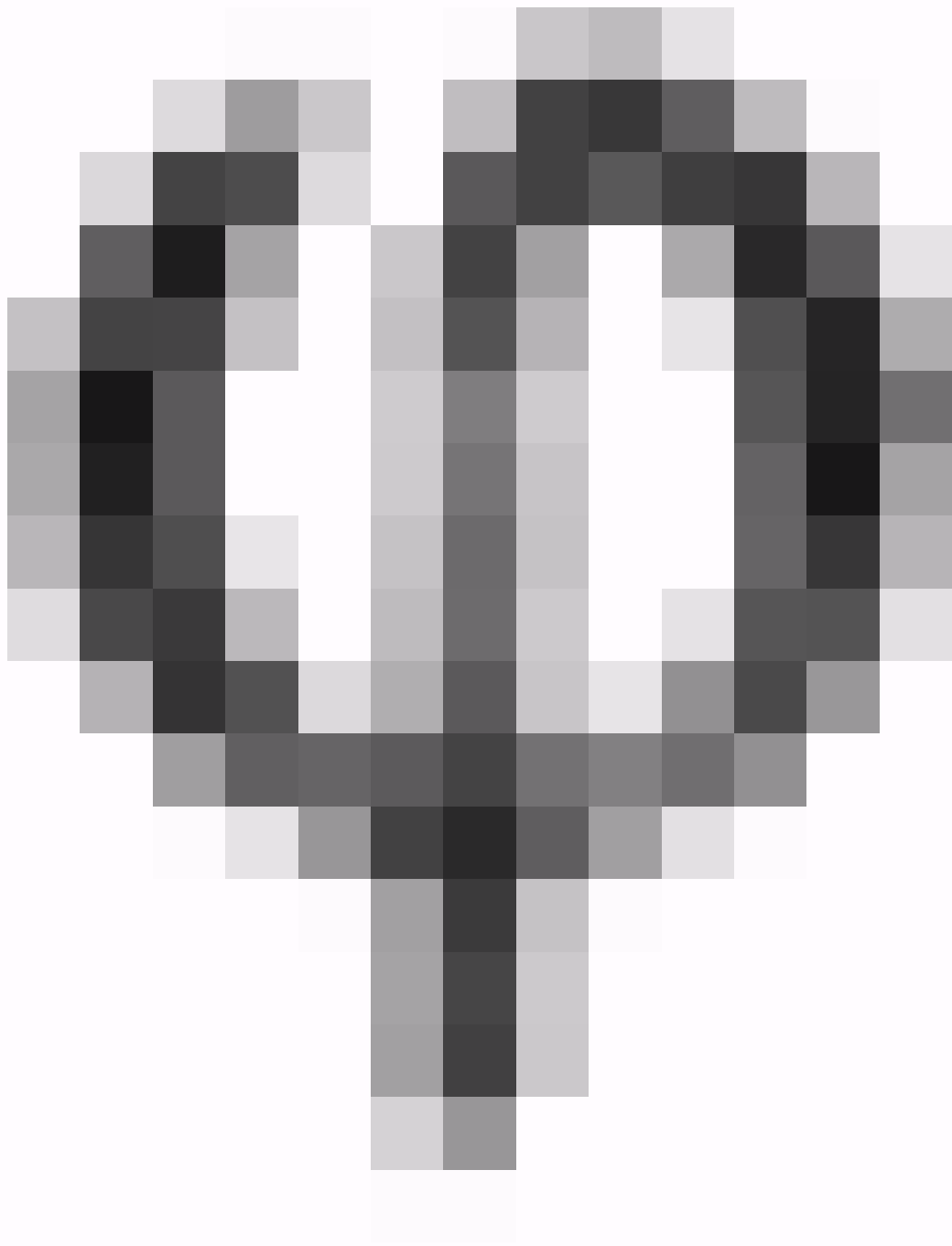

$$i = -V_m \omega C \sin \omega t = V_m \omega C \cos \left(\omega t + \frac{\pi}{2} \right) \quad (50.3).$$

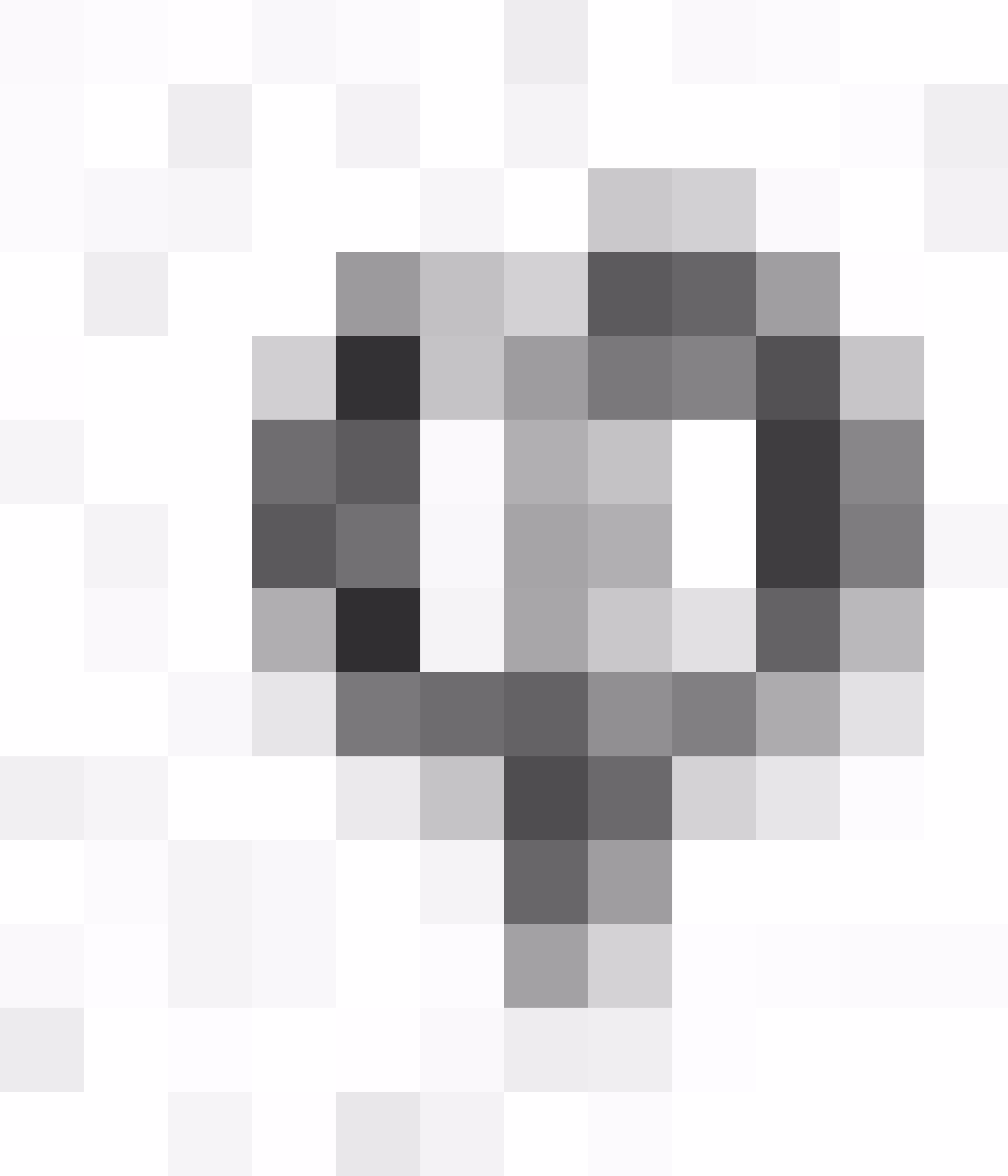

$\Phi = BS \phi$ (40.1)

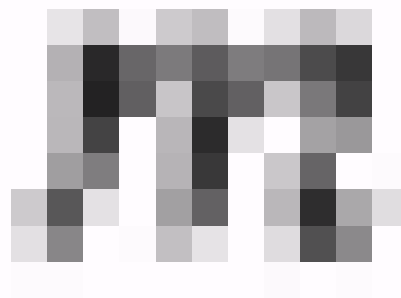
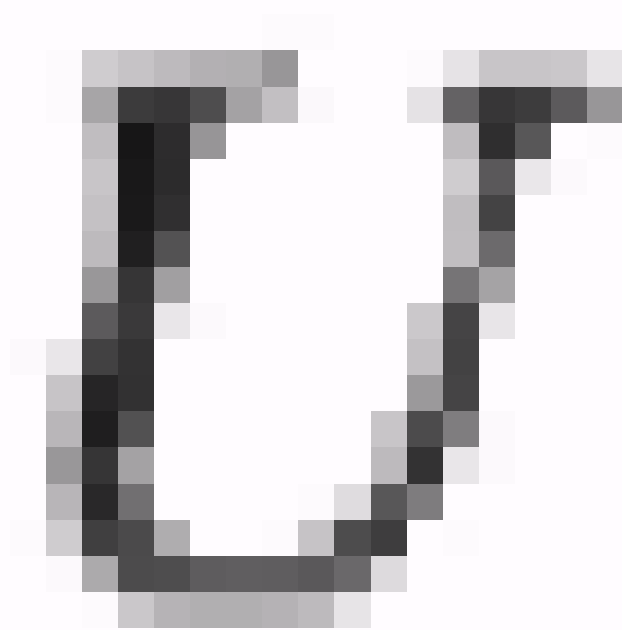

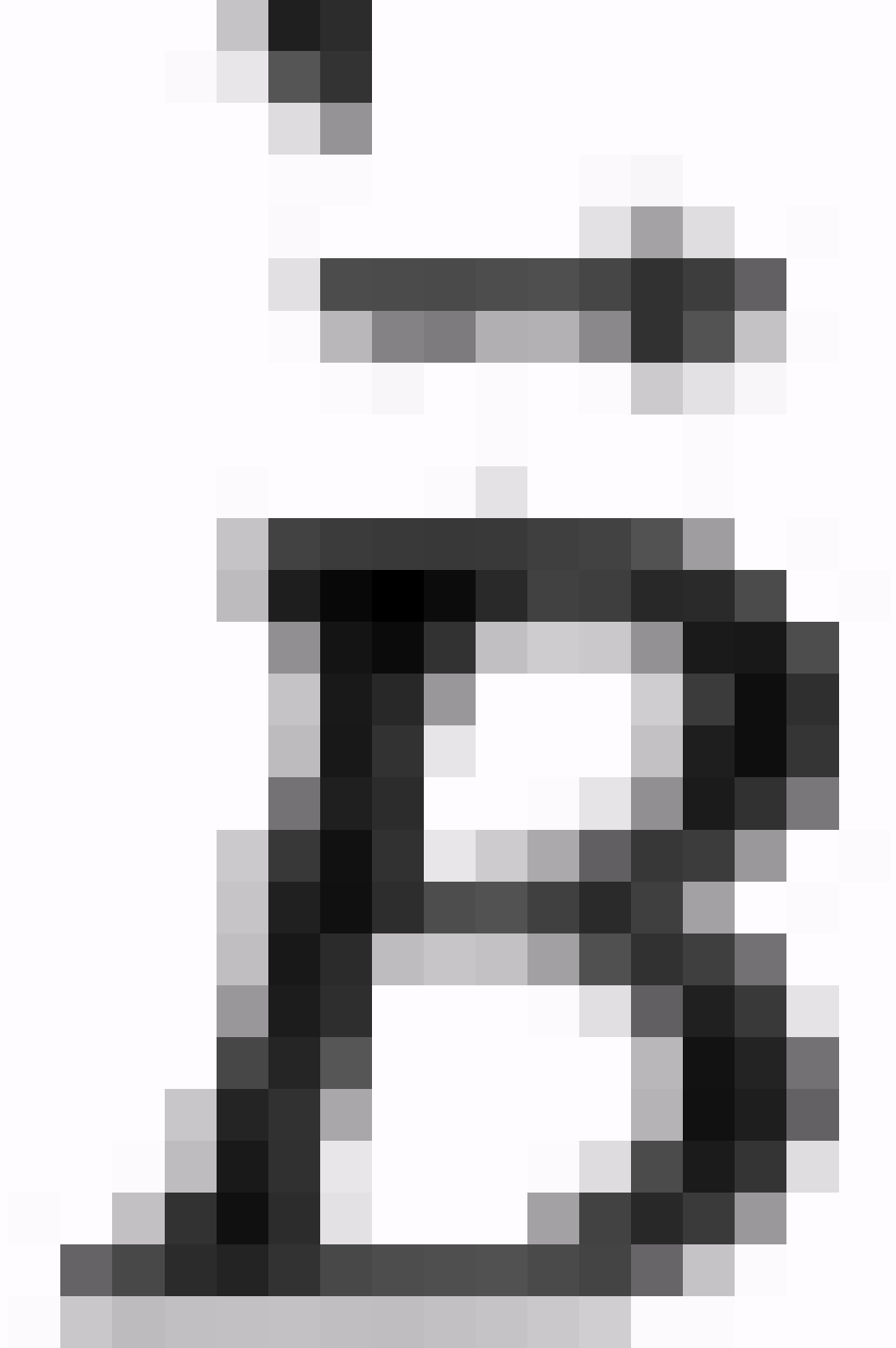

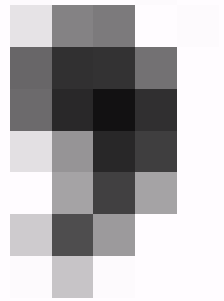
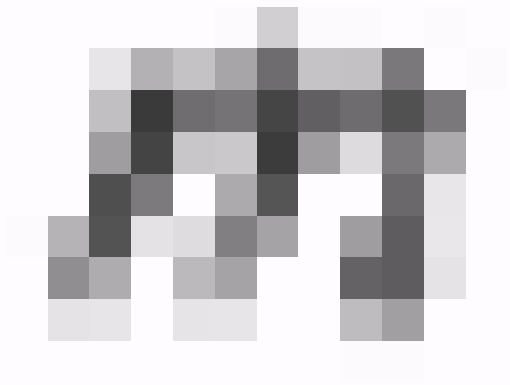
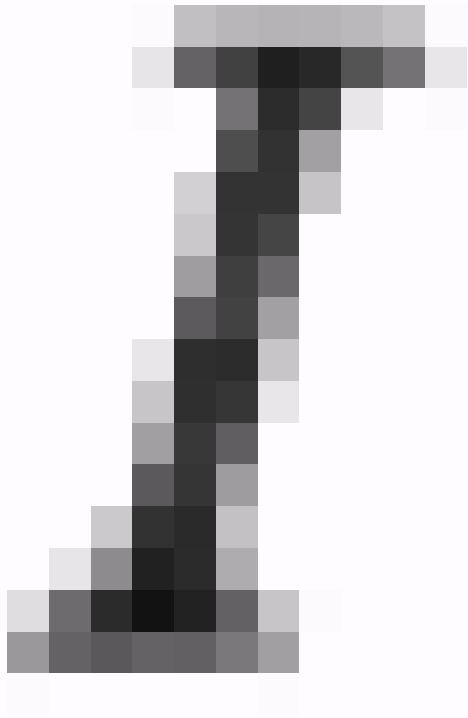

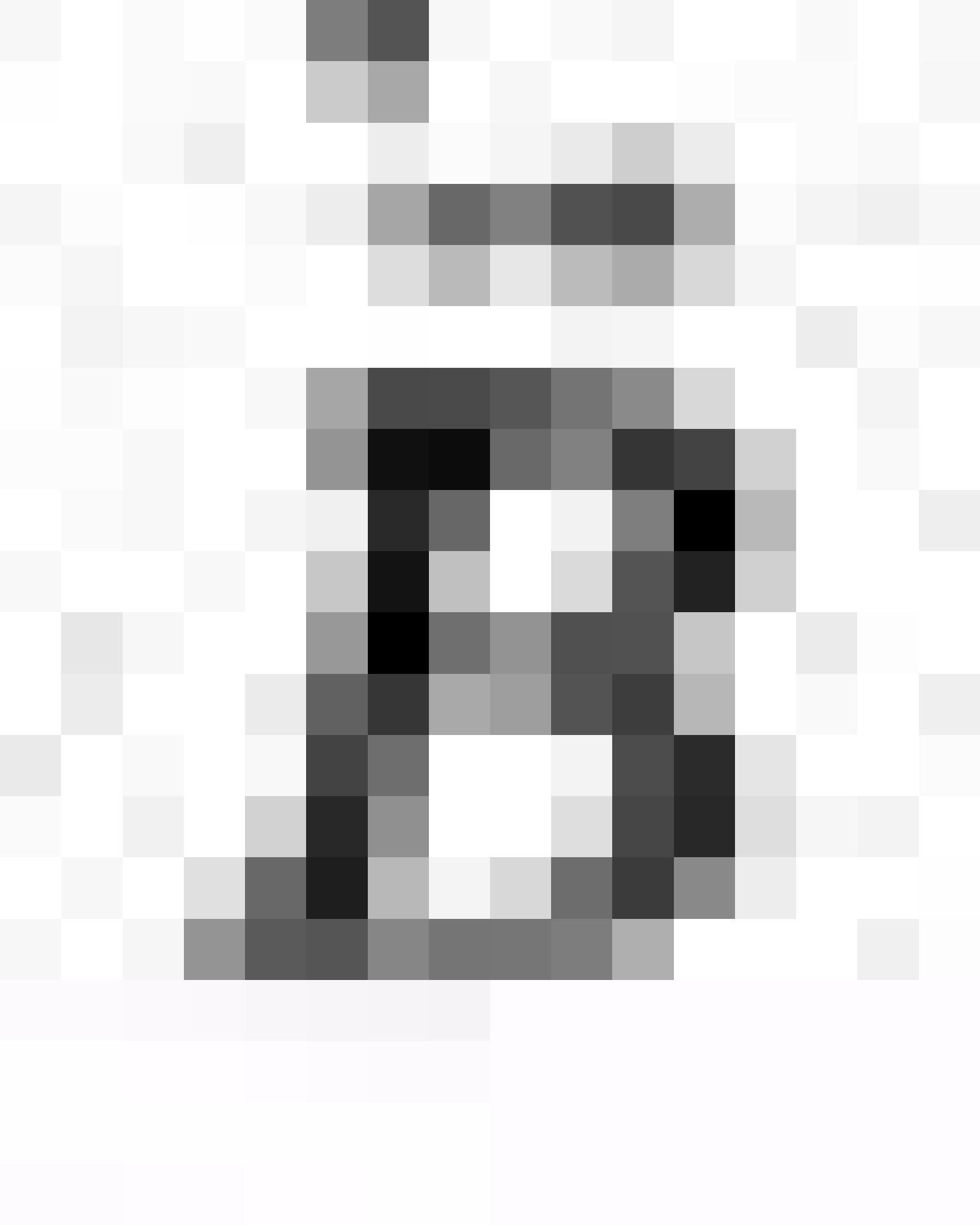

Im

=

V_{max} C

(50.4)

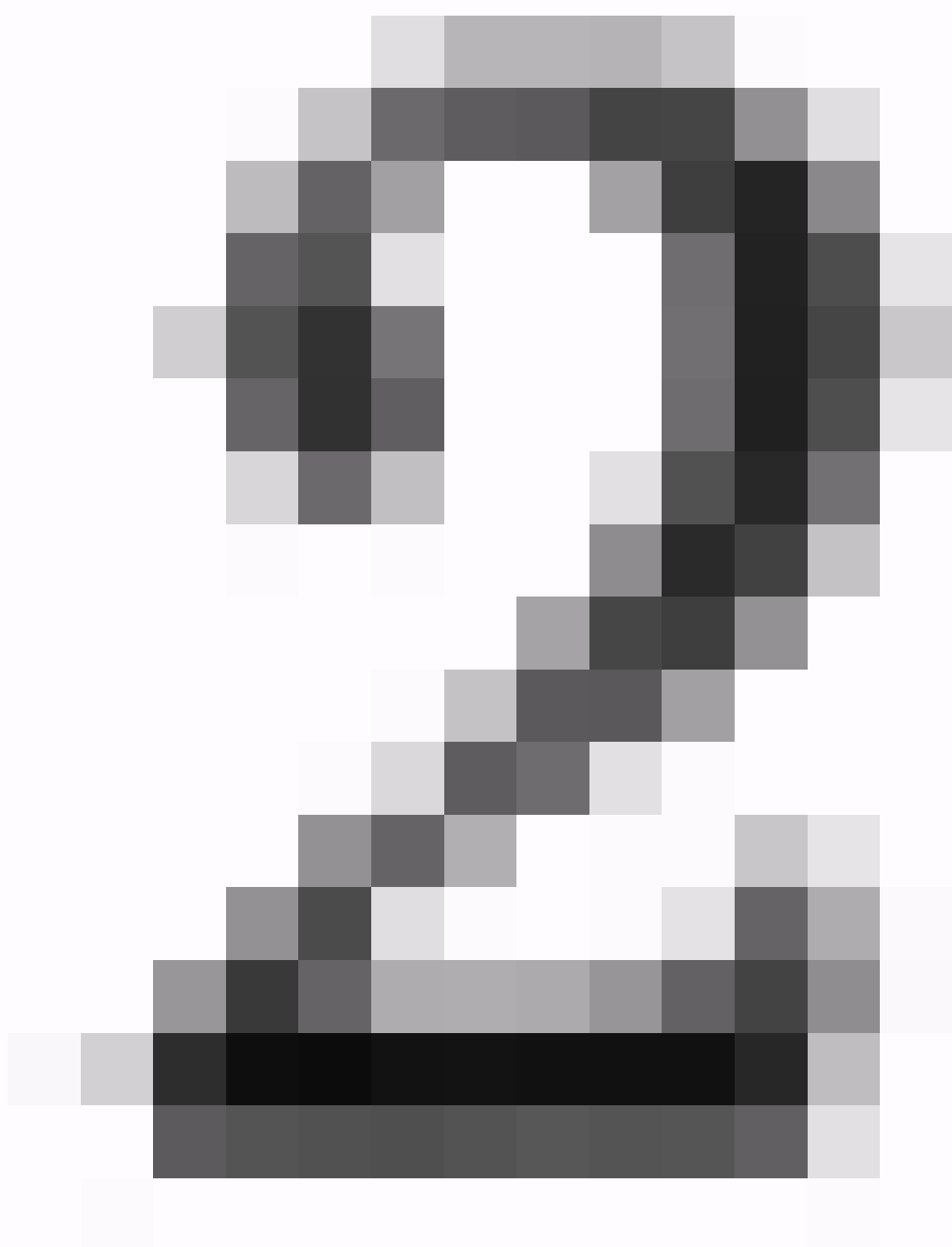
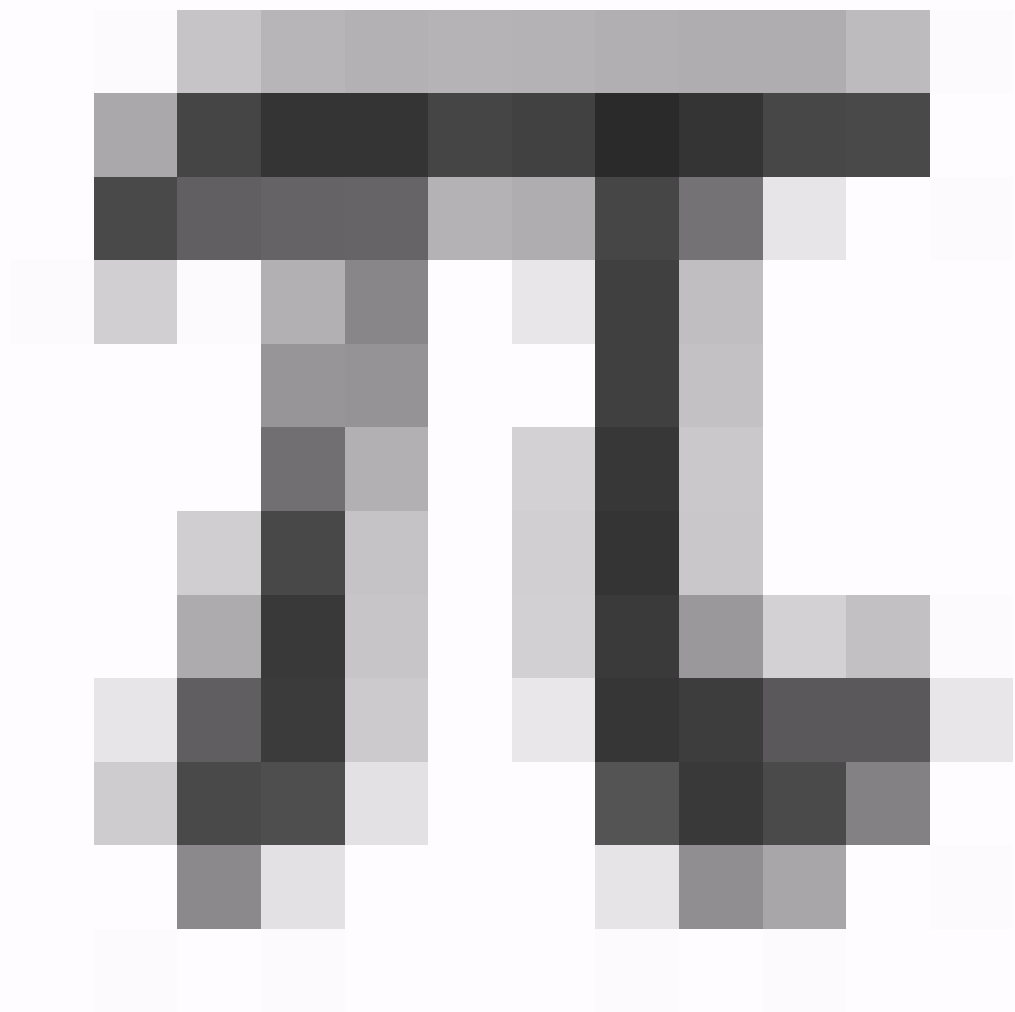

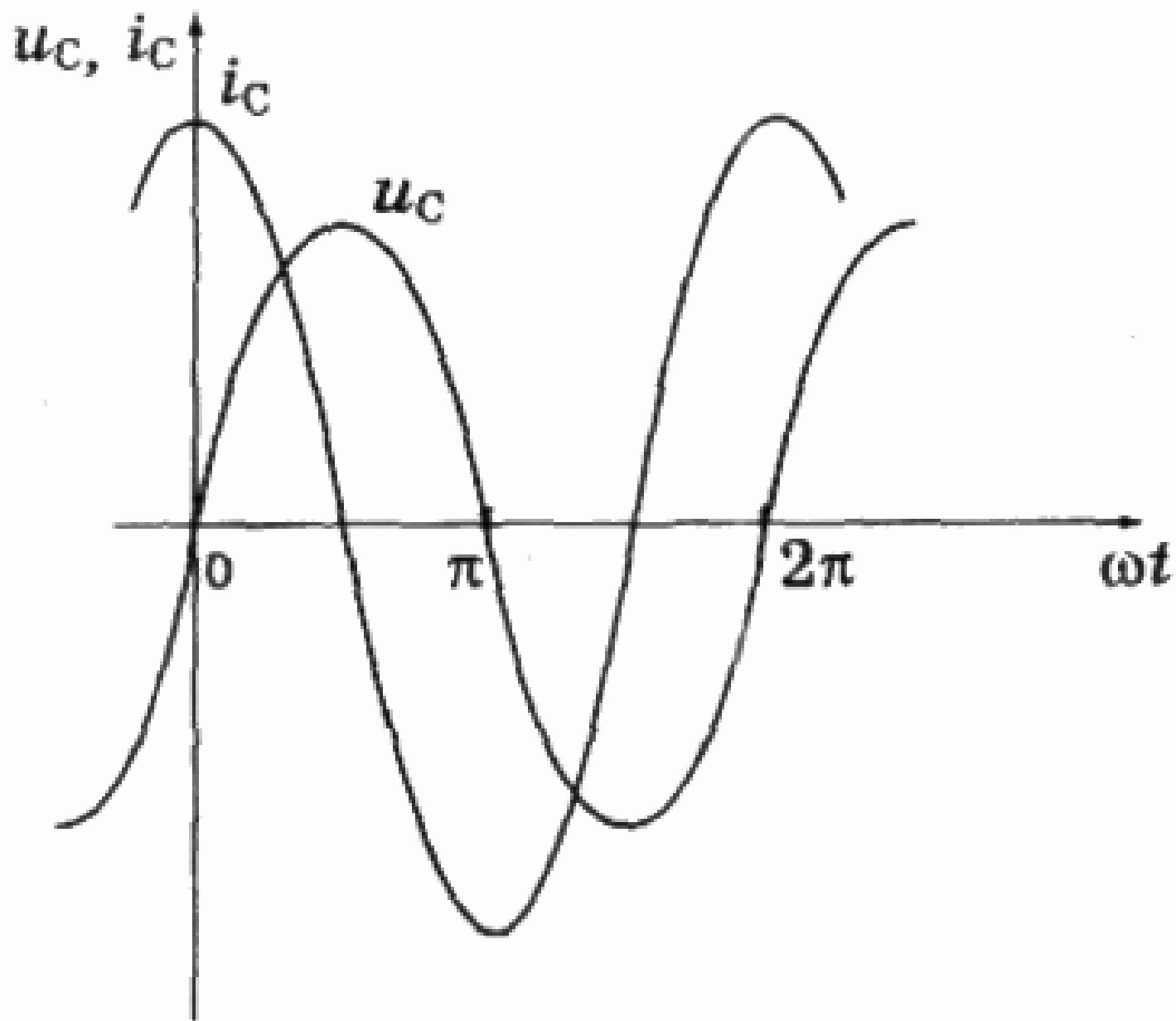

Мал. 2.161

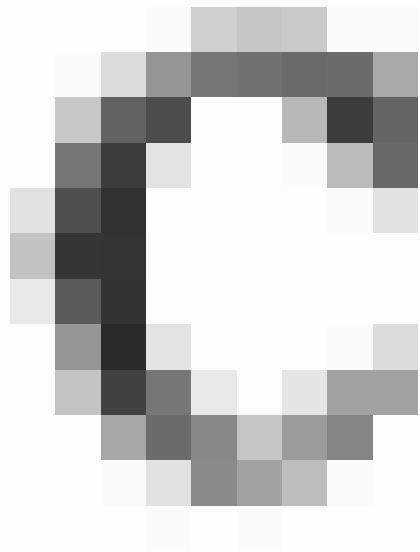
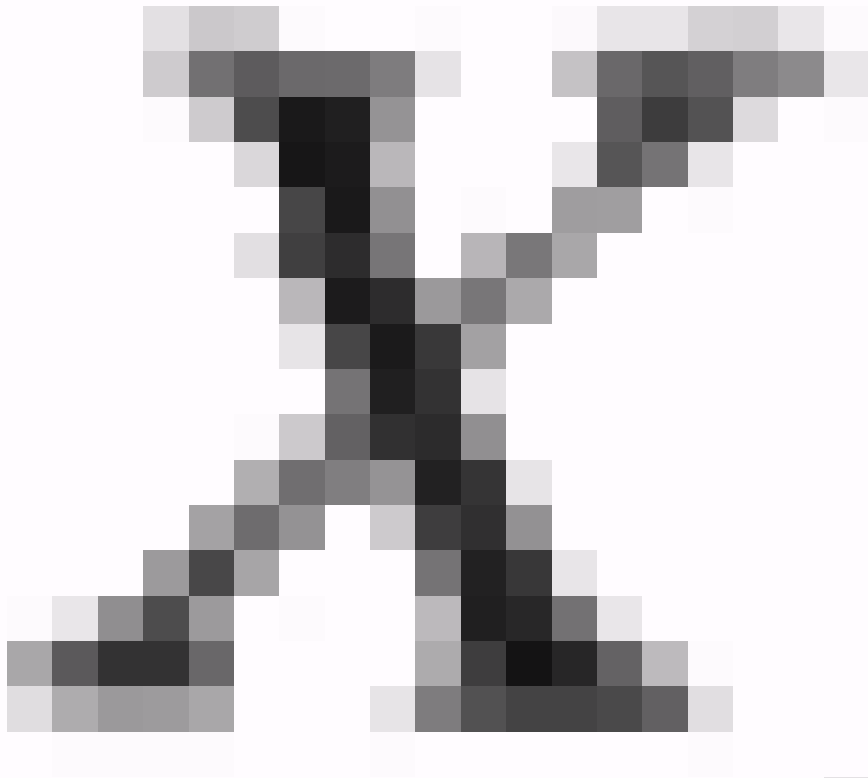

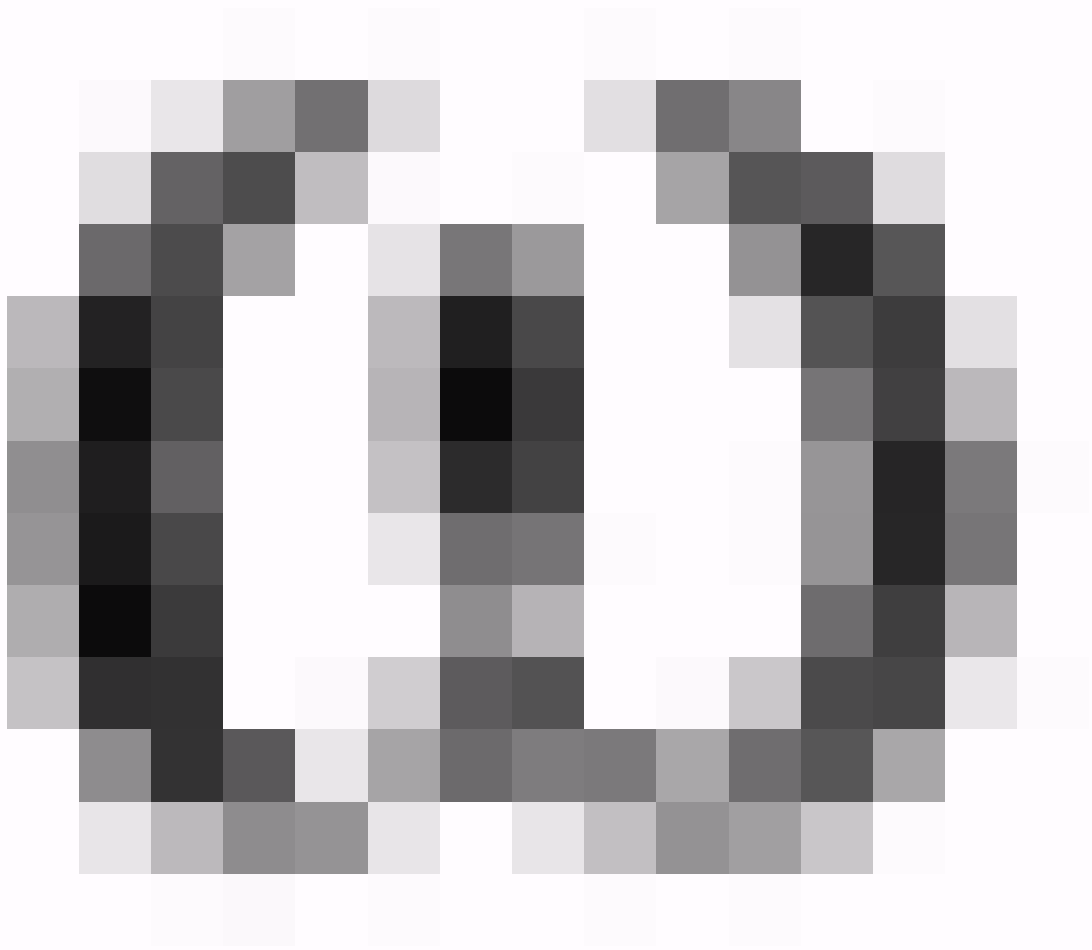

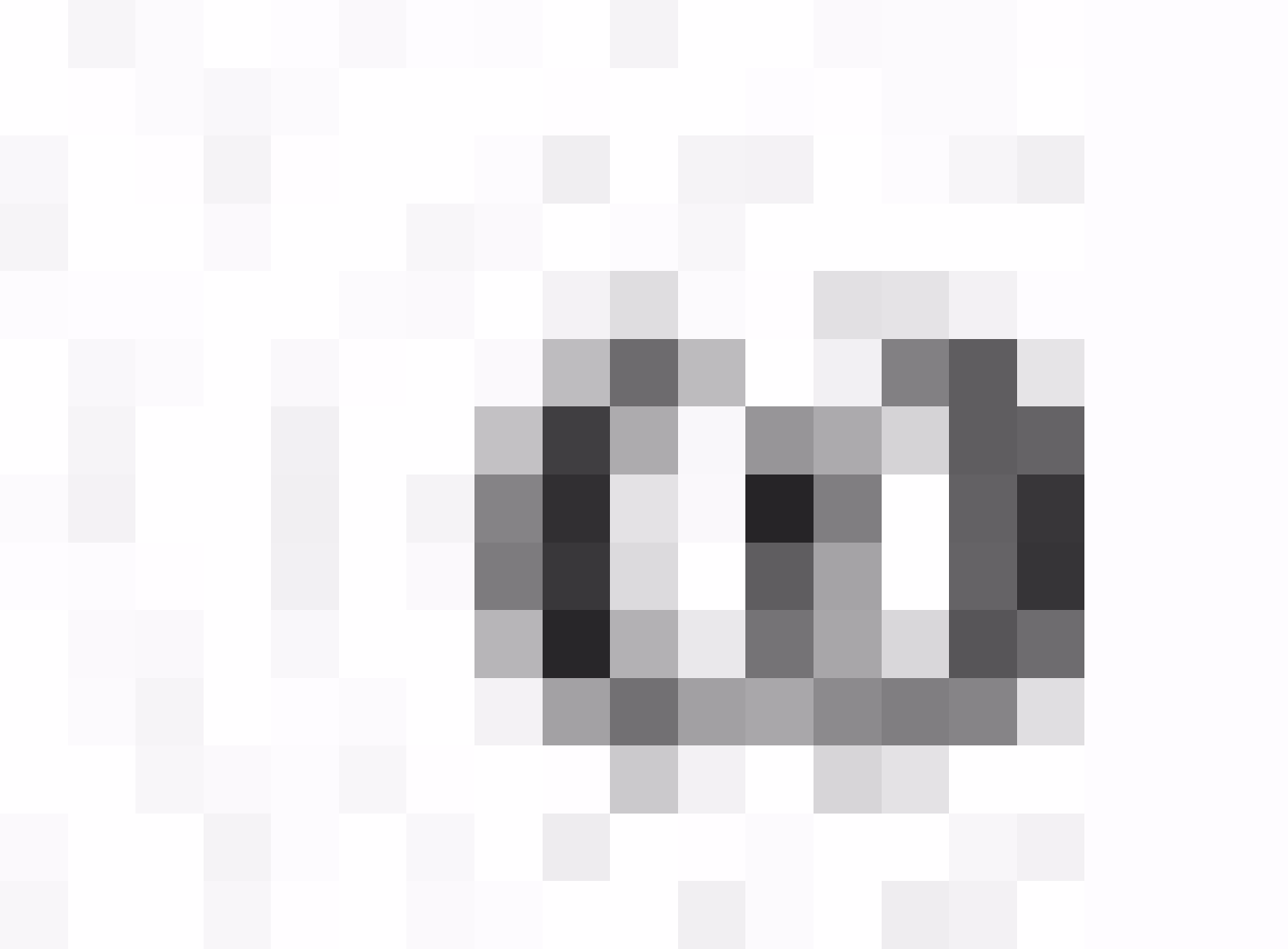

$$X_c = \frac{1}{\omega C} \quad (50.5)$$

$$I_m = \frac{U_m}{X_c} \quad (50.6)$$

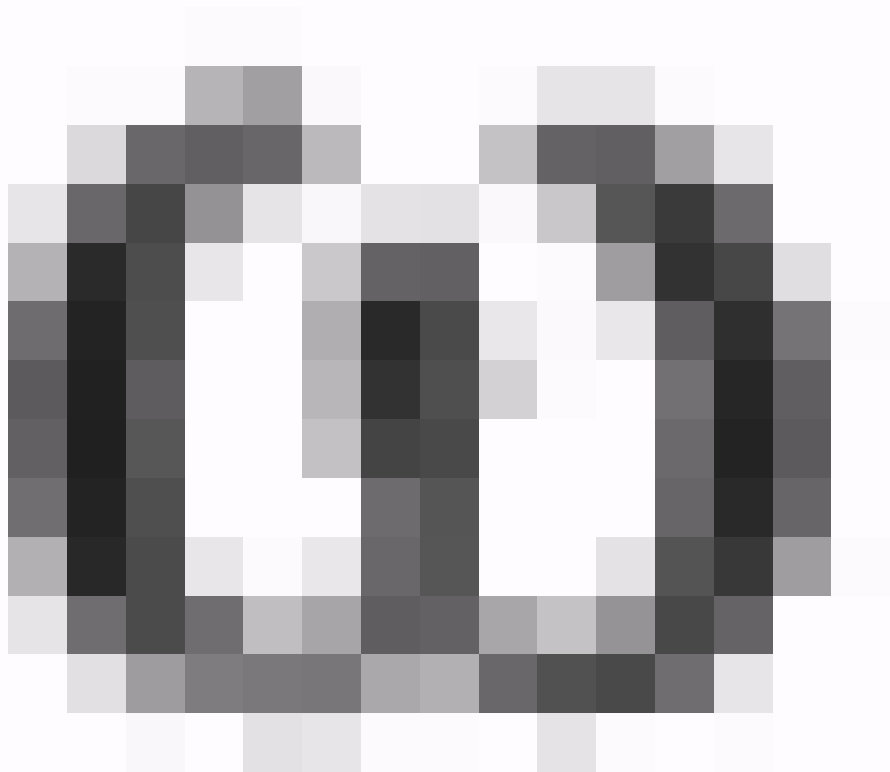

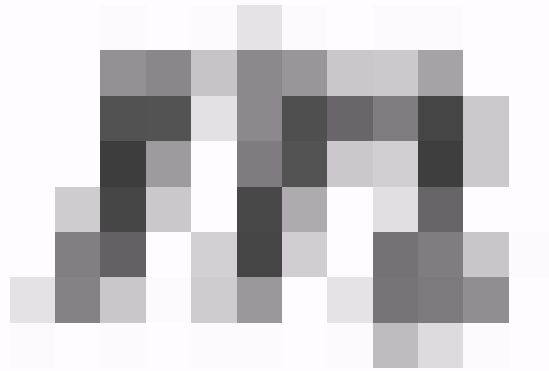
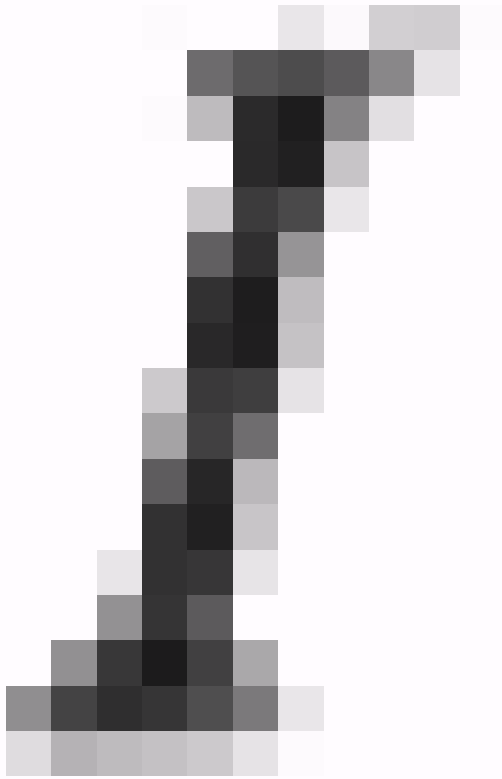

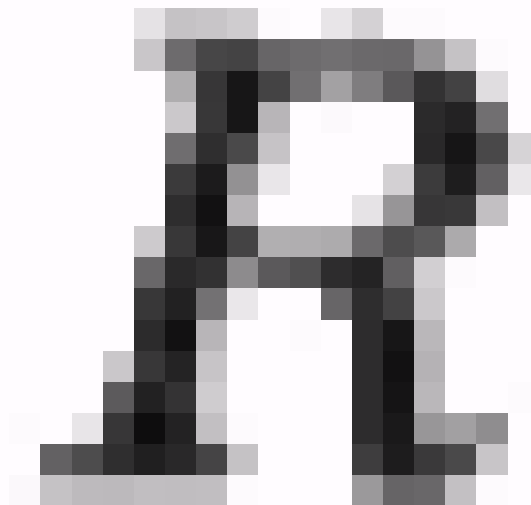
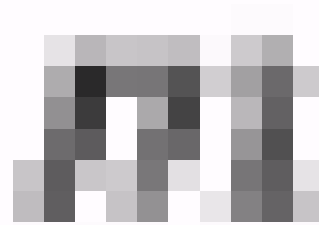
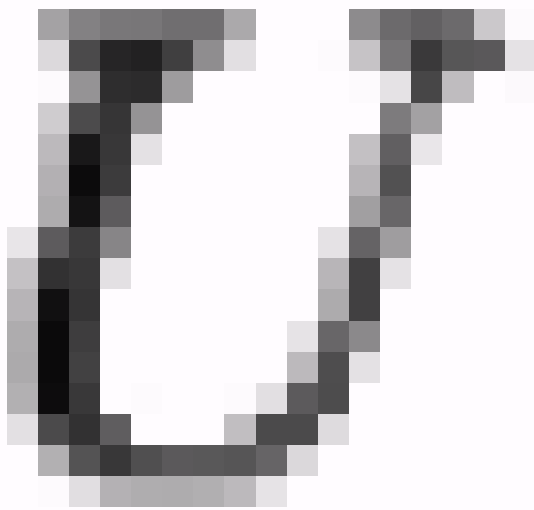

I

A

<

U

A

—

.

R

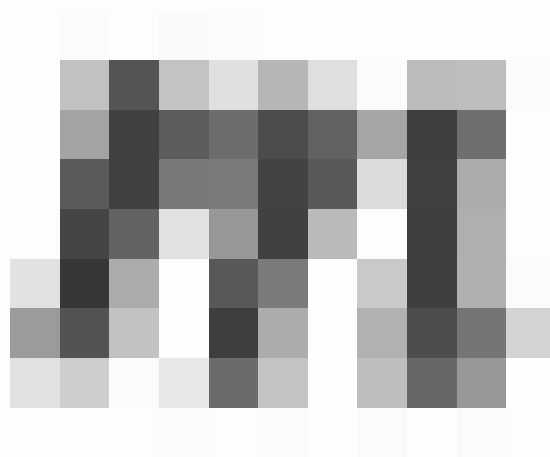
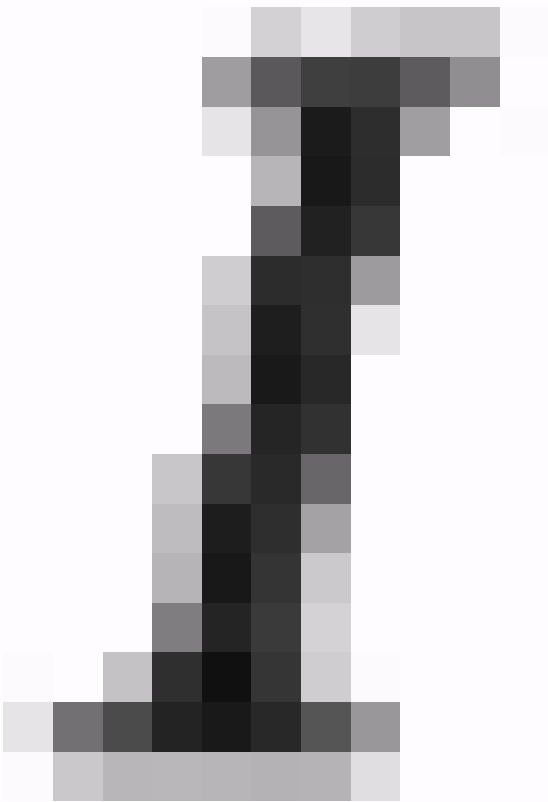

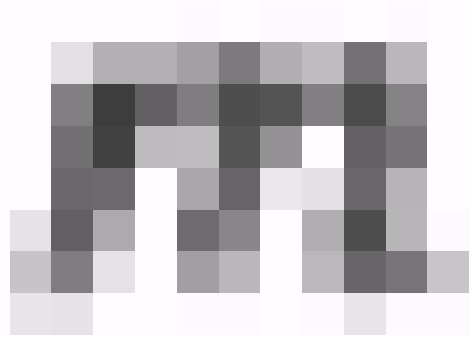
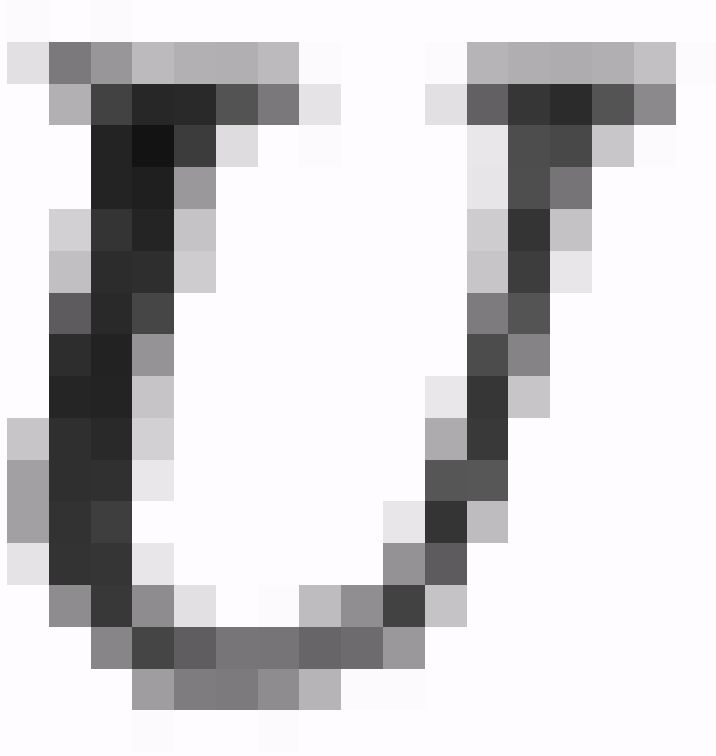



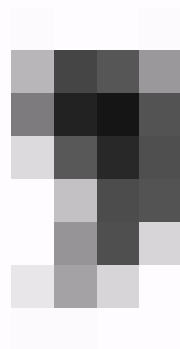
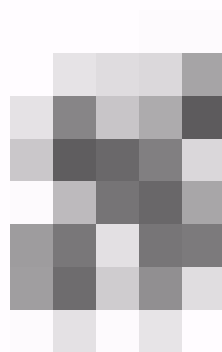
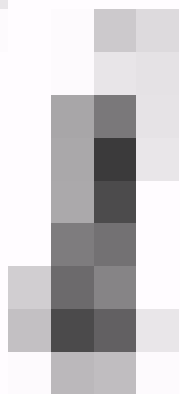
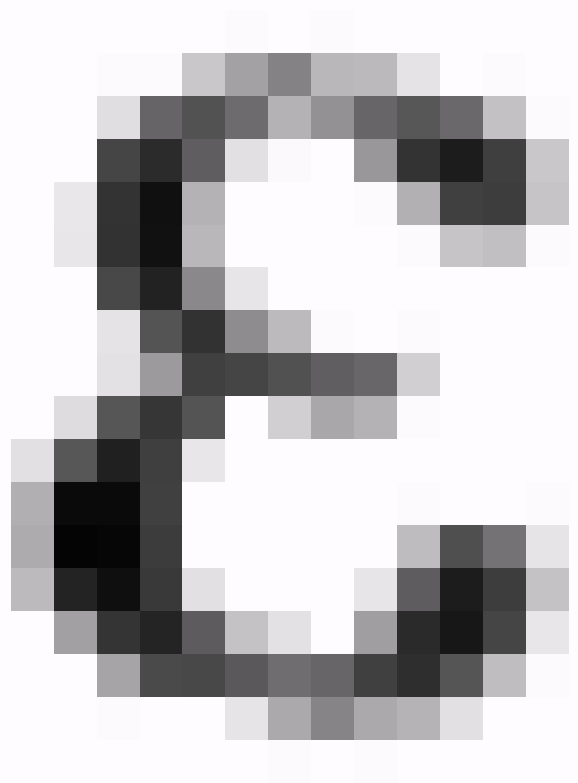

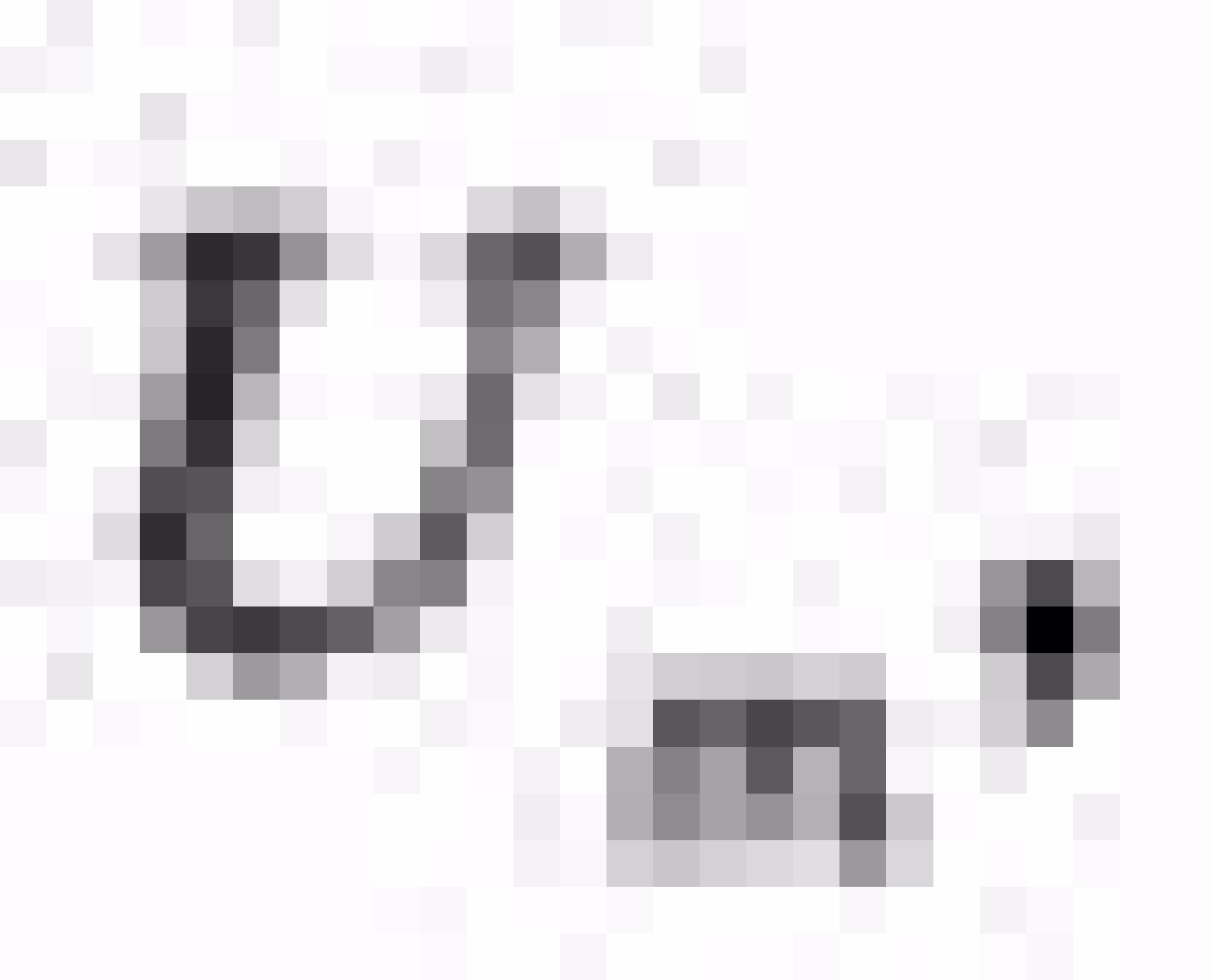

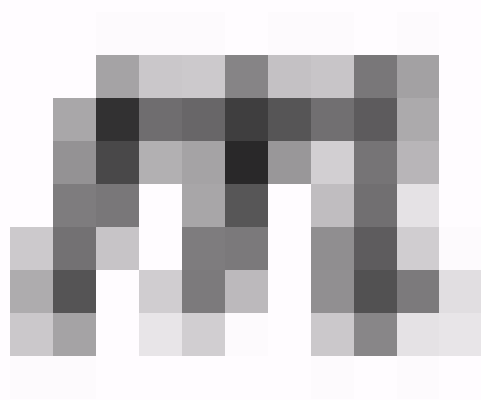
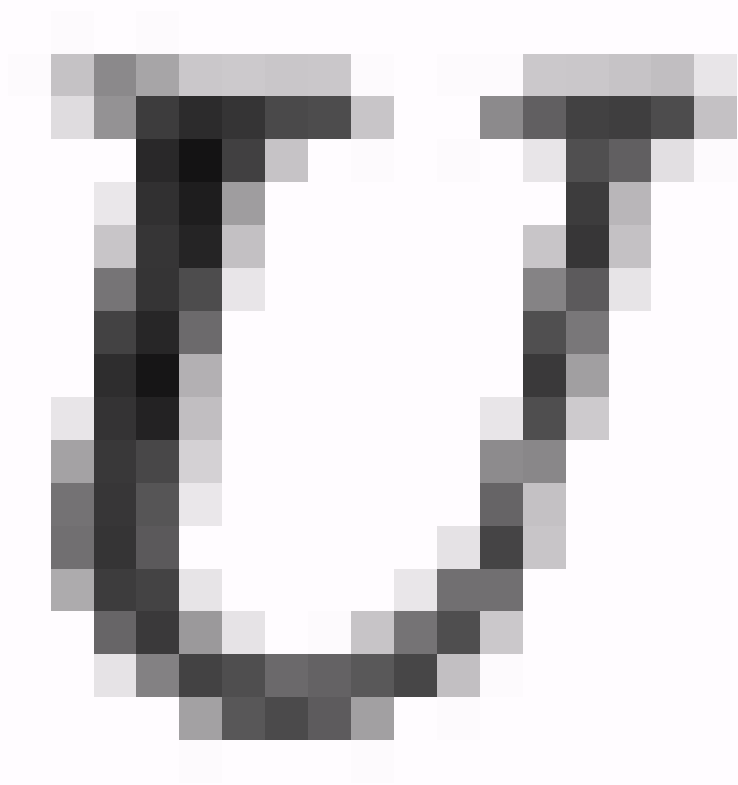

$$u = -I I_m \omega \sin \omega t = I I_m \omega \cos \left(\omega t + \frac{\pi}{2} \right) \quad (50.8)$$



Q = WC = V_m C₀₈ wt (50.2)

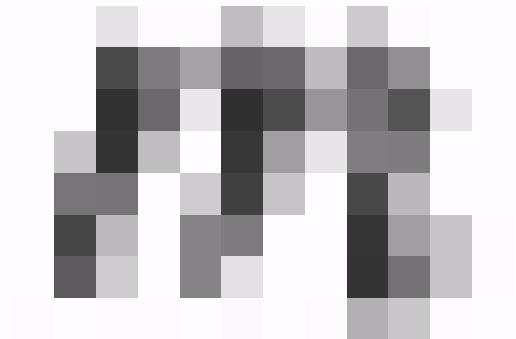
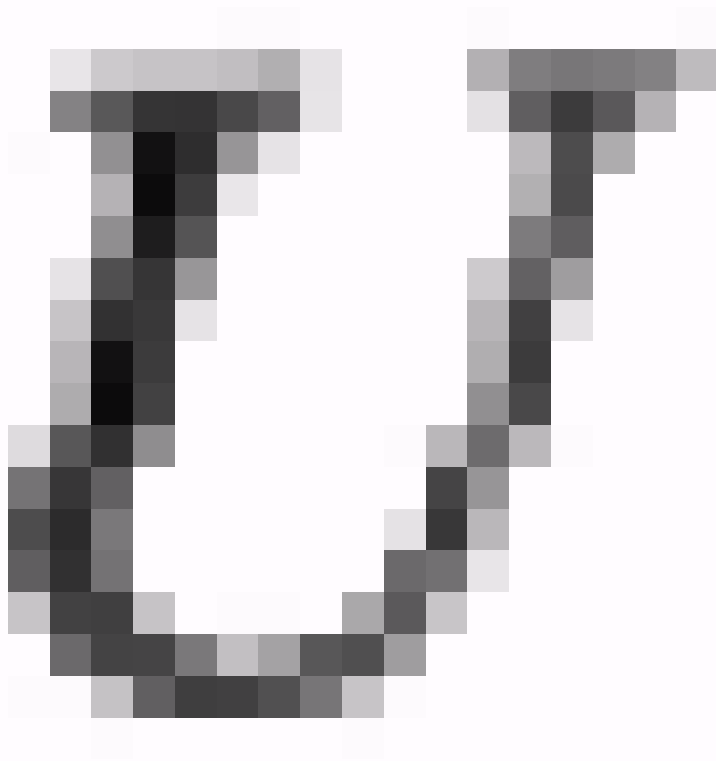

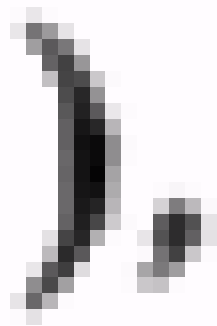
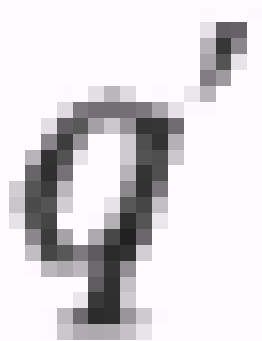

V_m

=

$I_{wo} M$

(50.9)

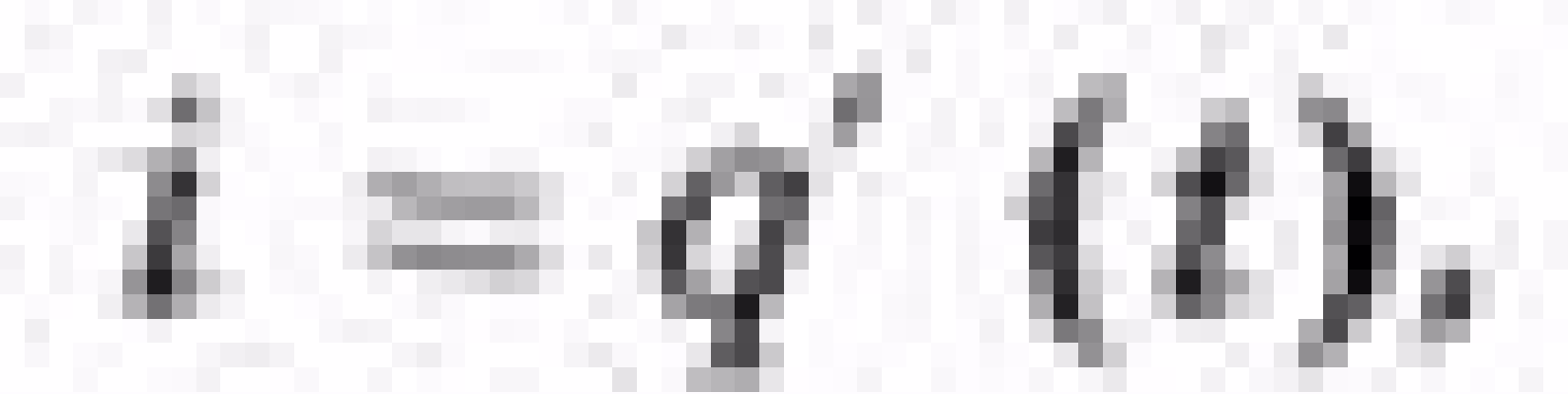

$$i = -V_m \omega C \sin \omega t = V_m \omega C \cos \left(\omega t + \frac{\pi}{2} \right) \quad (50.3).$$

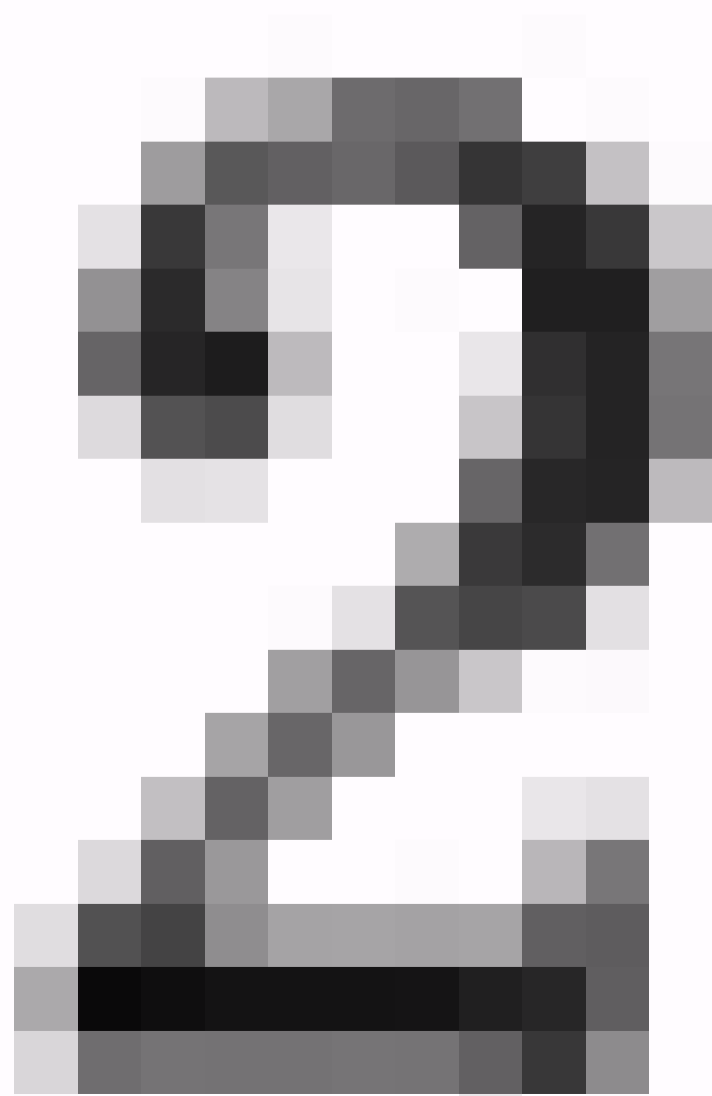
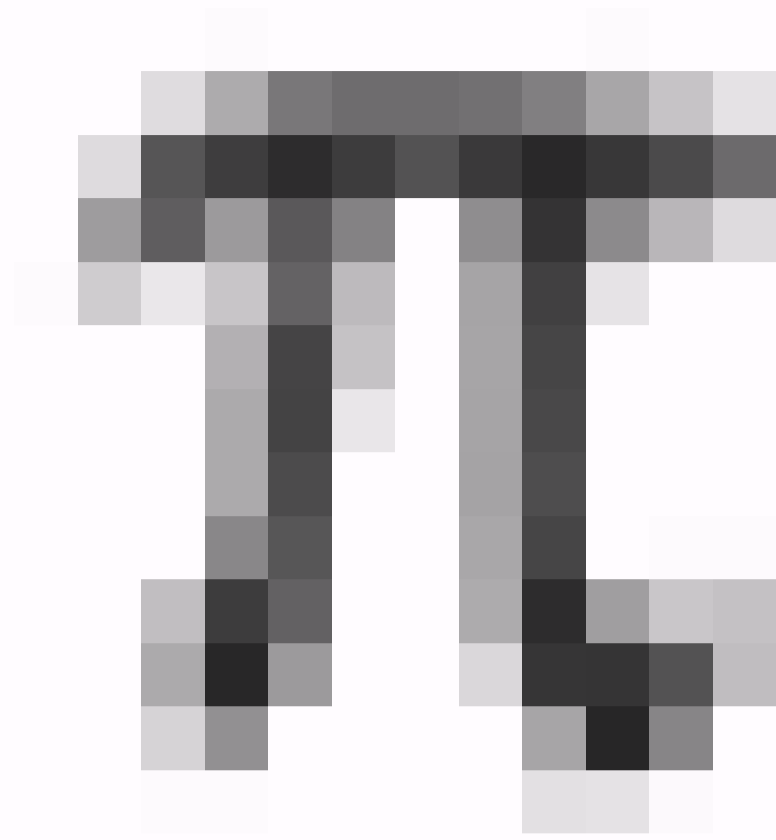

1. $\frac{1}{x} = x^{-1}$

2. $\frac{d}{dx} x^{-1} = -1 x^{-2}$

3. $= -\frac{1}{x^2}$

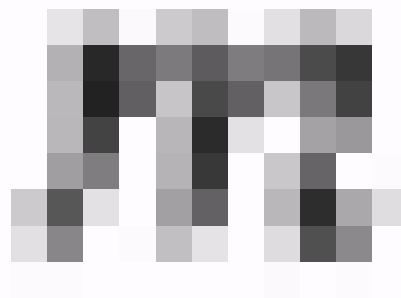
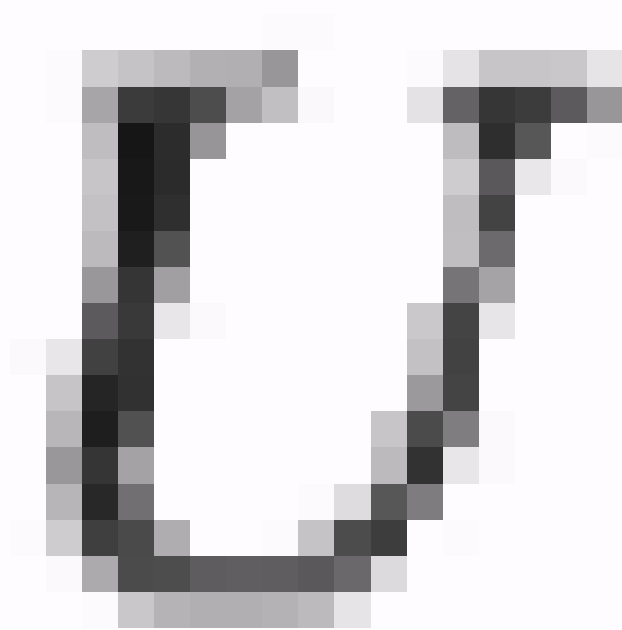

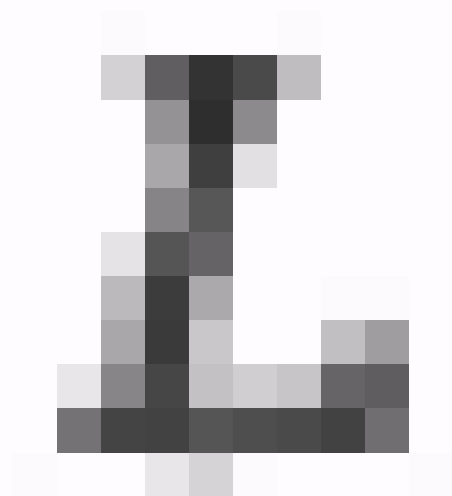
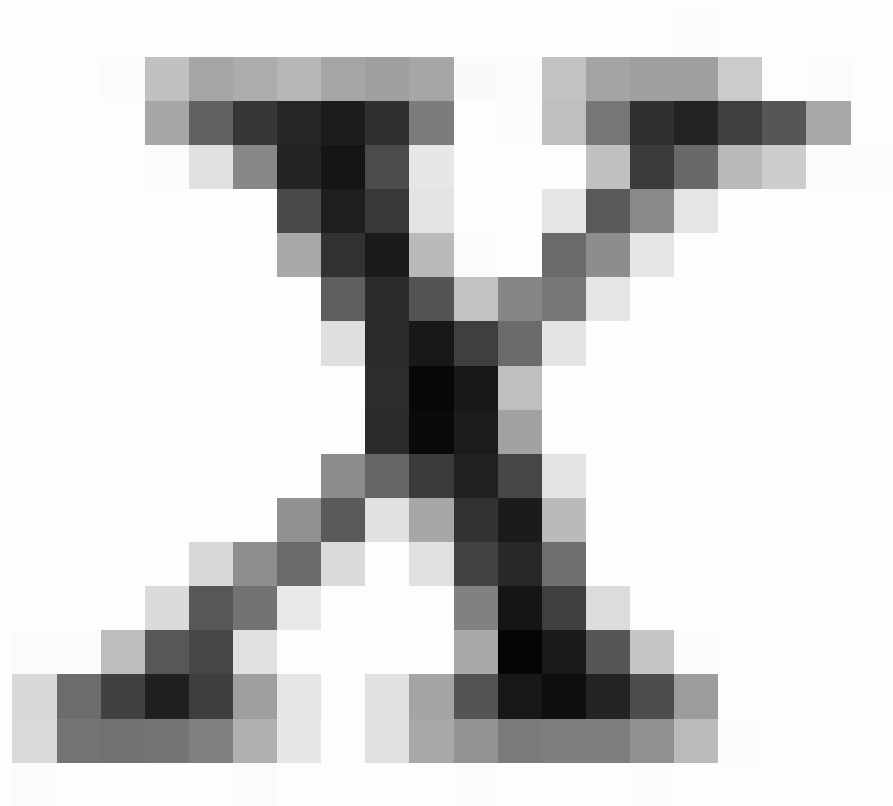

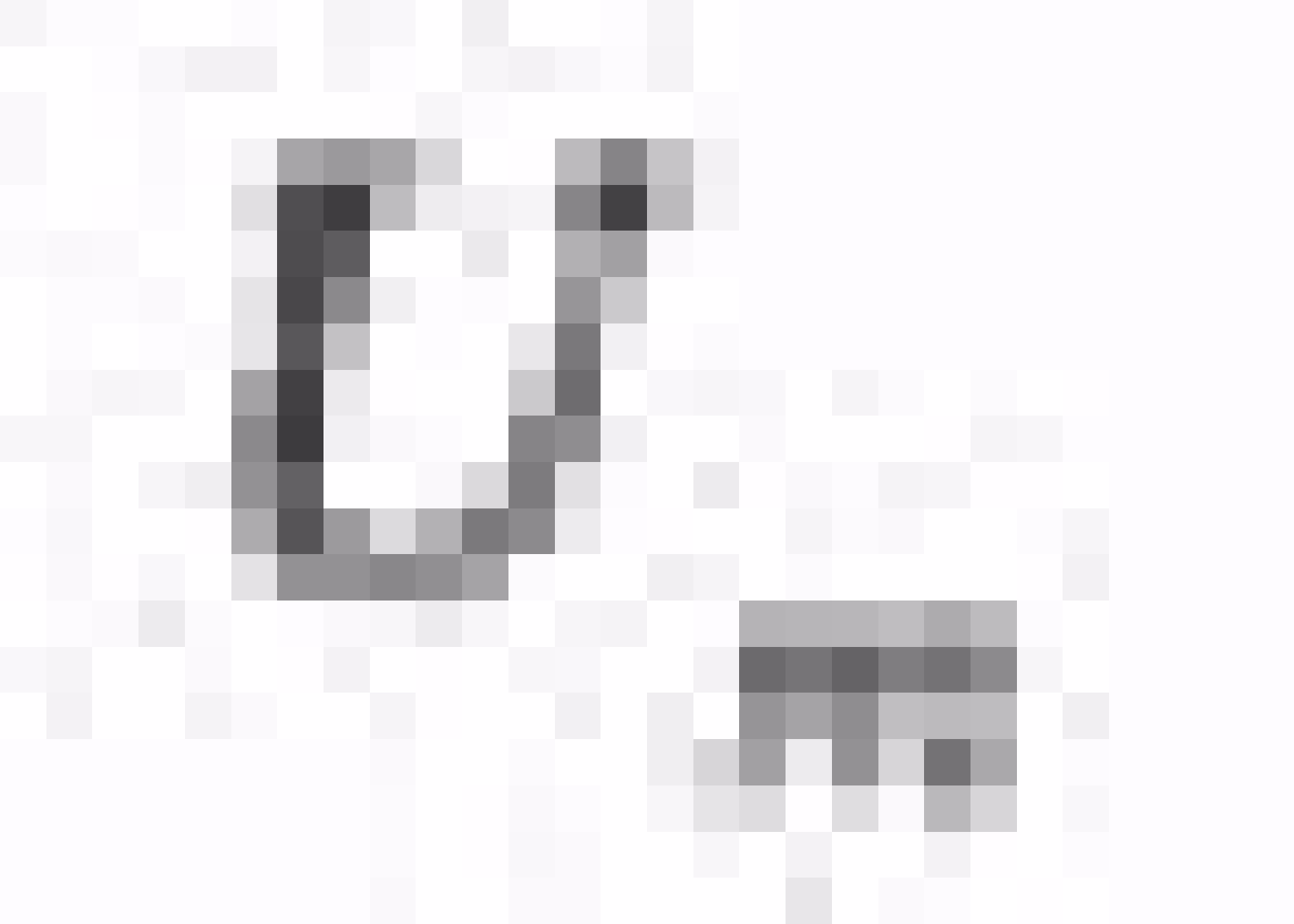

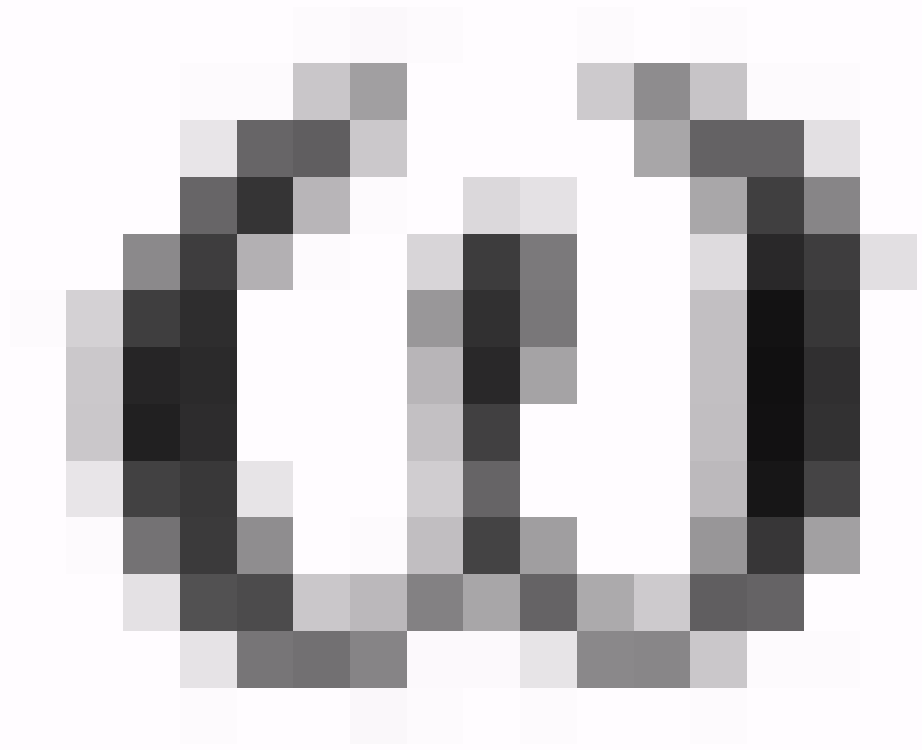

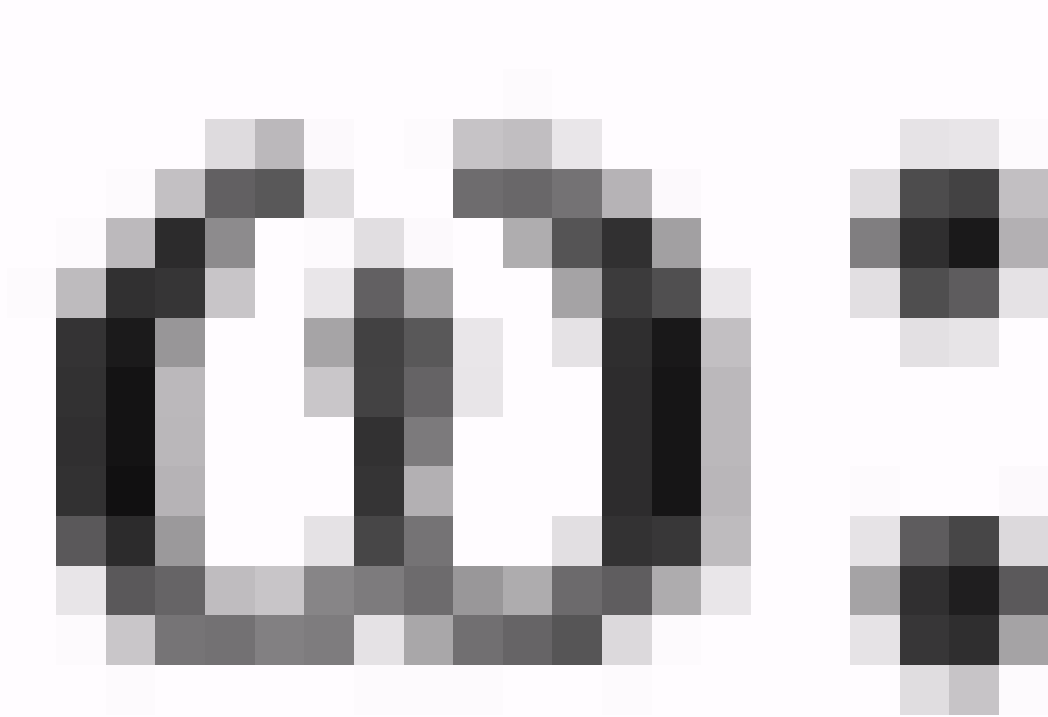

$X_1 = \omega_1$

(50, 10)

1

2

3

4

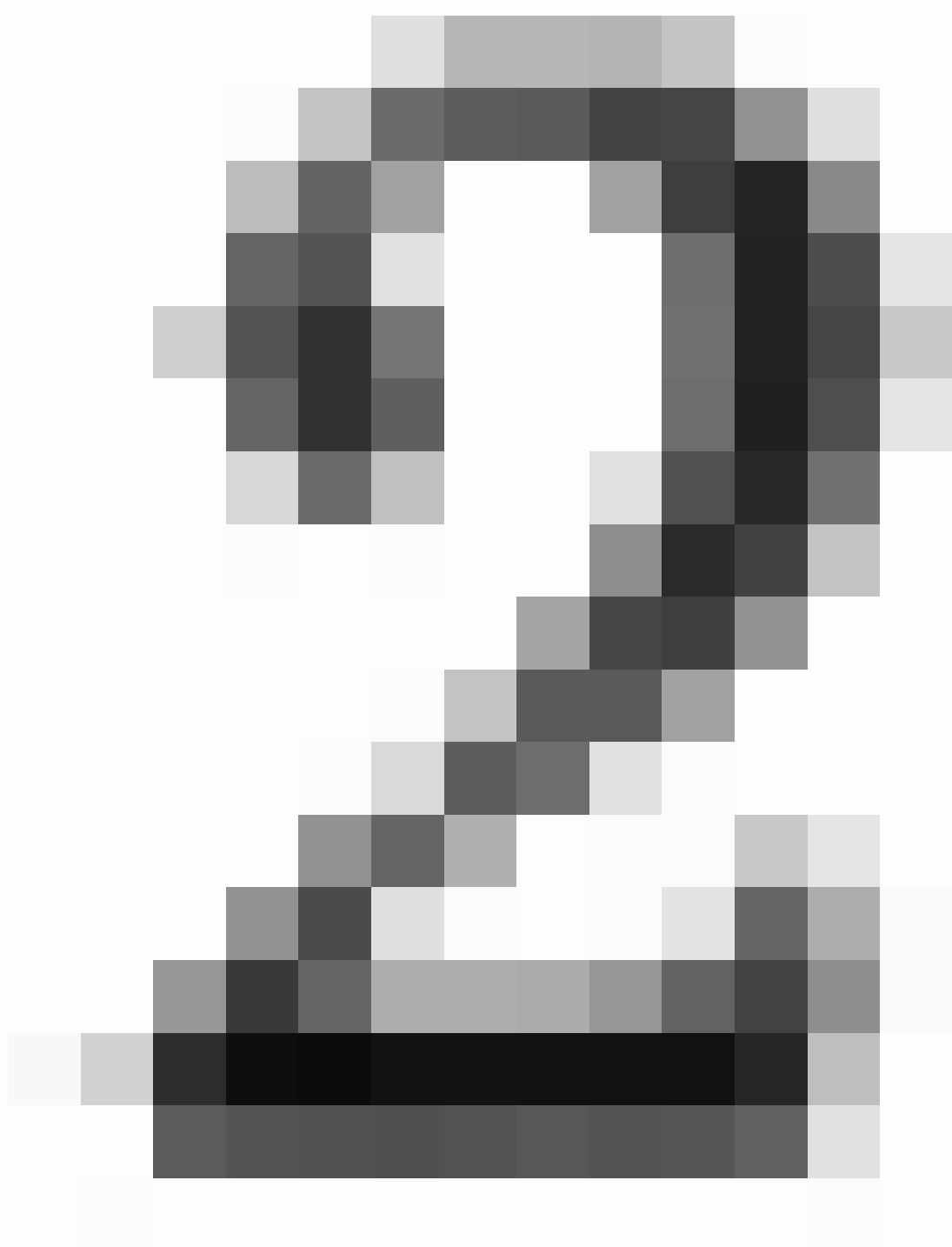
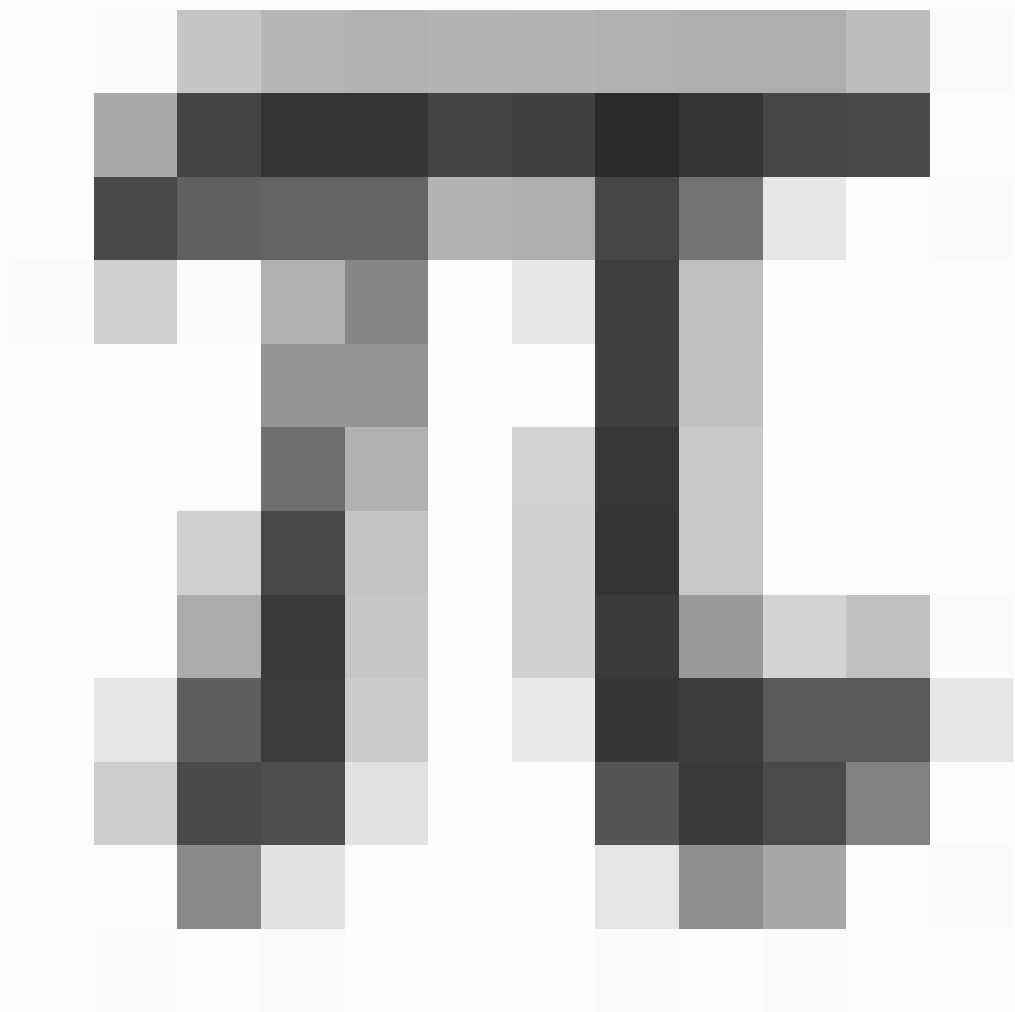

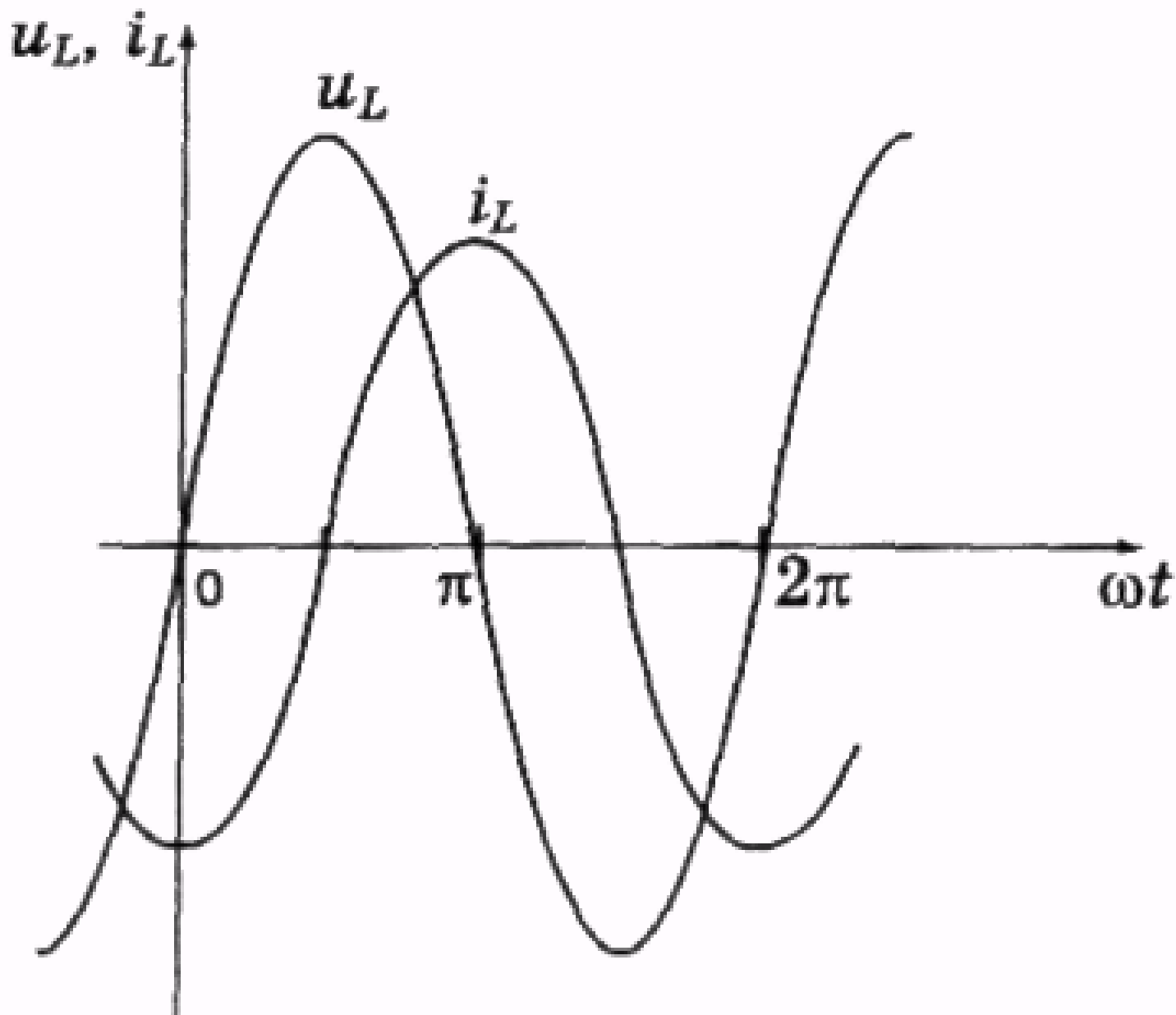

Мал. 2.162



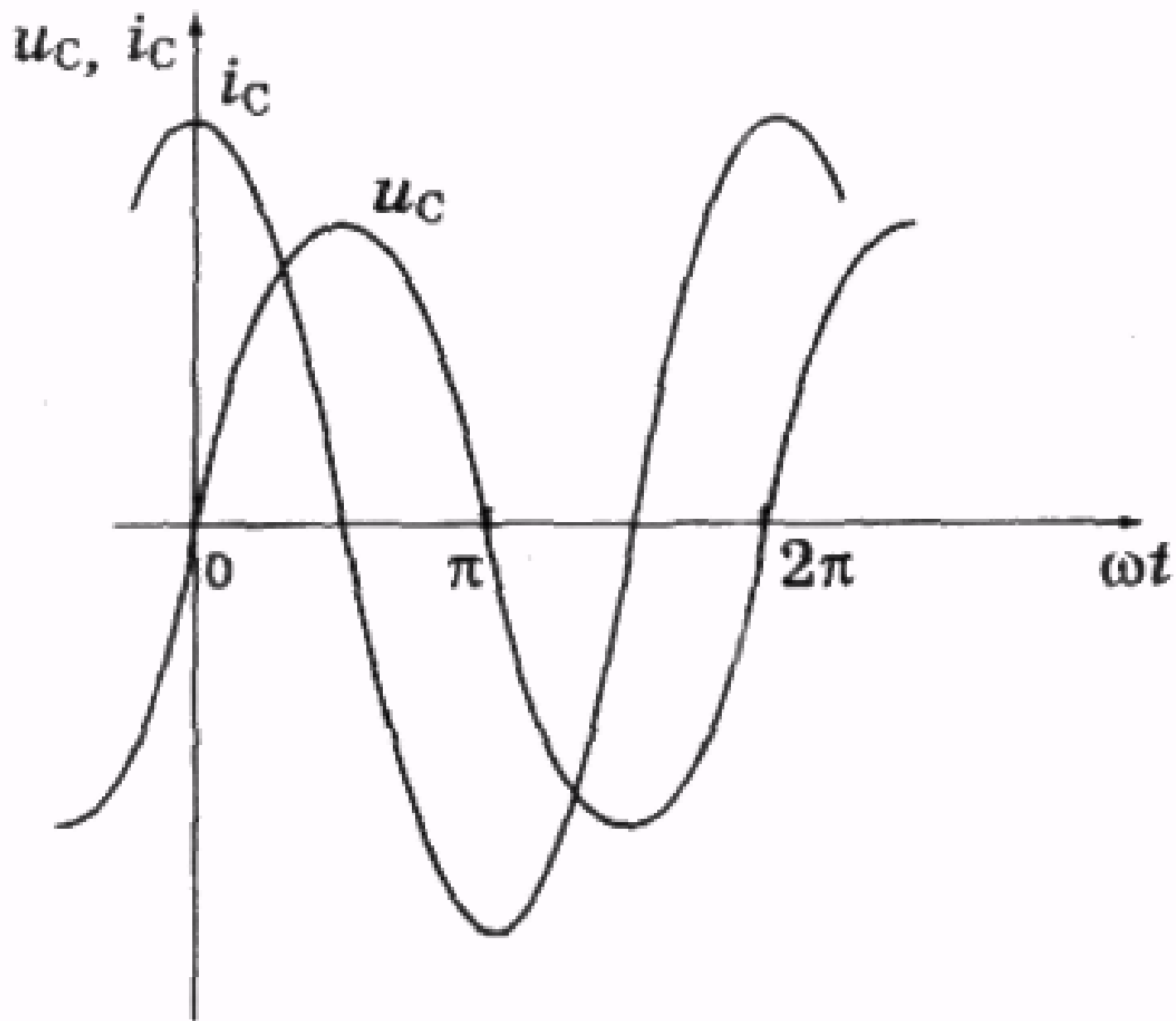

Мал. 2.161

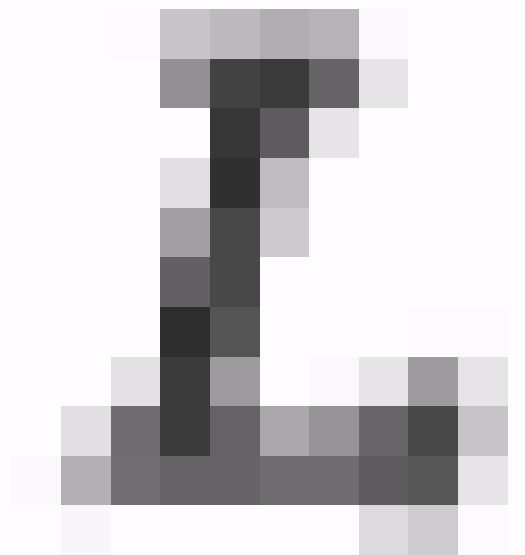
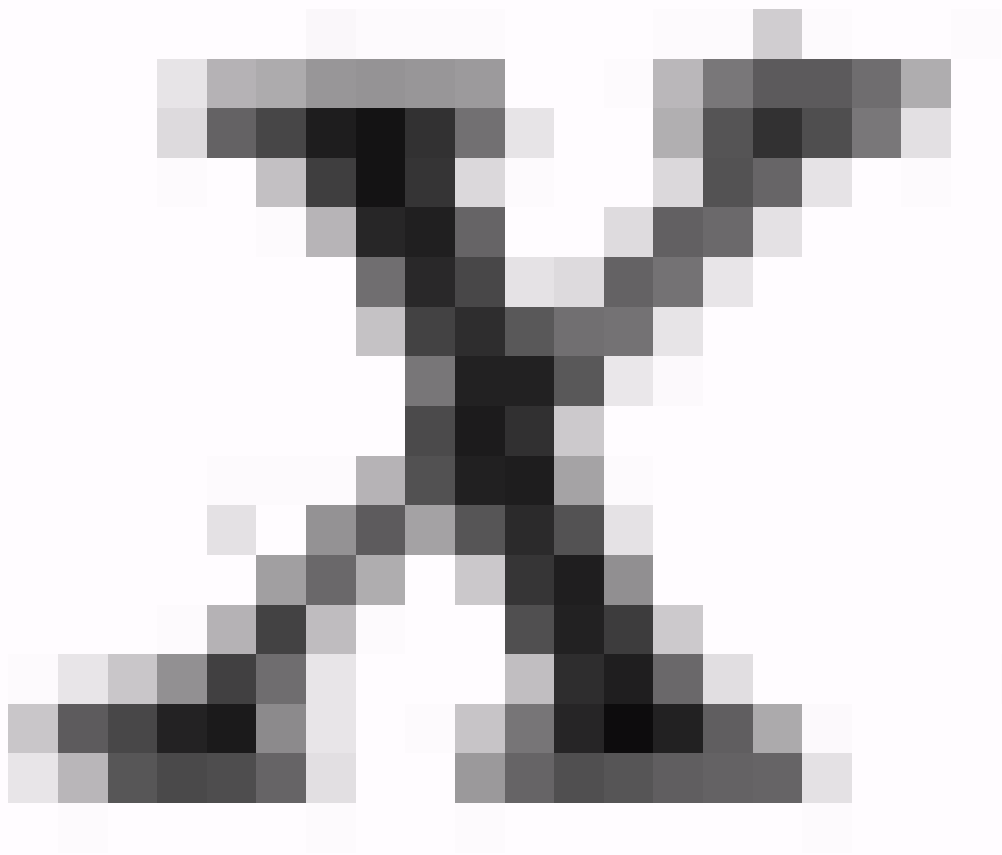

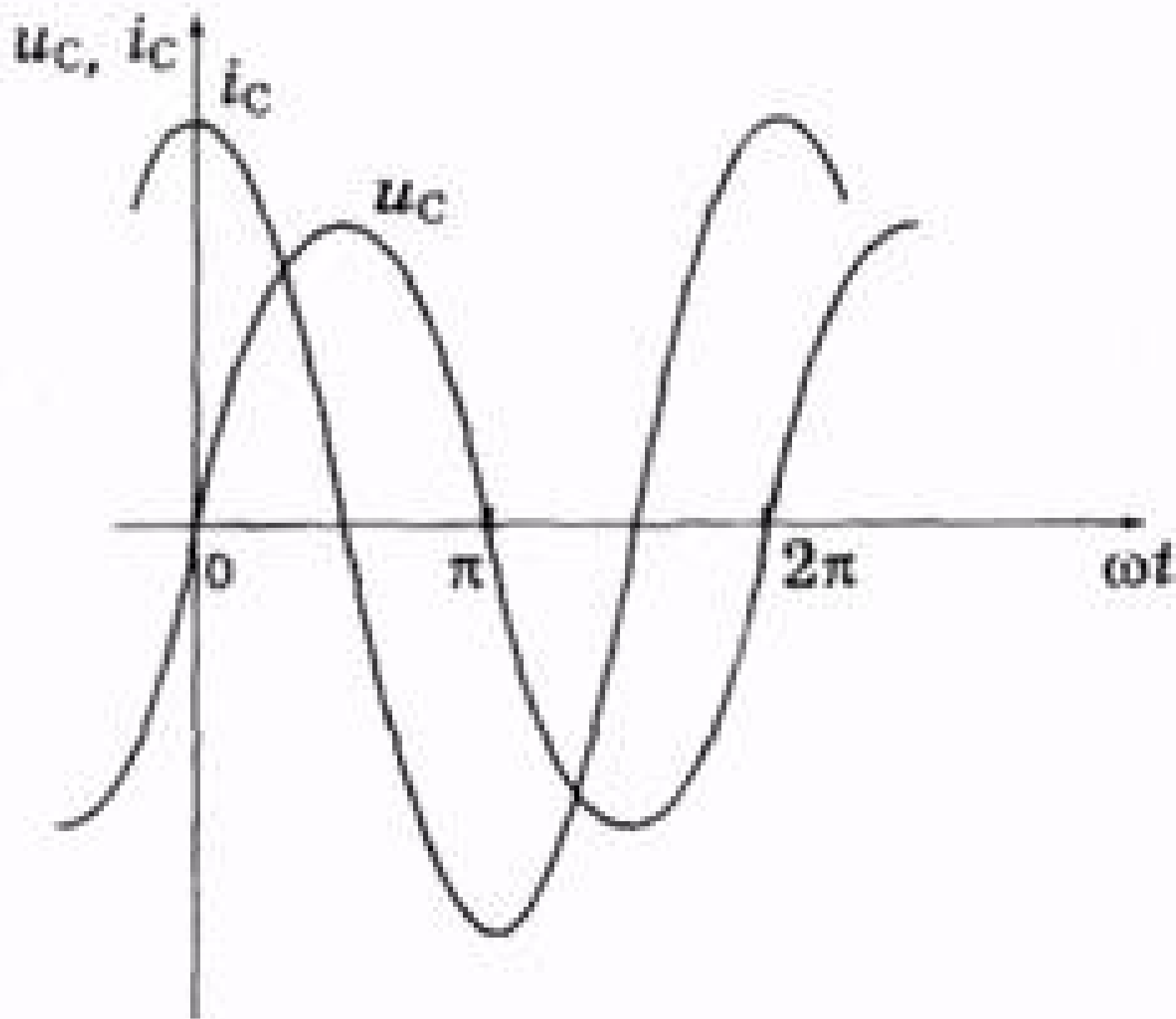

Мал. 2.161

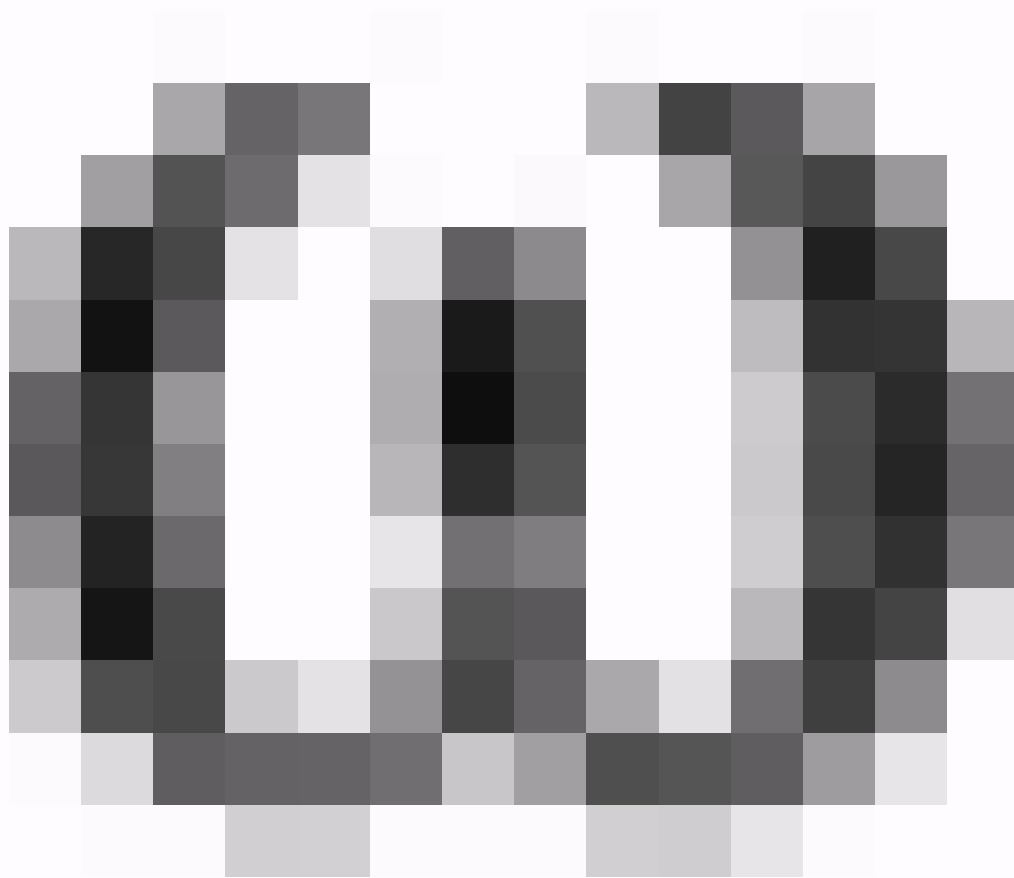

$$I_m = \frac{U_m}{X_L} \quad (50.11)$$



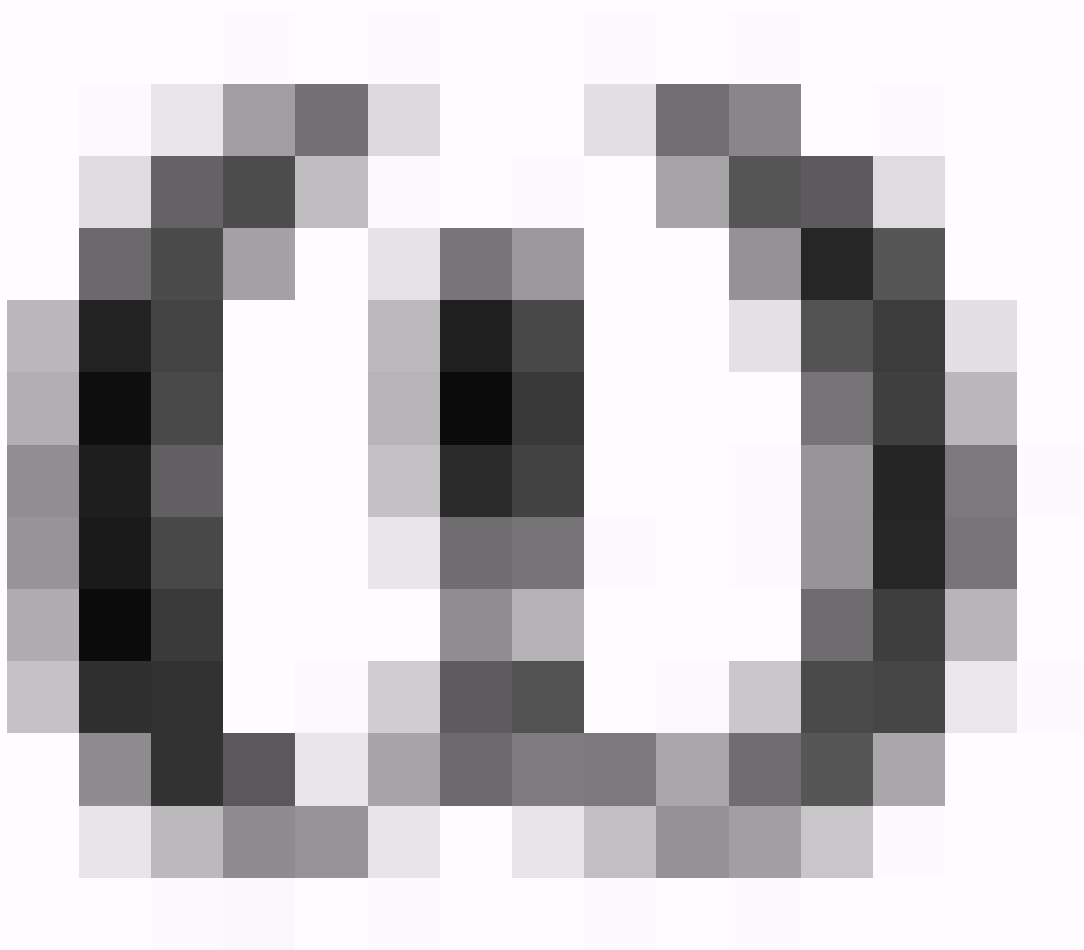

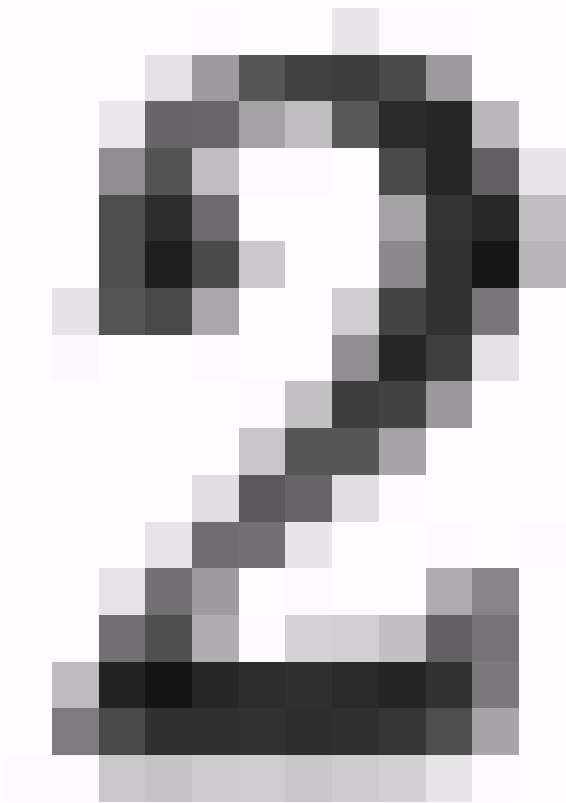
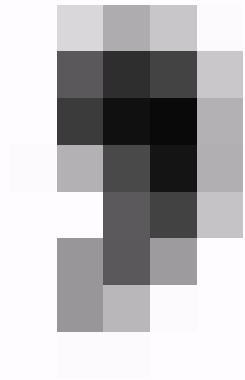
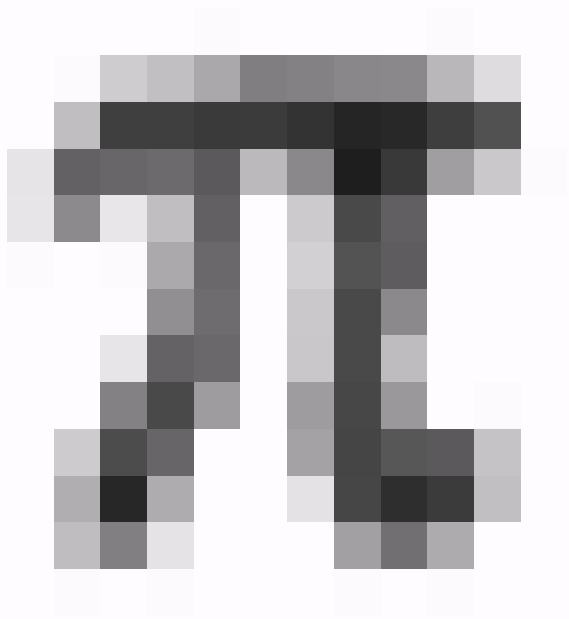

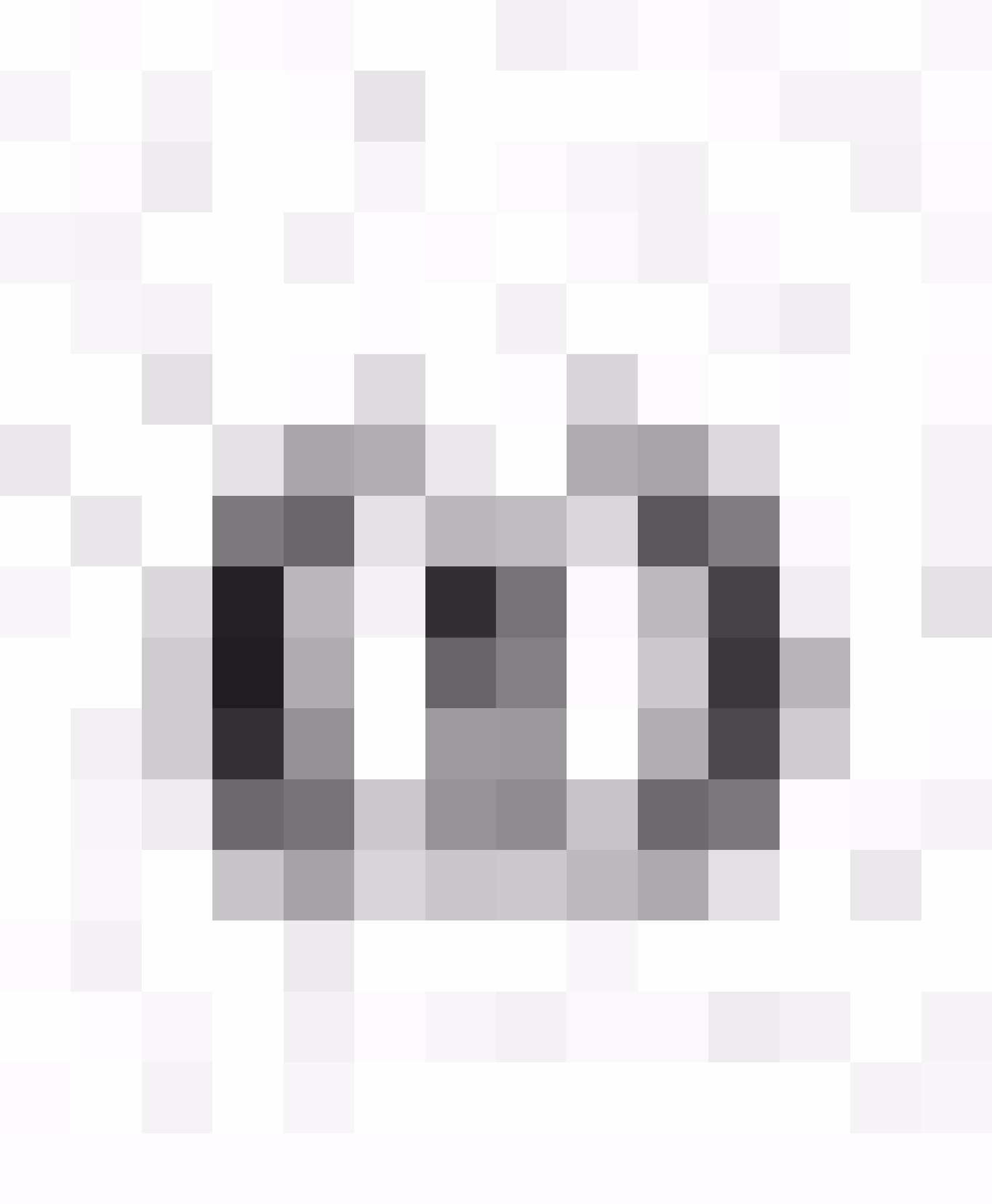

$$X_c = \frac{1}{\omega C} \quad (50.5)$$

$$i = I_m \cos \omega t, \quad u = U_m \cos \omega t$$

$$R = \frac{U_m}{I_m} \quad (50.12).$$



$$I_m = \frac{U_m}{X_c} \quad (50.6)$$

$$P = iW = I_m V_m \cos^2 \omega t \quad (50.13)$$

100

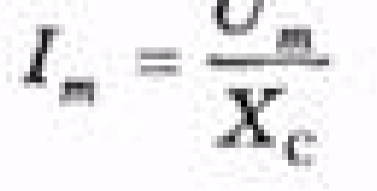

100

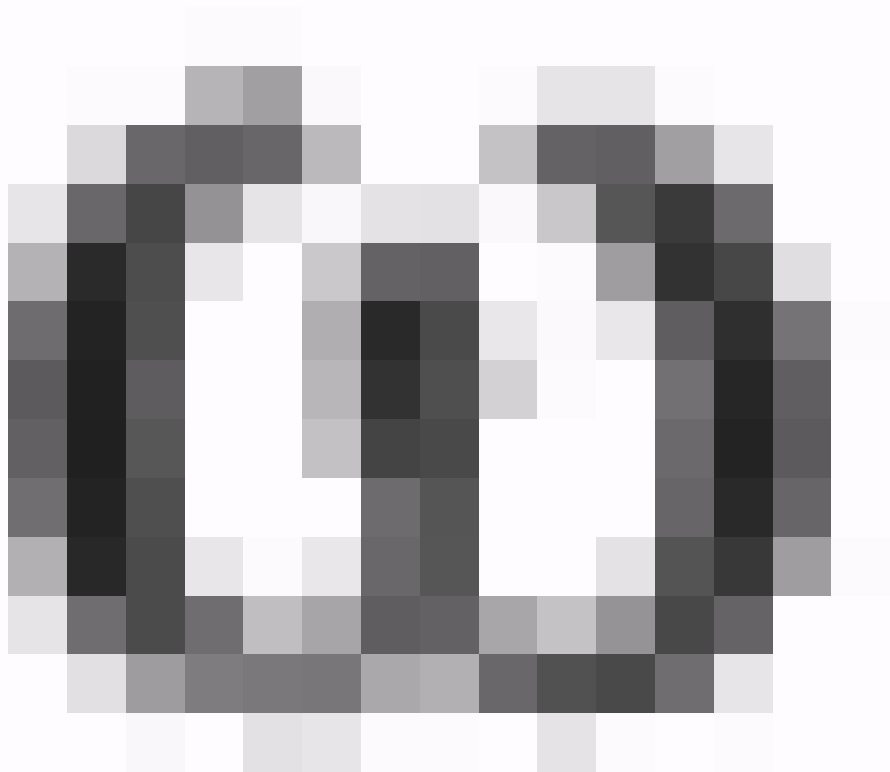

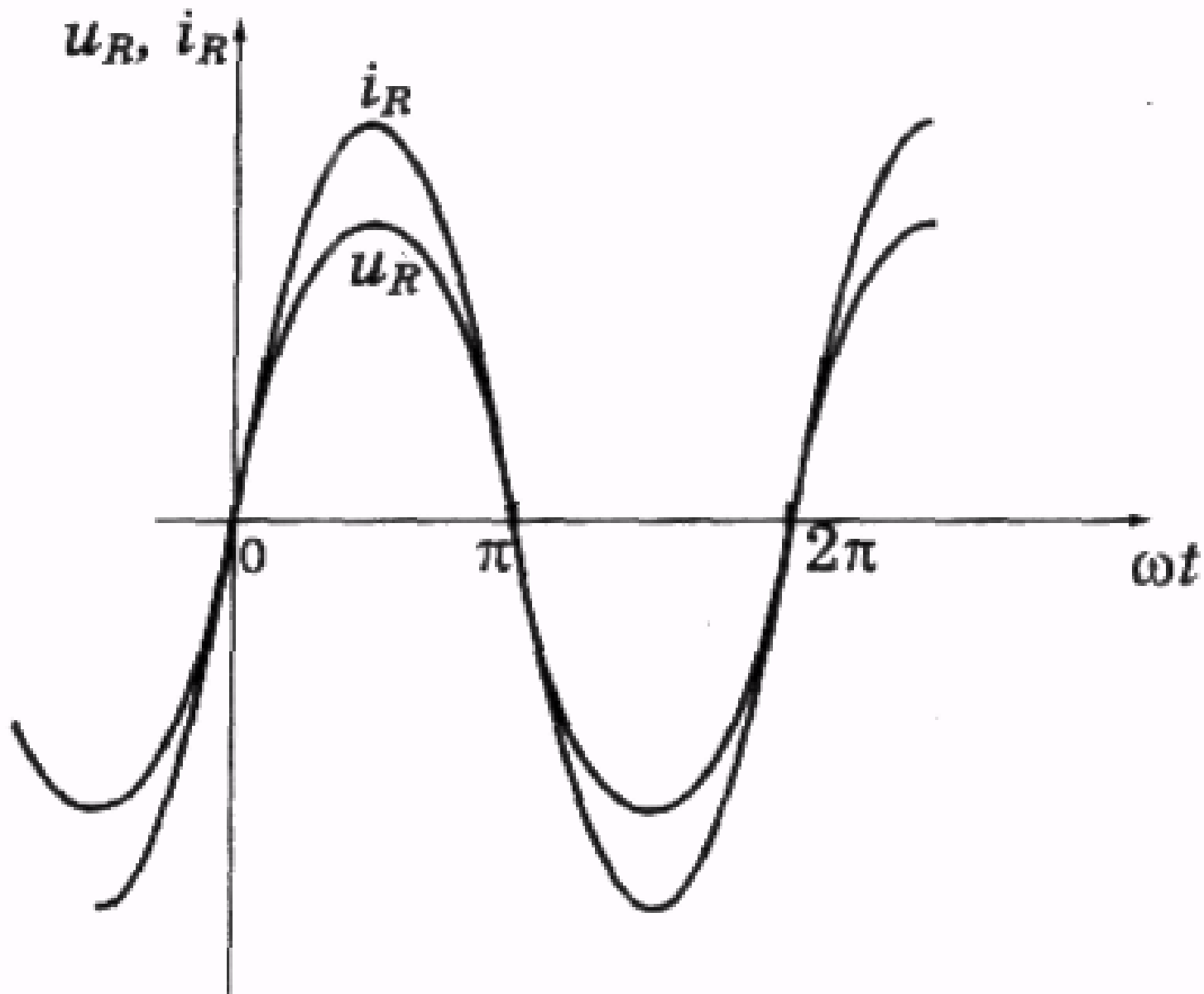

Мал. 2.163



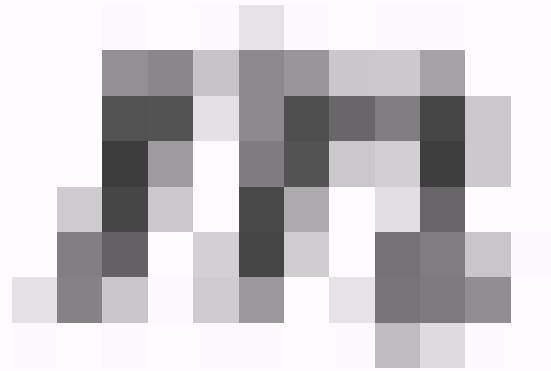
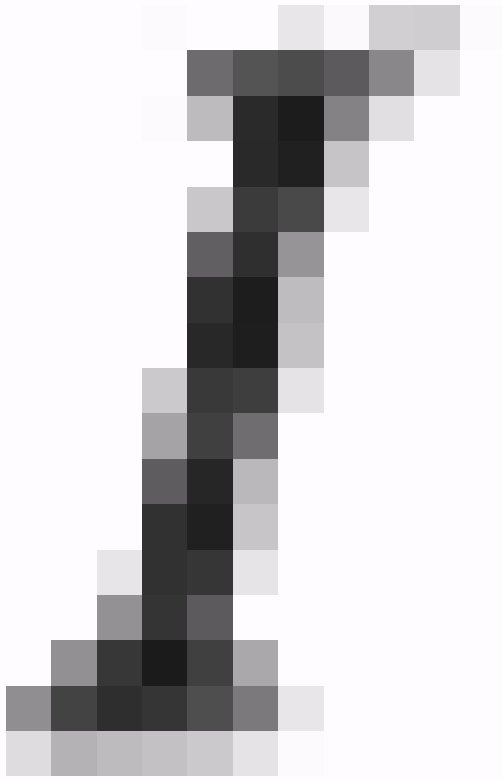

0000

000



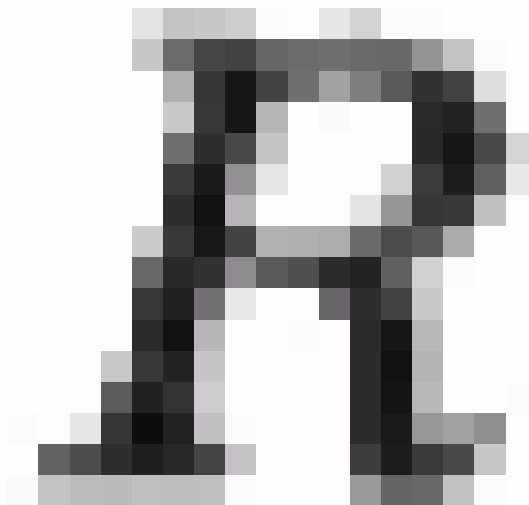
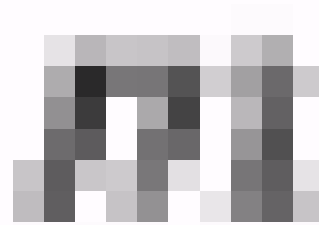
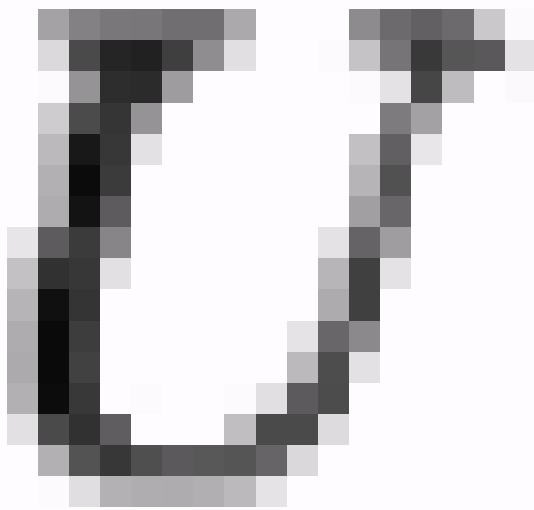

$$\bar{P} = \frac{IUV}{2}$$

(50.14).

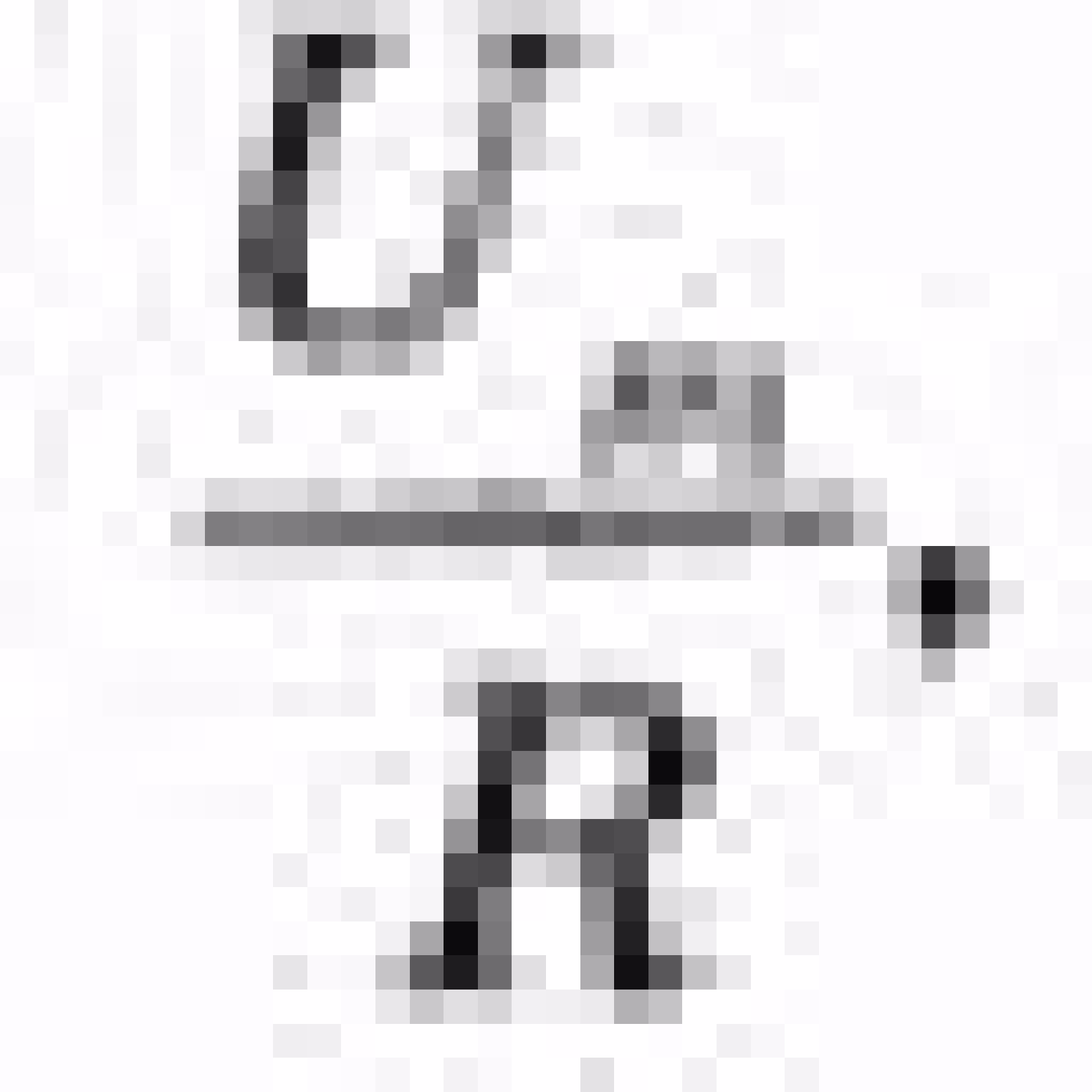

I

A

<

U

A

.

R

$$I = \frac{I_m}{\sqrt{2}}, \quad U = \frac{U_m}{\sqrt{2}} \quad (50.15 \text{ i } 50.16)$$

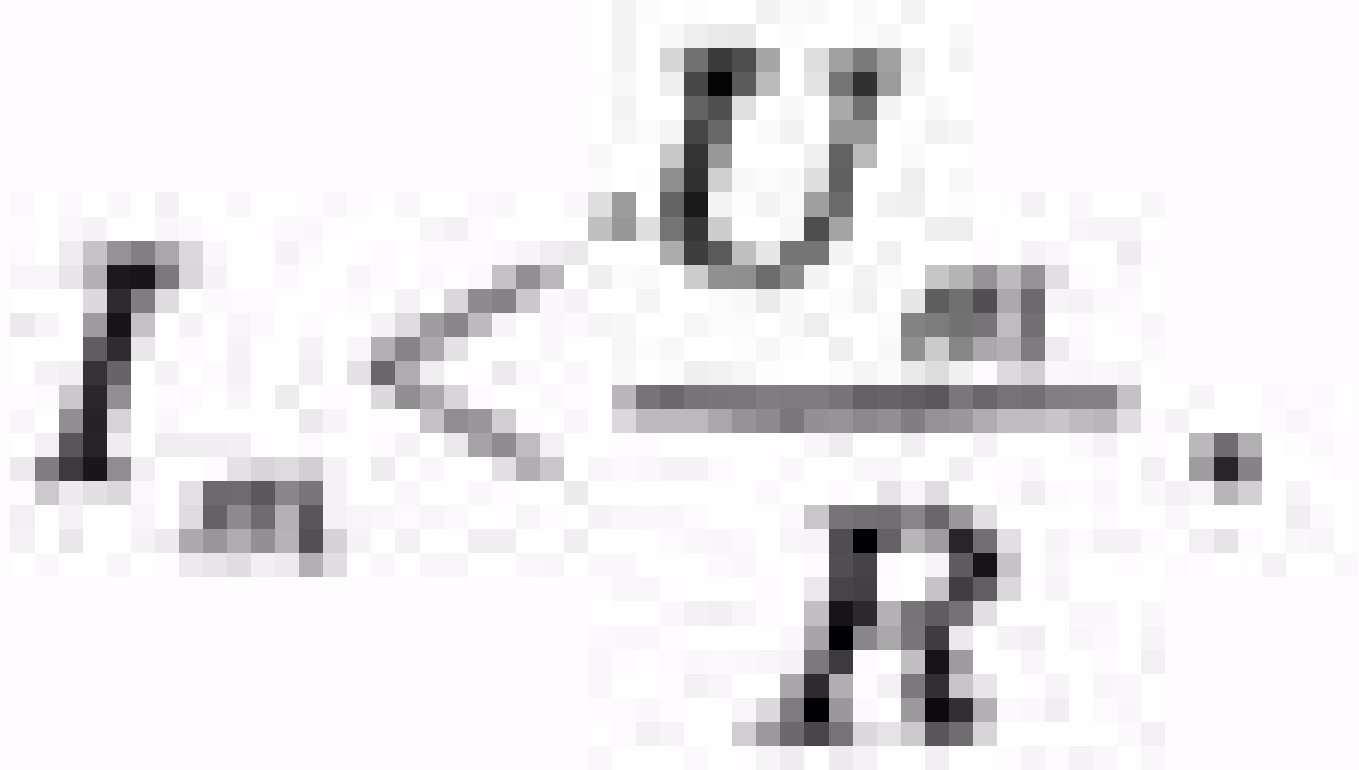

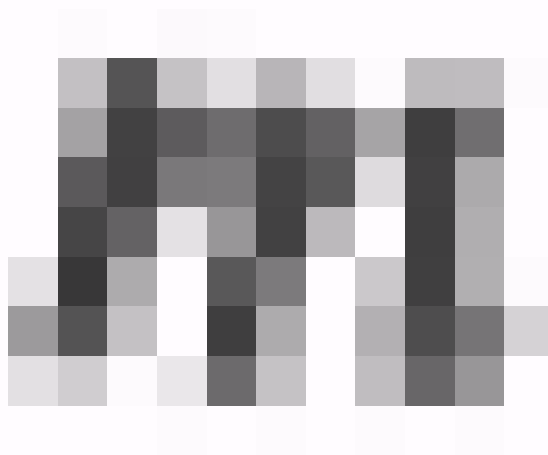
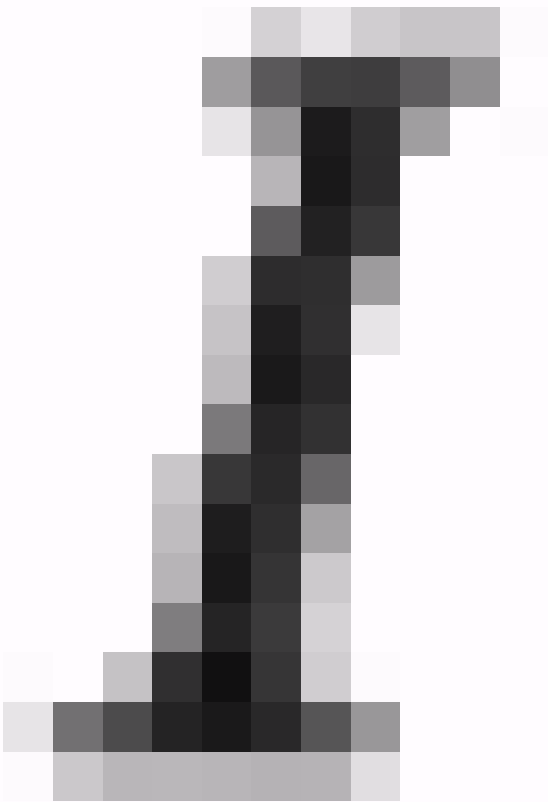

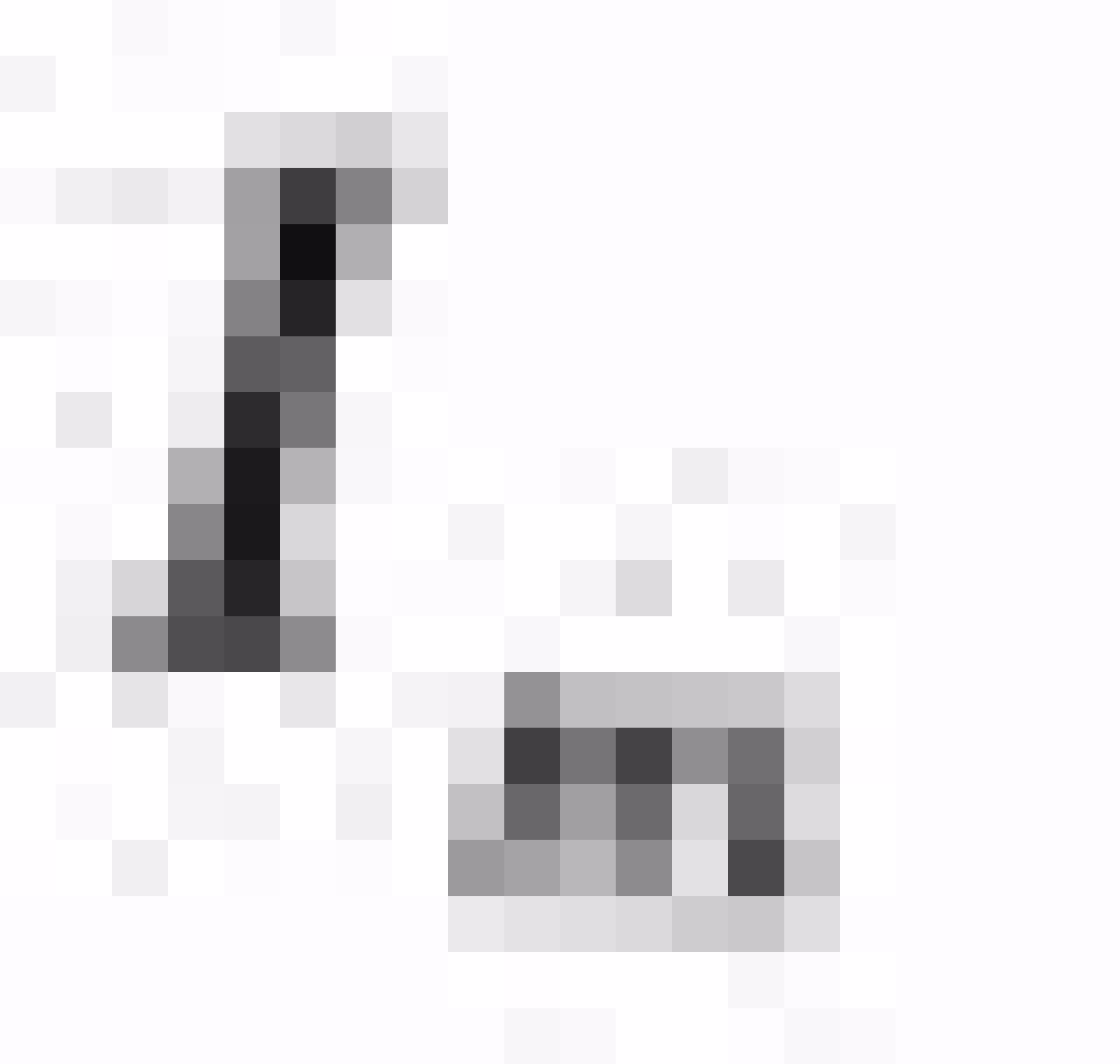

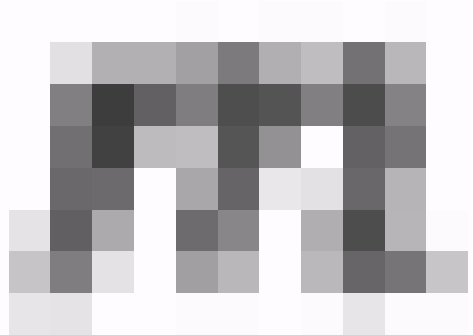
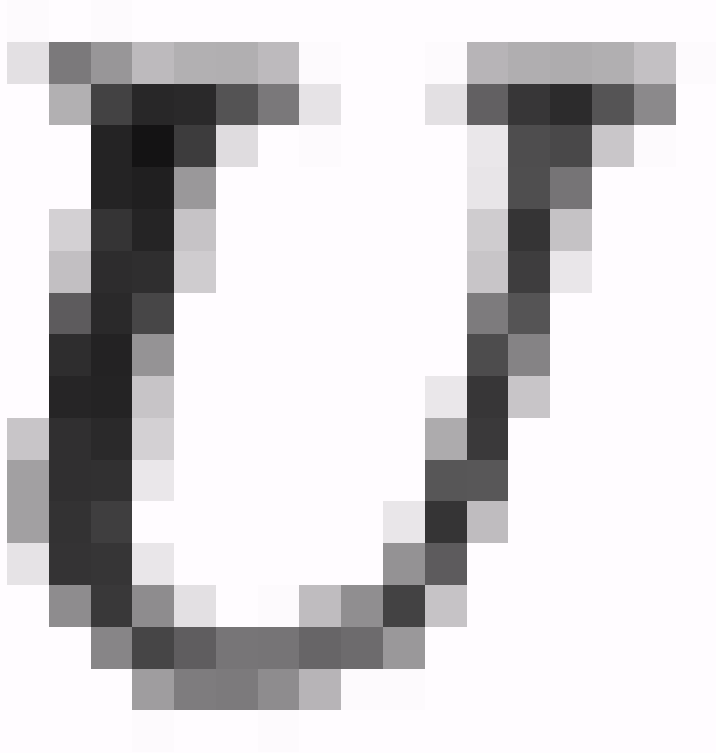

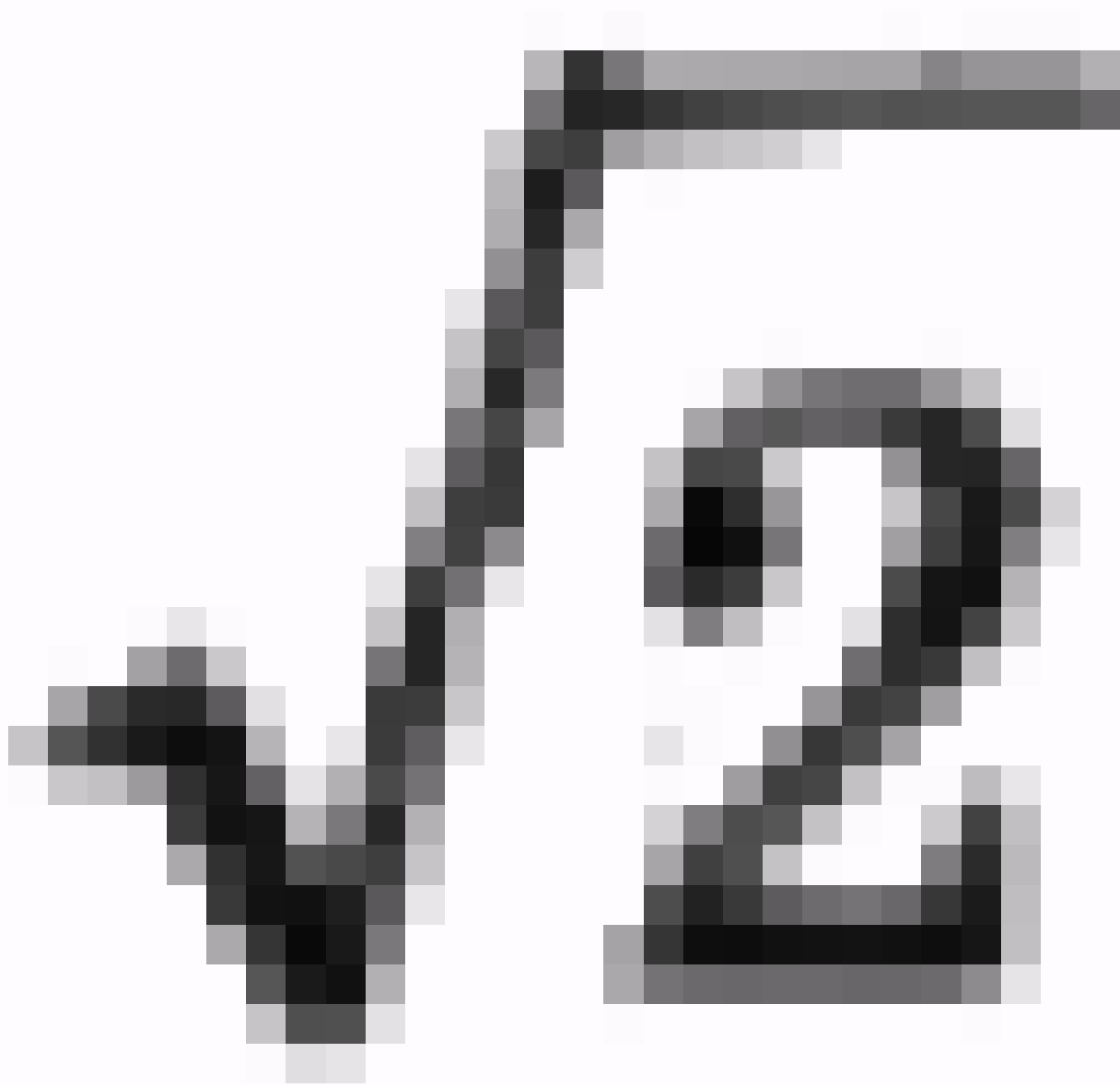

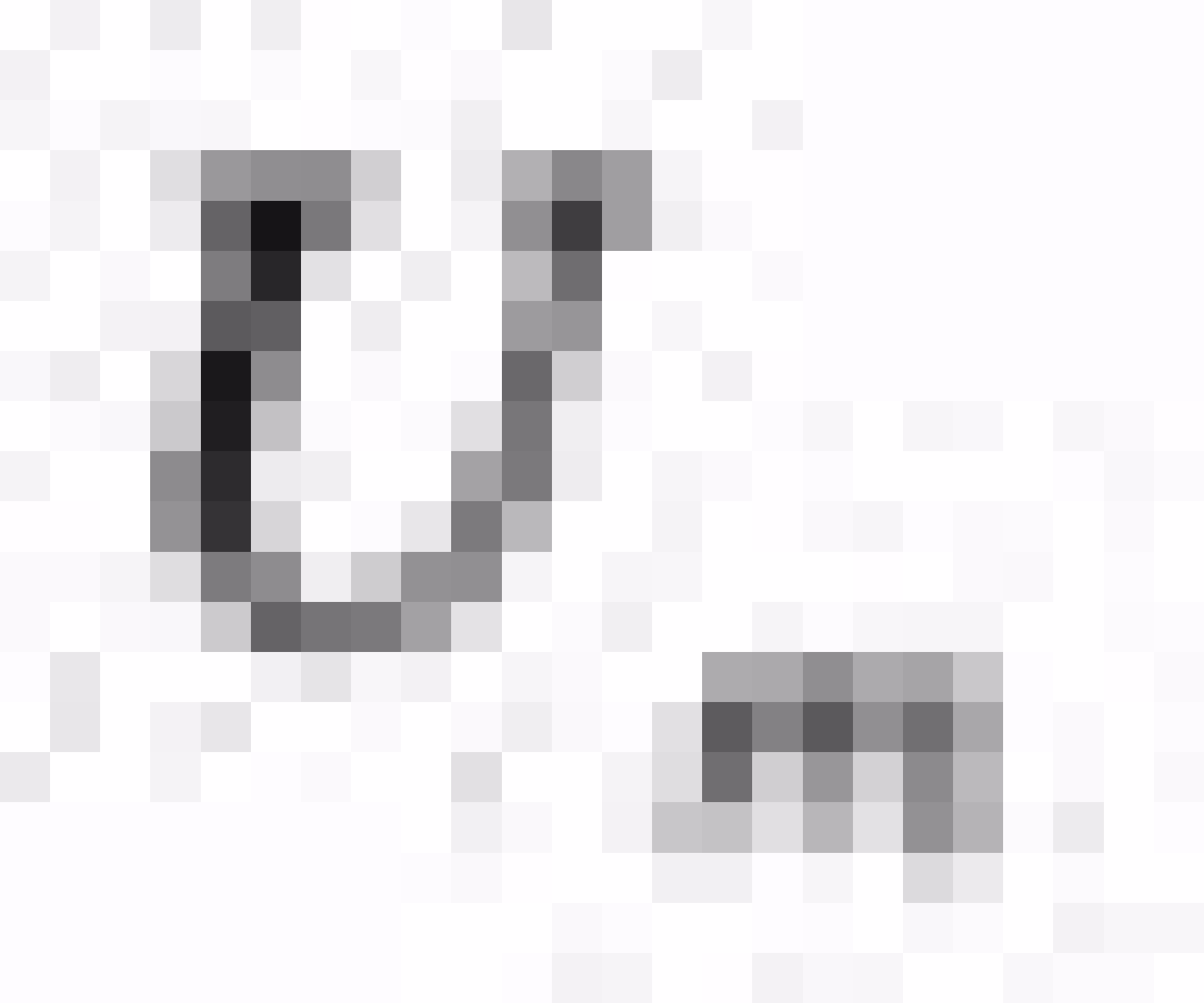

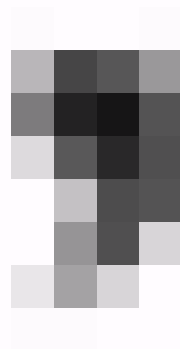
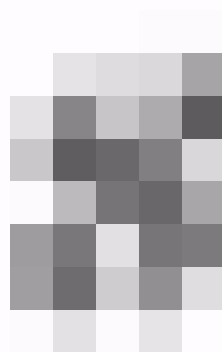
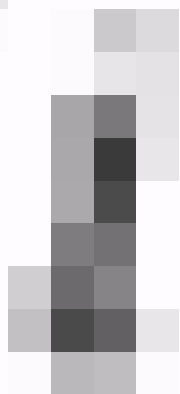
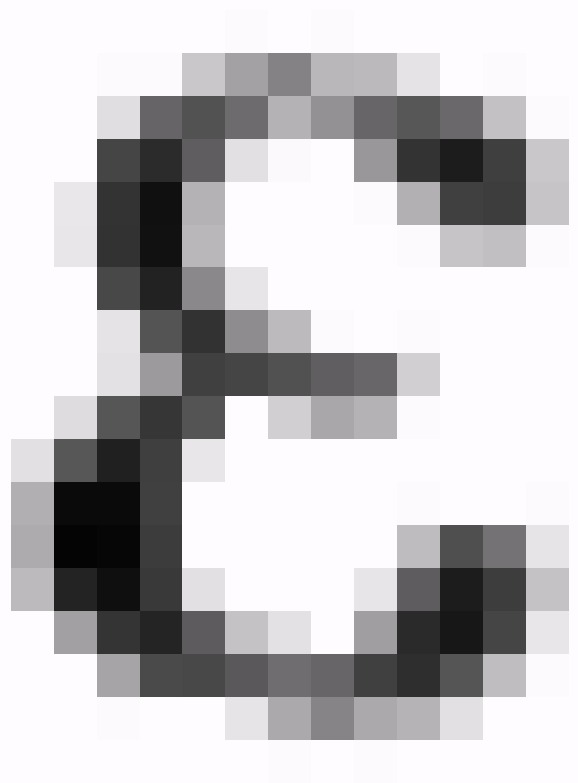

$$U_m = U \sqrt{2}, \quad U_m = 220\text{B} \cdot \sqrt{2} \approx 311\text{B}.$$

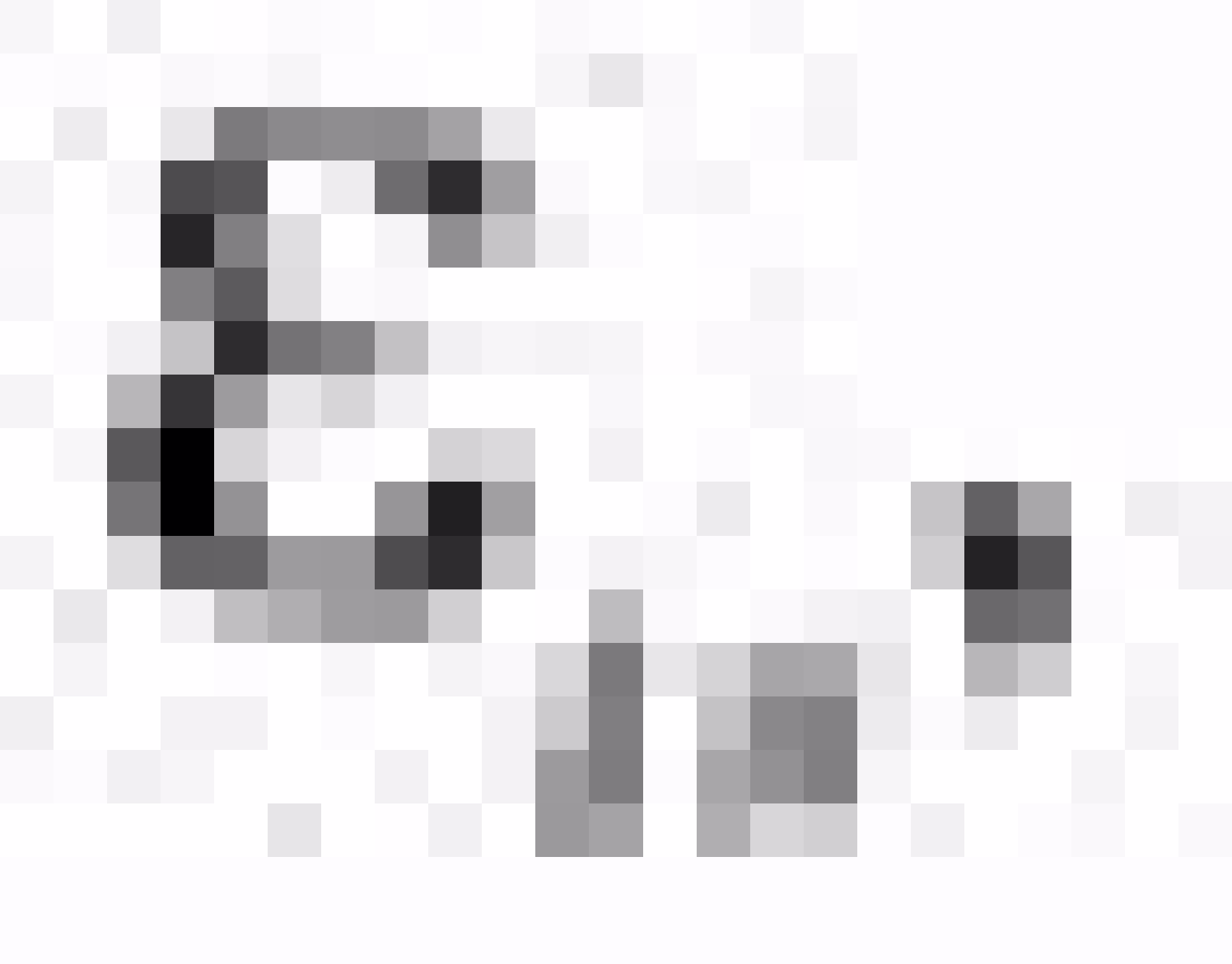

W = $\frac{1}{2} \rho v^2$

W = $\frac{1}{2} \rho v^2$

(50) (7)

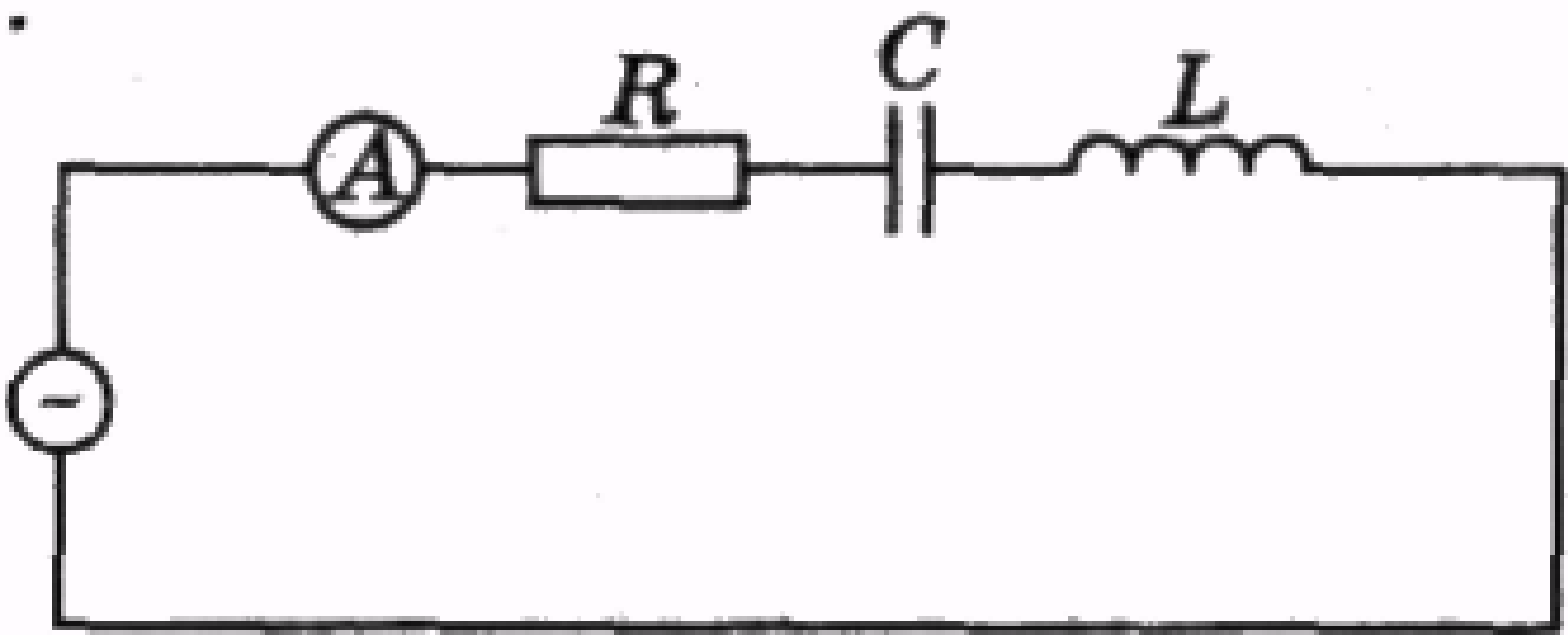

Мал. 2.164

W

W

W

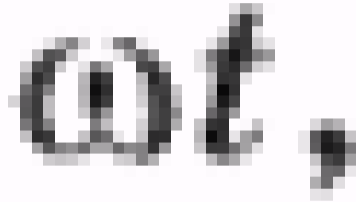
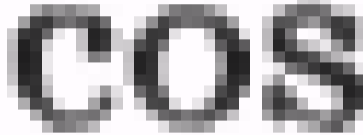
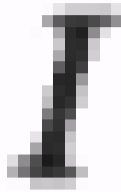

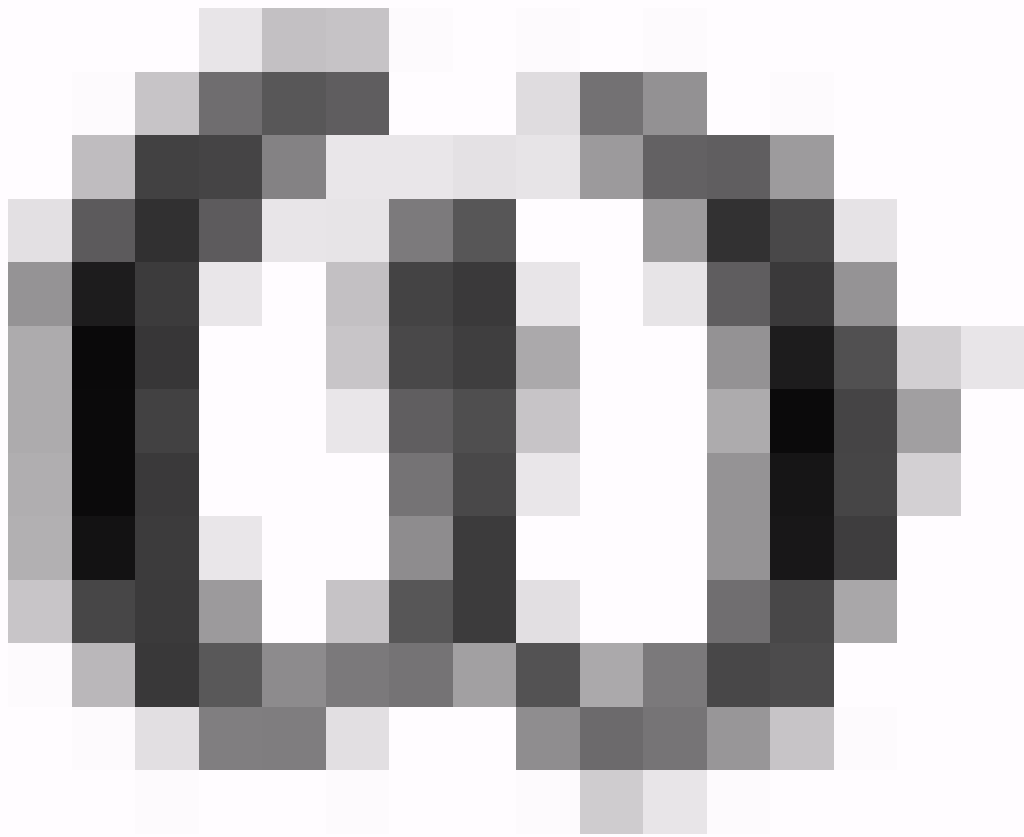



$$u = -I I_m \omega \sin \omega t = I I_m \omega \cos \left(\omega t + \frac{\pi}{2} \right) \quad (50.8)$$

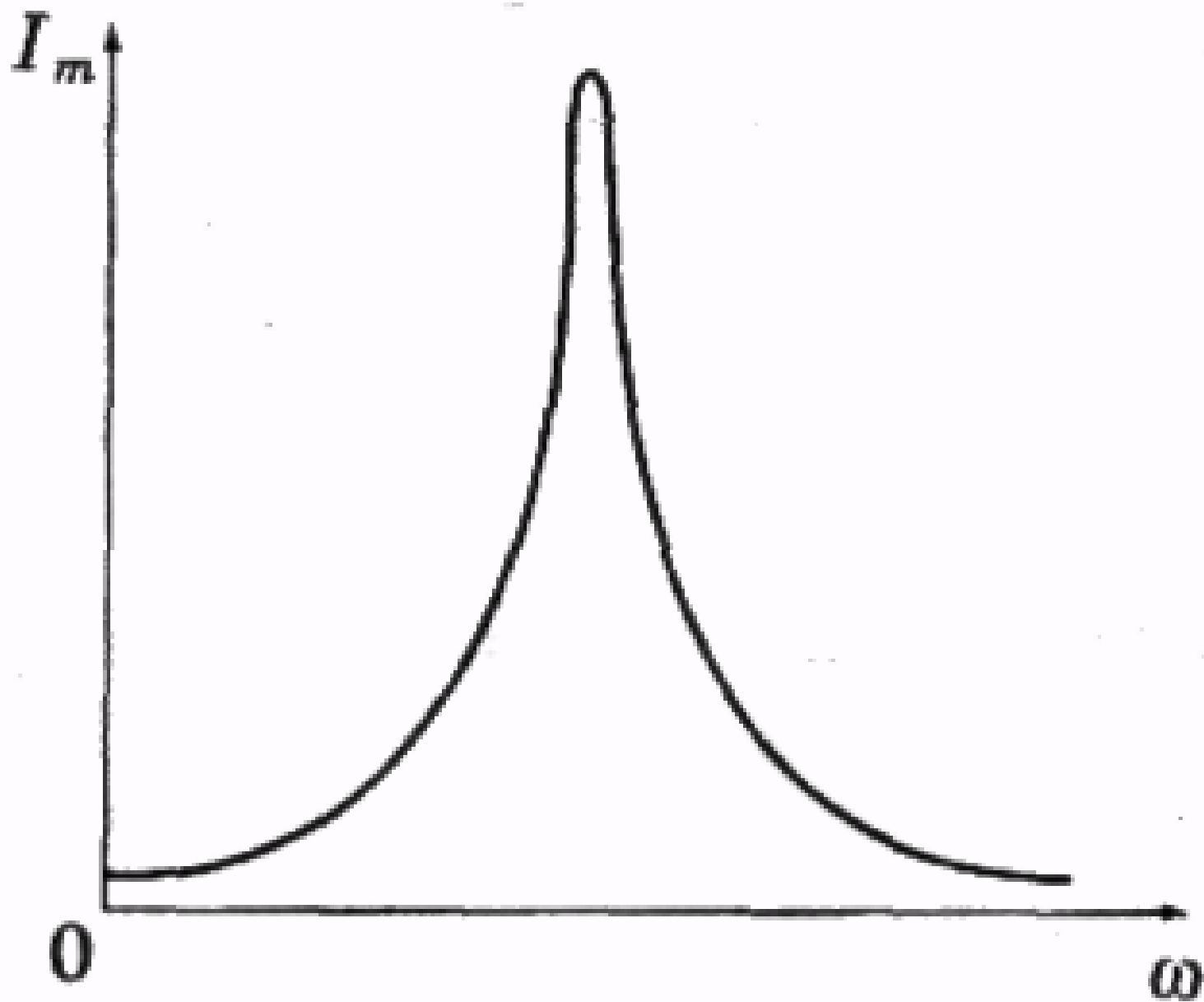

Мал. 2.165

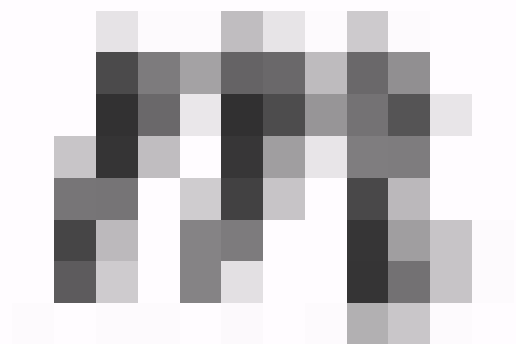
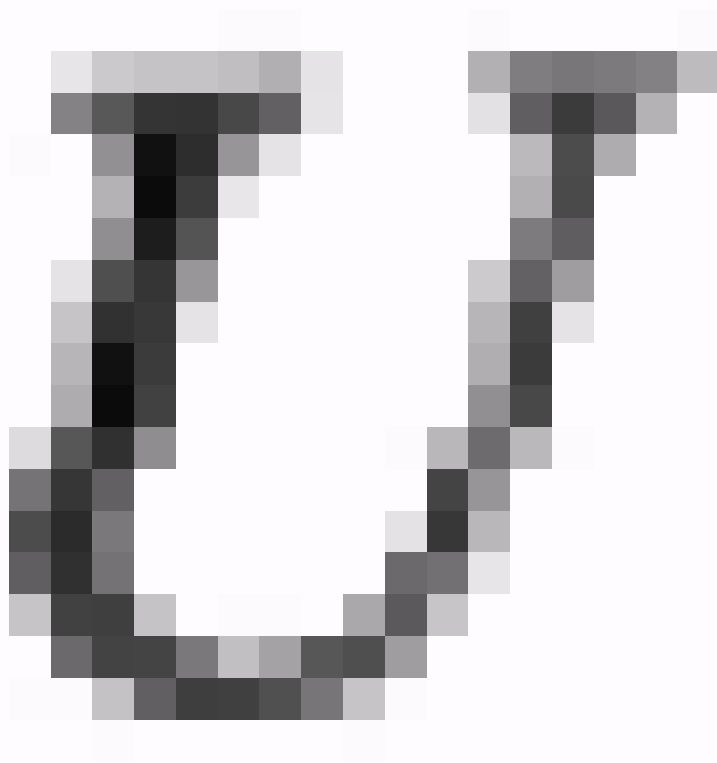

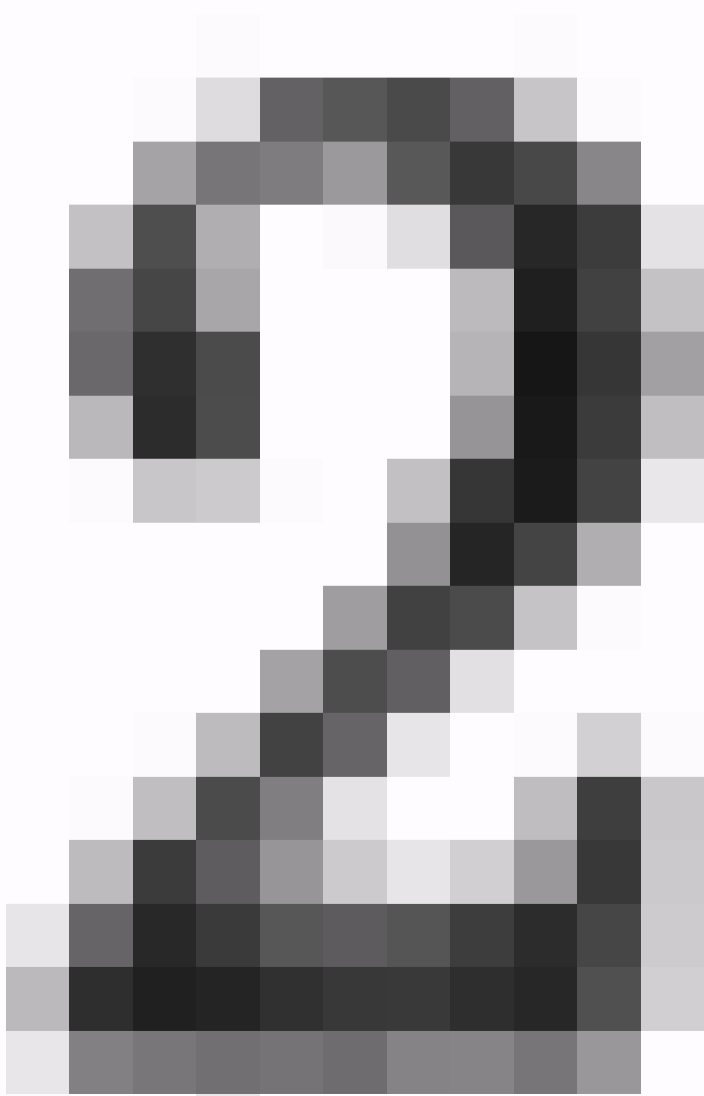
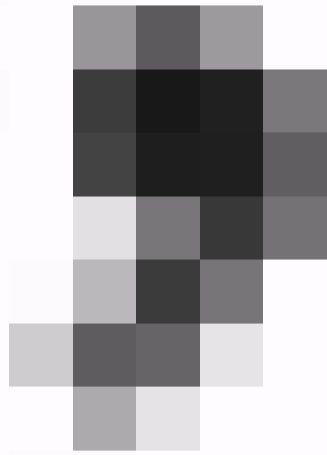
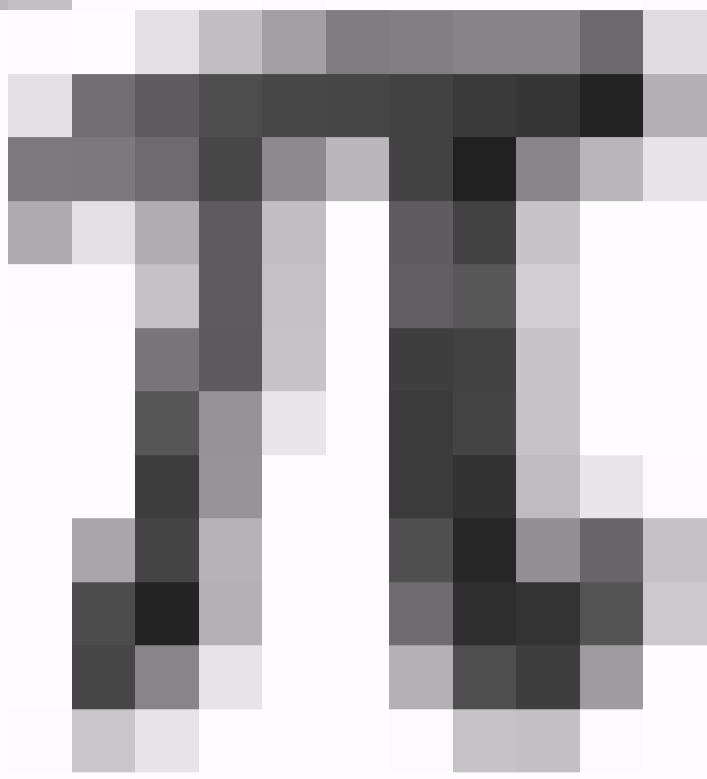
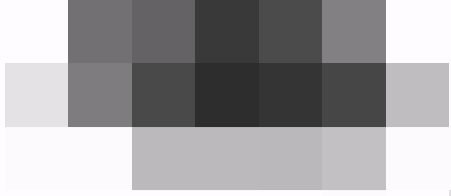



V_m

=

$I_{wo} M$

(50.9)

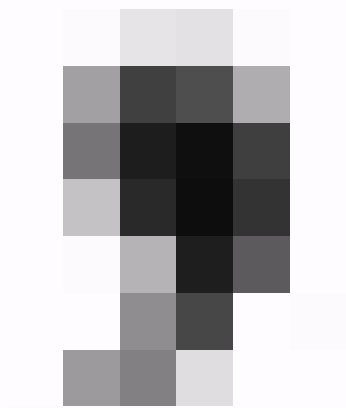
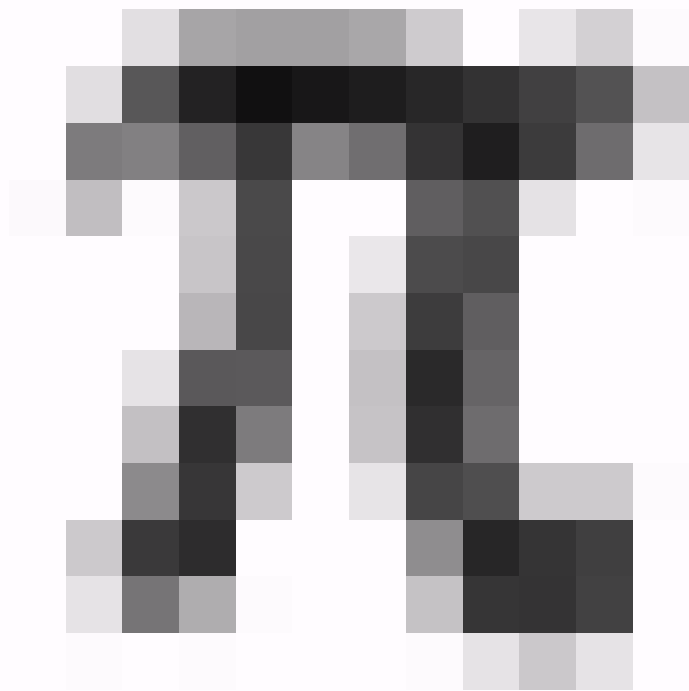

WORLDWIDE
WORLDWIDE

WORLDWIDE

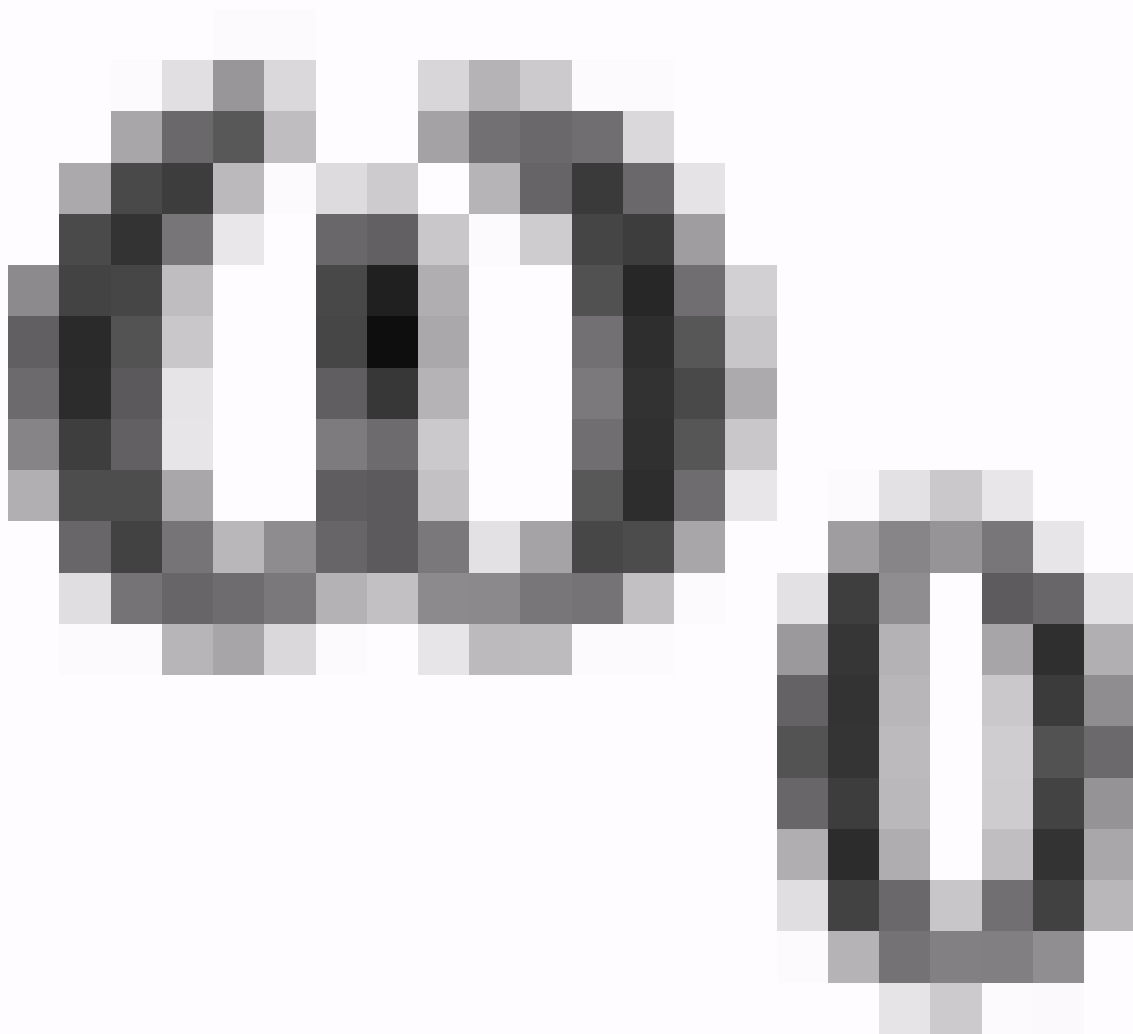

$$\omega_0 \mathcal{L} = \frac{1}{\omega_0 C} \quad (50.18)$$

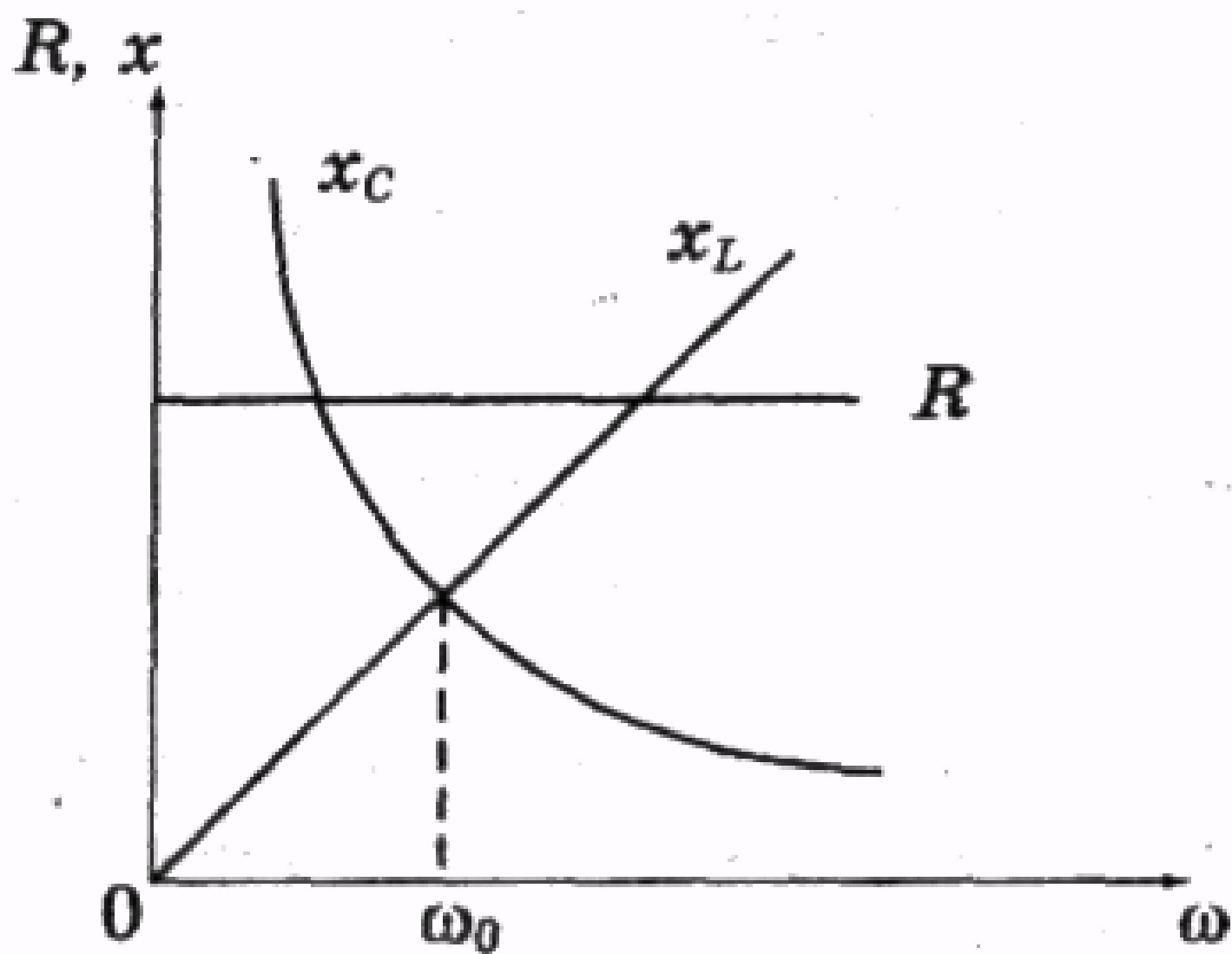

Мал. 2.166

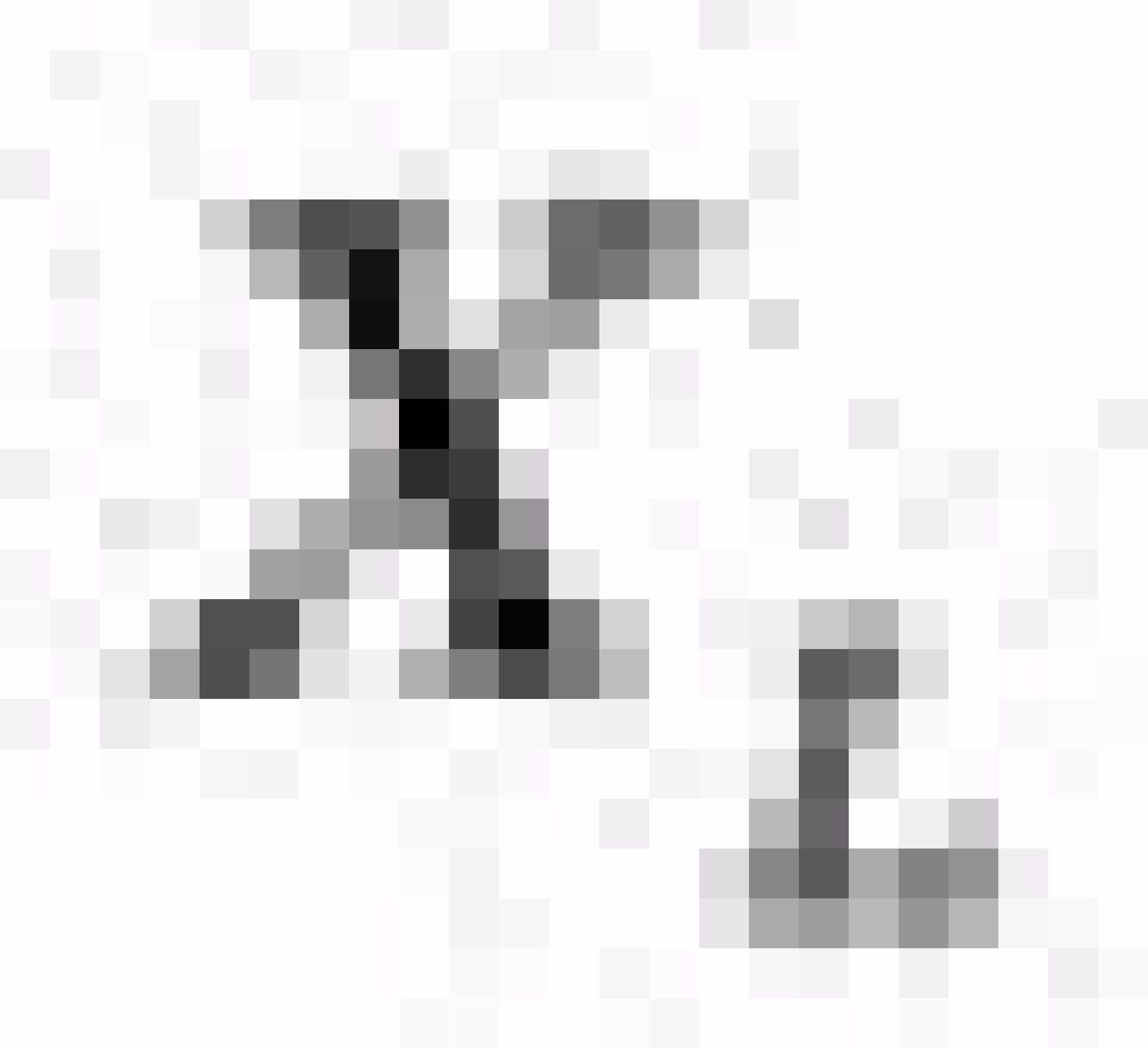

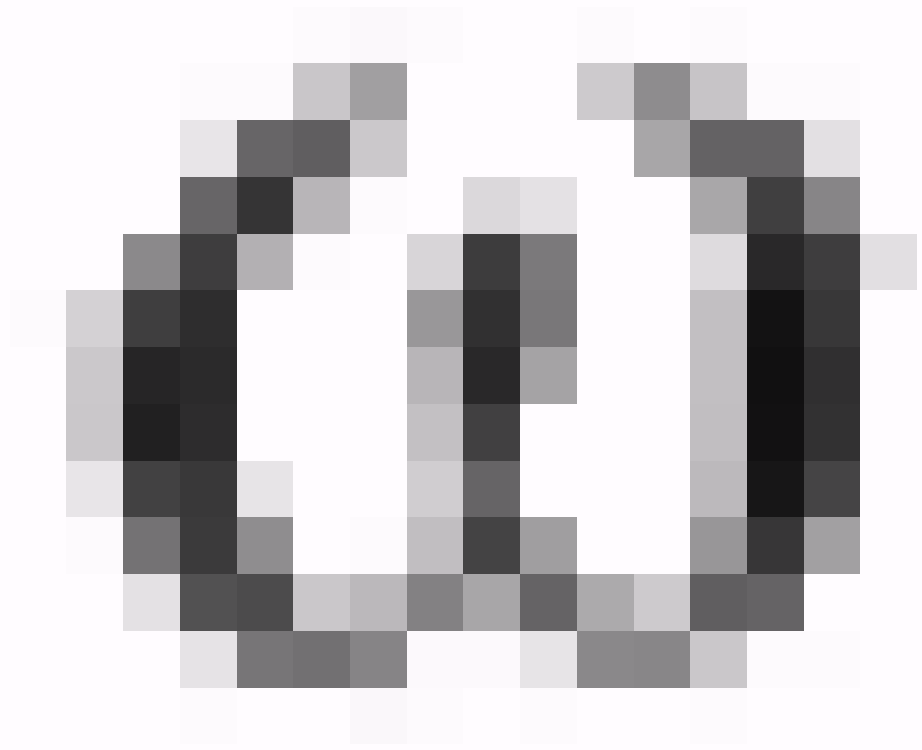

$$\omega_0 = \sqrt{\frac{1}{LC}}$$

(50.19)

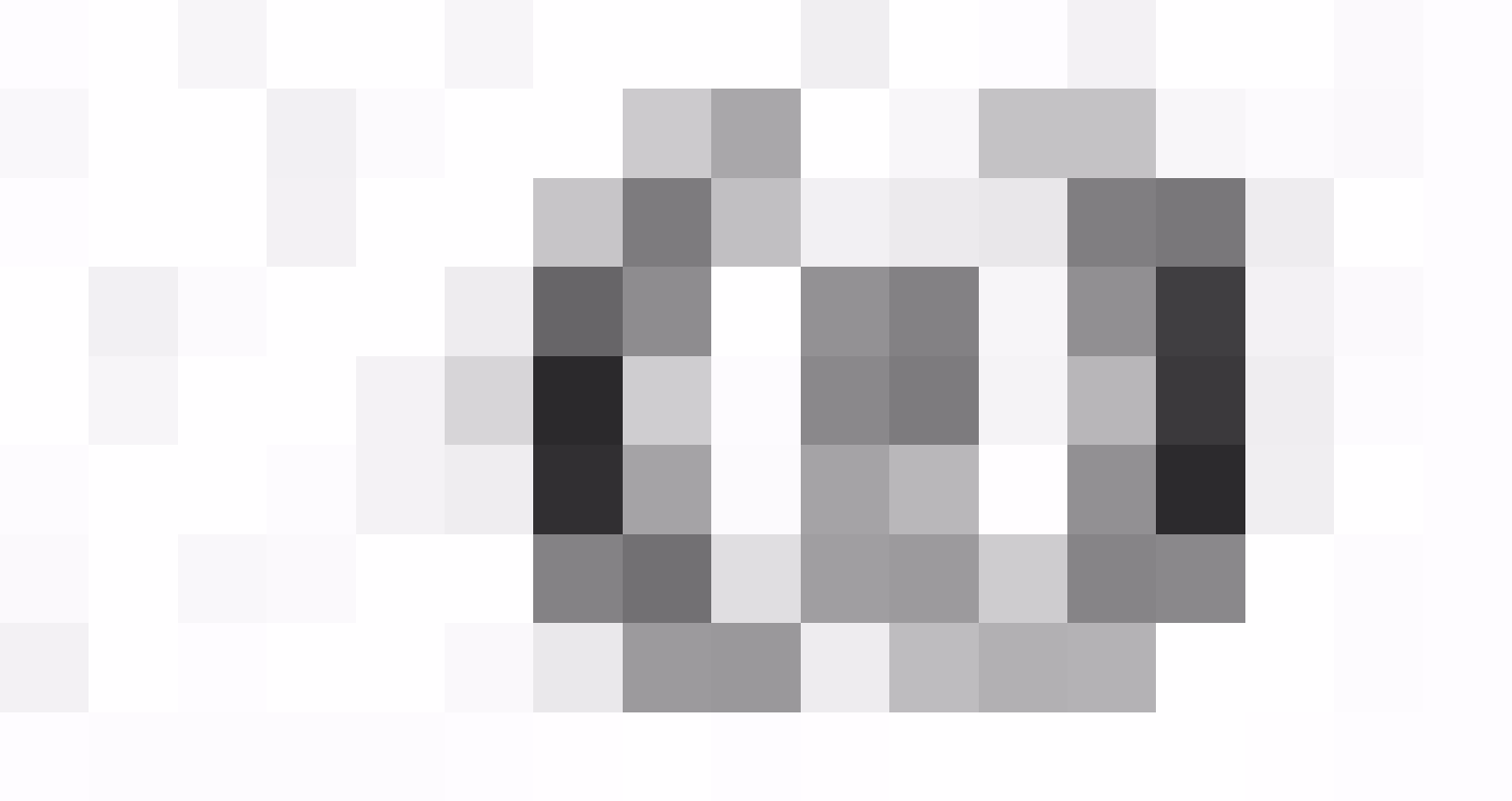



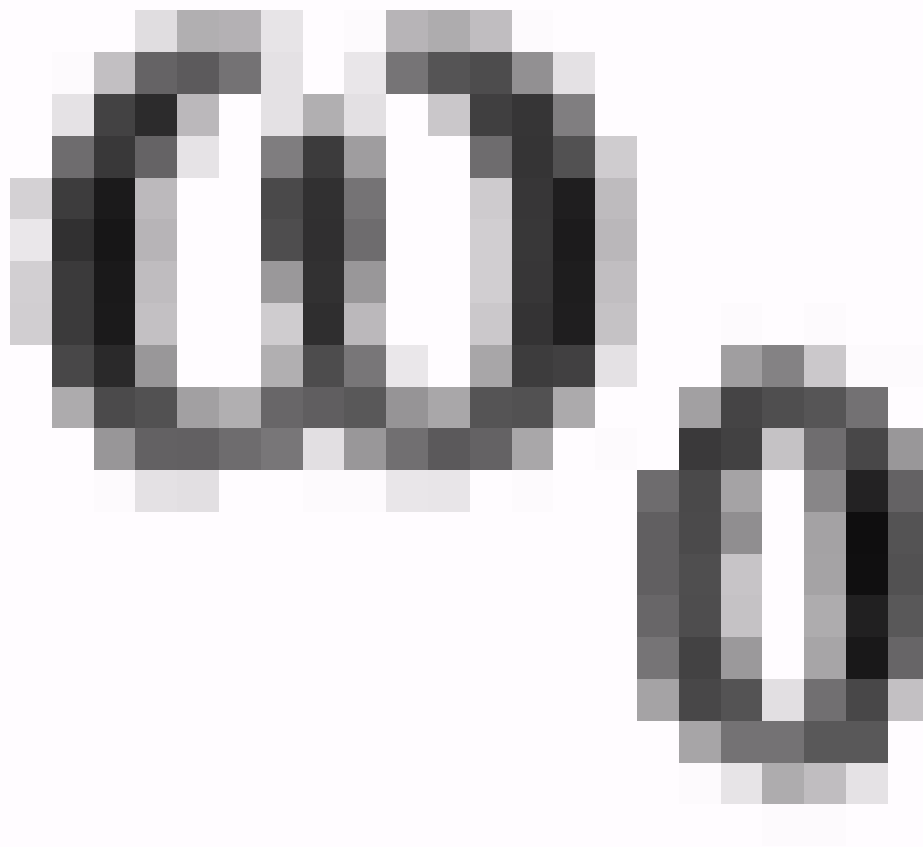

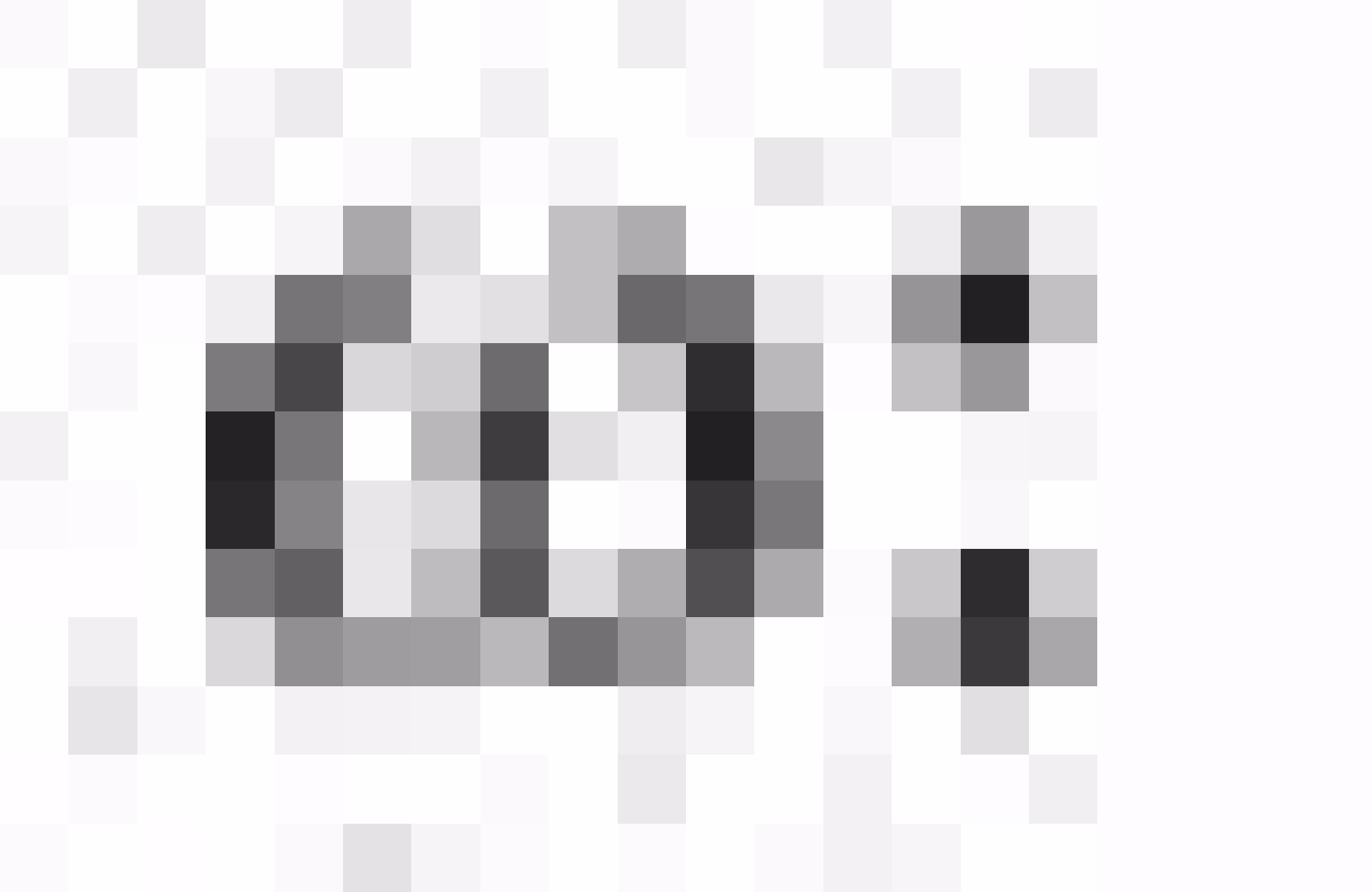

1990

U C

=

U L

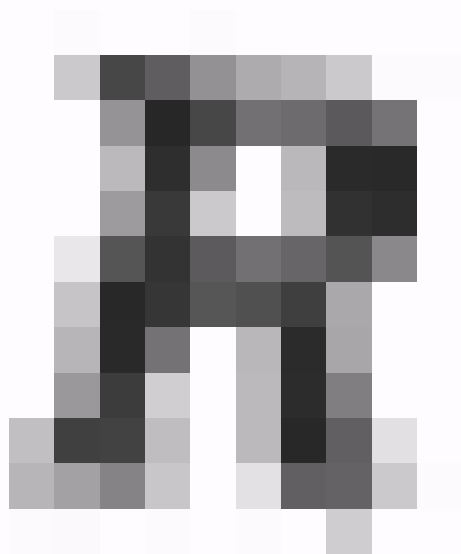
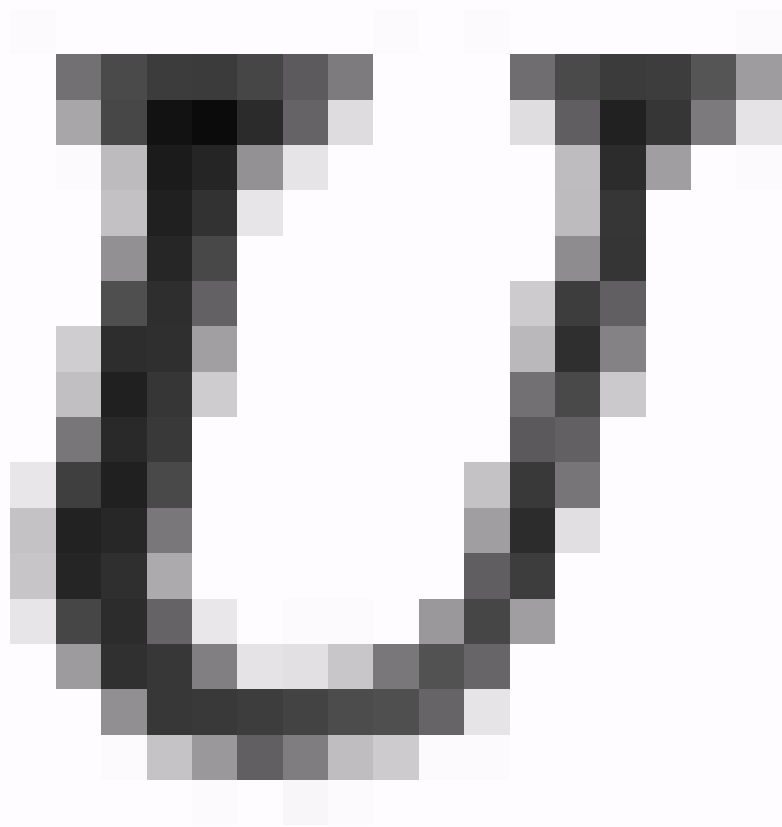

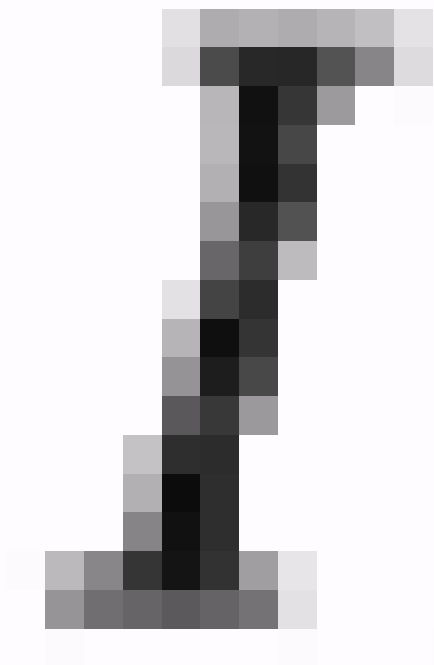



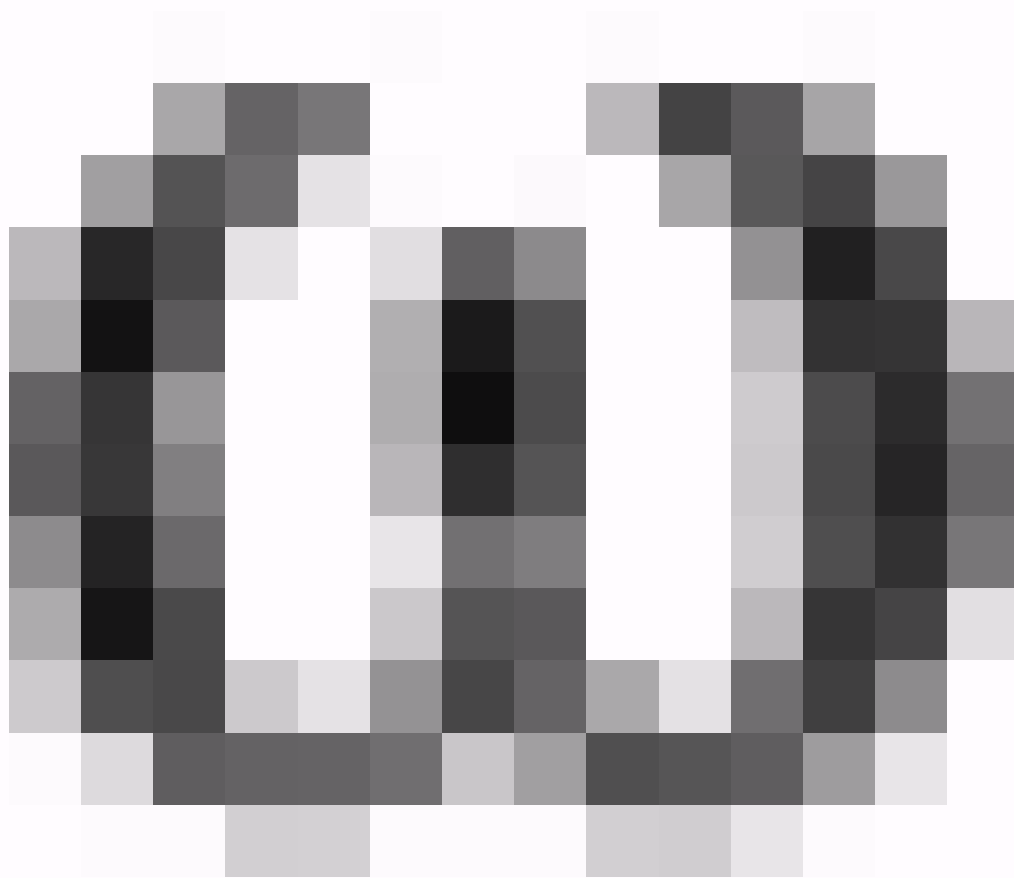

$$\int_{\mathcal{R}} \mathbf{1}_{\mathcal{R}} = \frac{U}{R} = \frac{U}{R} \quad (50.20).$$

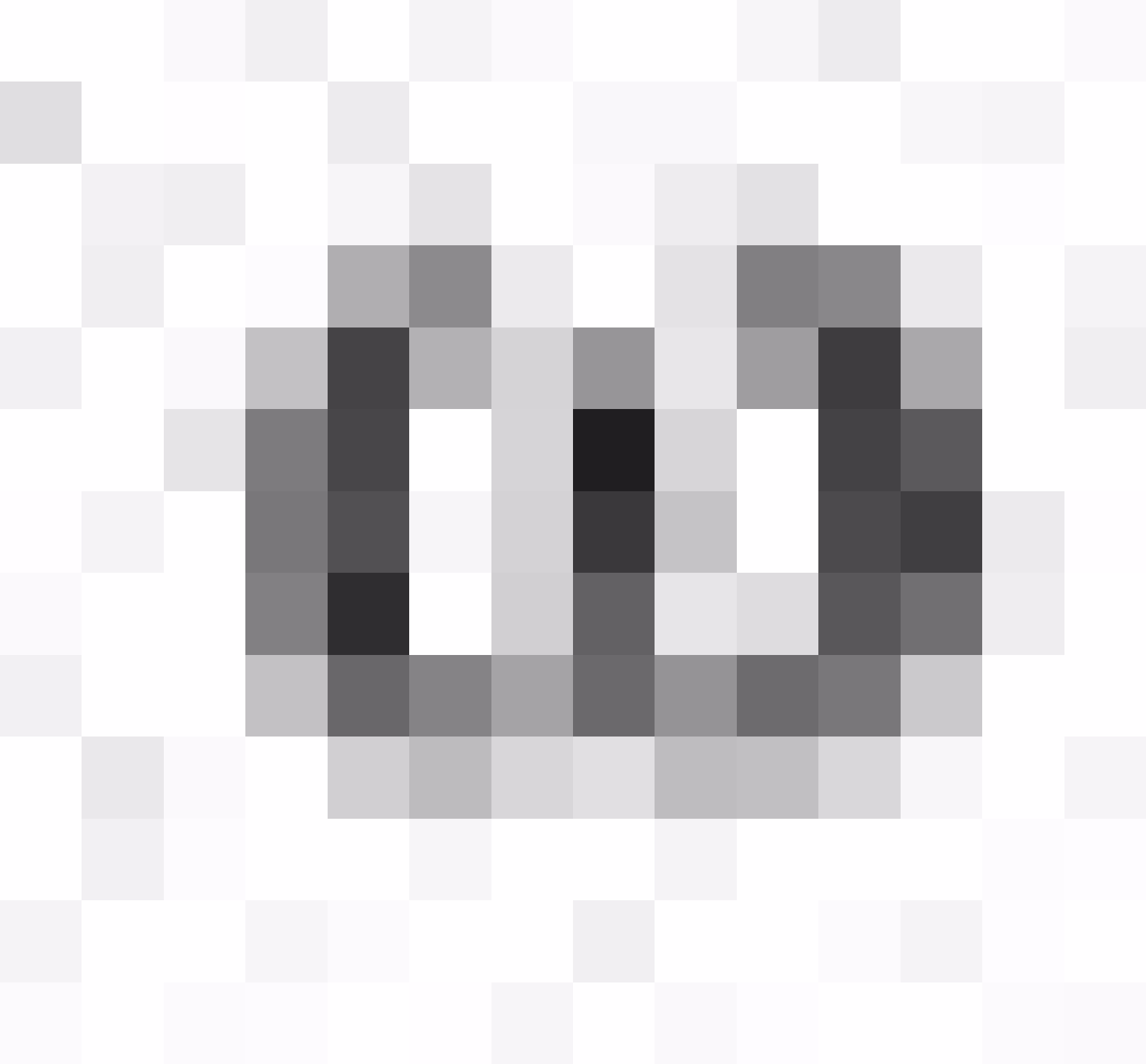

$$I_m = \frac{U_m}{X_L} \quad (50.11)$$

100

100

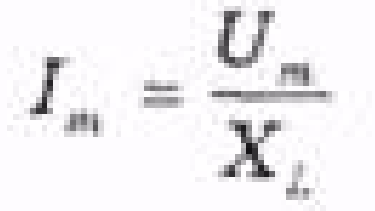

050111

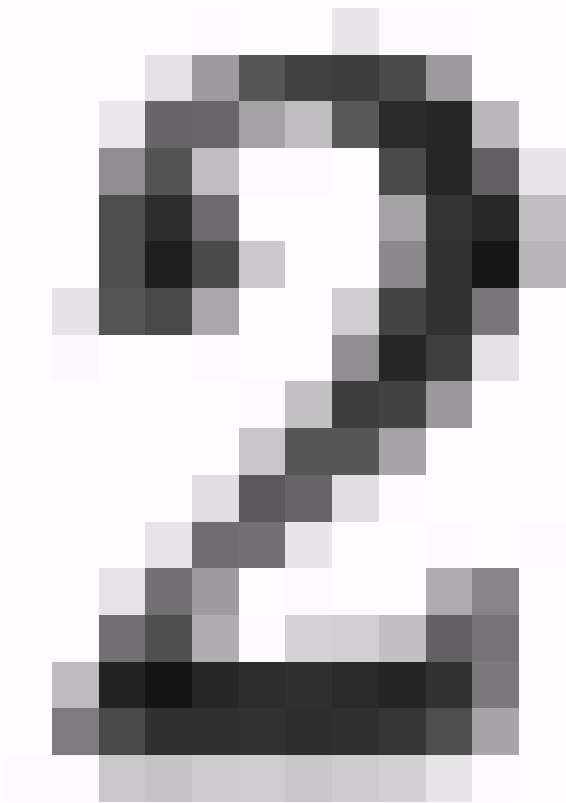
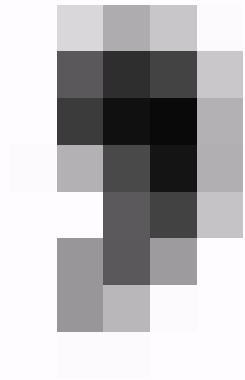
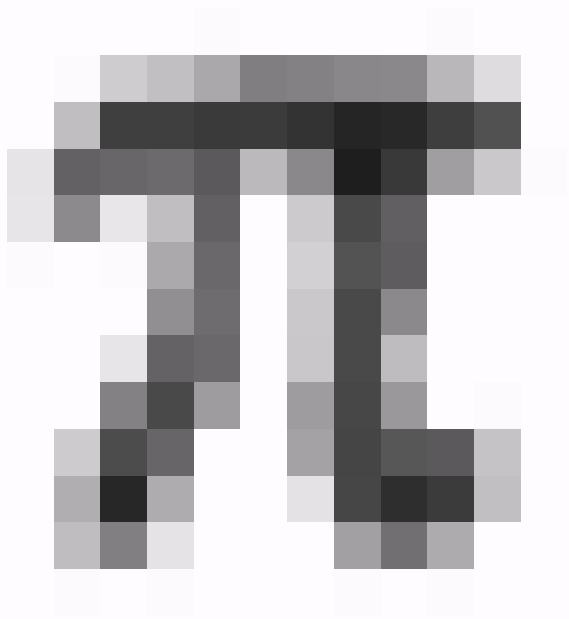

AP

=

IRP

(51.1)



$$i = I_m \cos \omega t, \quad u = U_m \cos \omega t$$

$$R = \frac{U_m}{I_m} \quad (50.12).$$

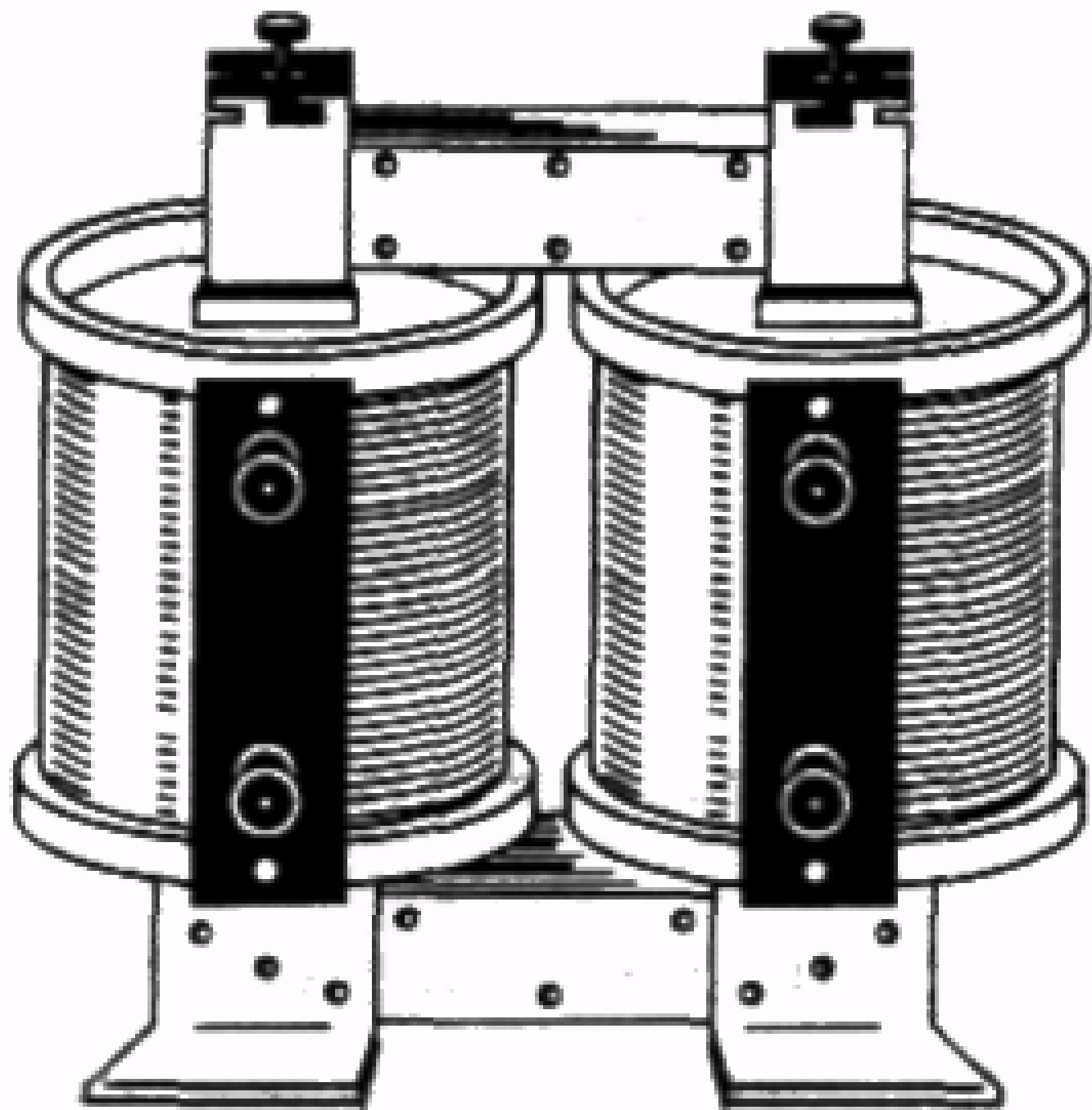

Мал. 2.167

$$i = I_m \cos \omega t, \quad u = U_m \cos \omega t$$

$$R = \frac{U_m}{I_m} \quad (50.12)$$

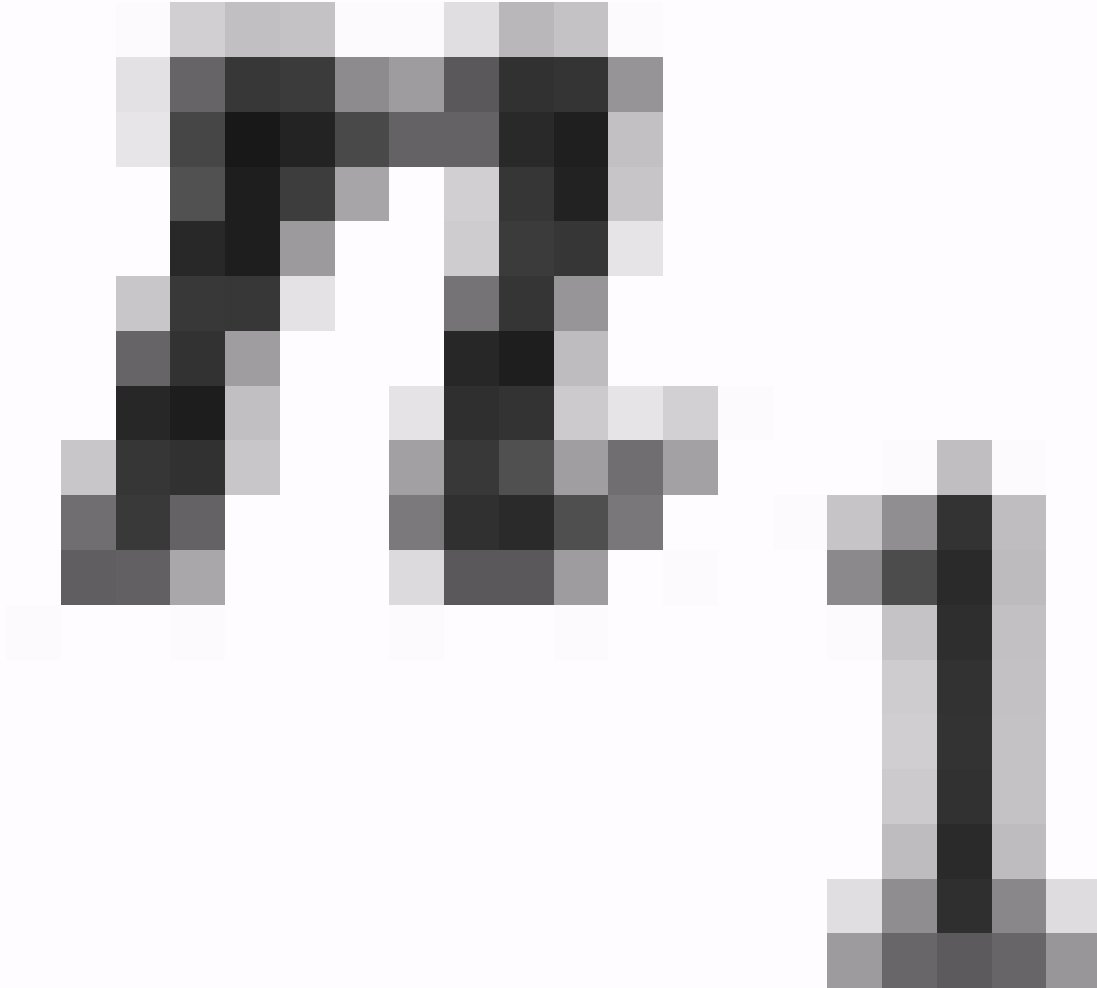

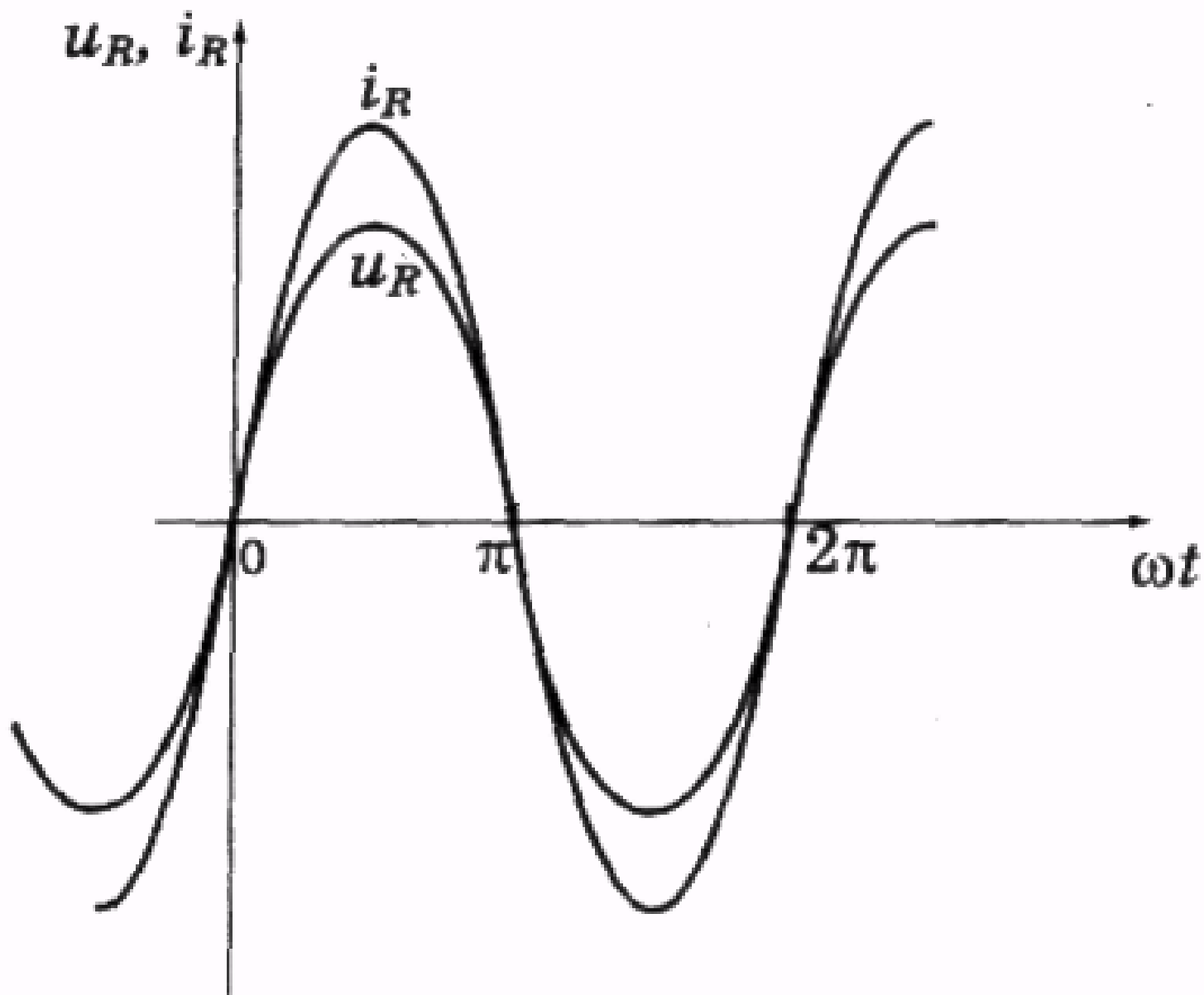

Мал. 2.163

er

—

erri

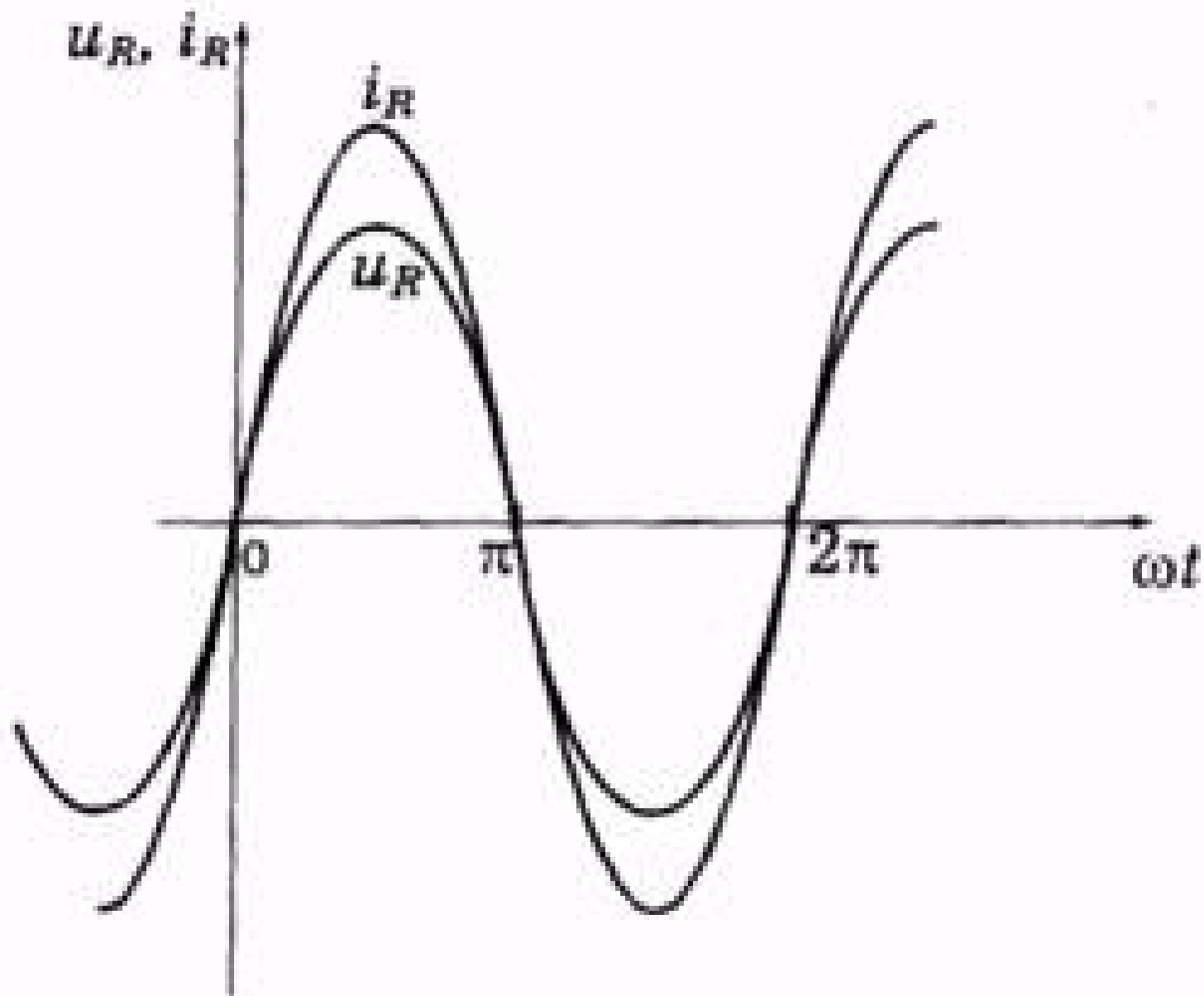

Мал. 2.163

COOPER

WORLD

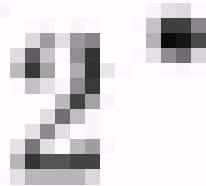
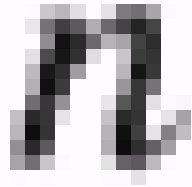



$$\bar{P} = \frac{IUV}{2}$$

(50.14).

$$\frac{e_1}{\hbar} = \frac{\mu_1}{\hbar}$$

$$e_2 = \mu_2$$

(51.2).

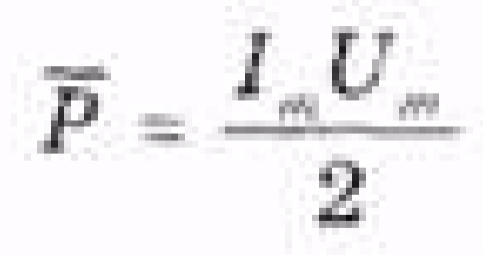

$$I = \frac{I_m}{\sqrt{2}}, \quad U = \frac{U_m}{\sqrt{2}} \quad (50.15 \text{ i } 50.16)$$

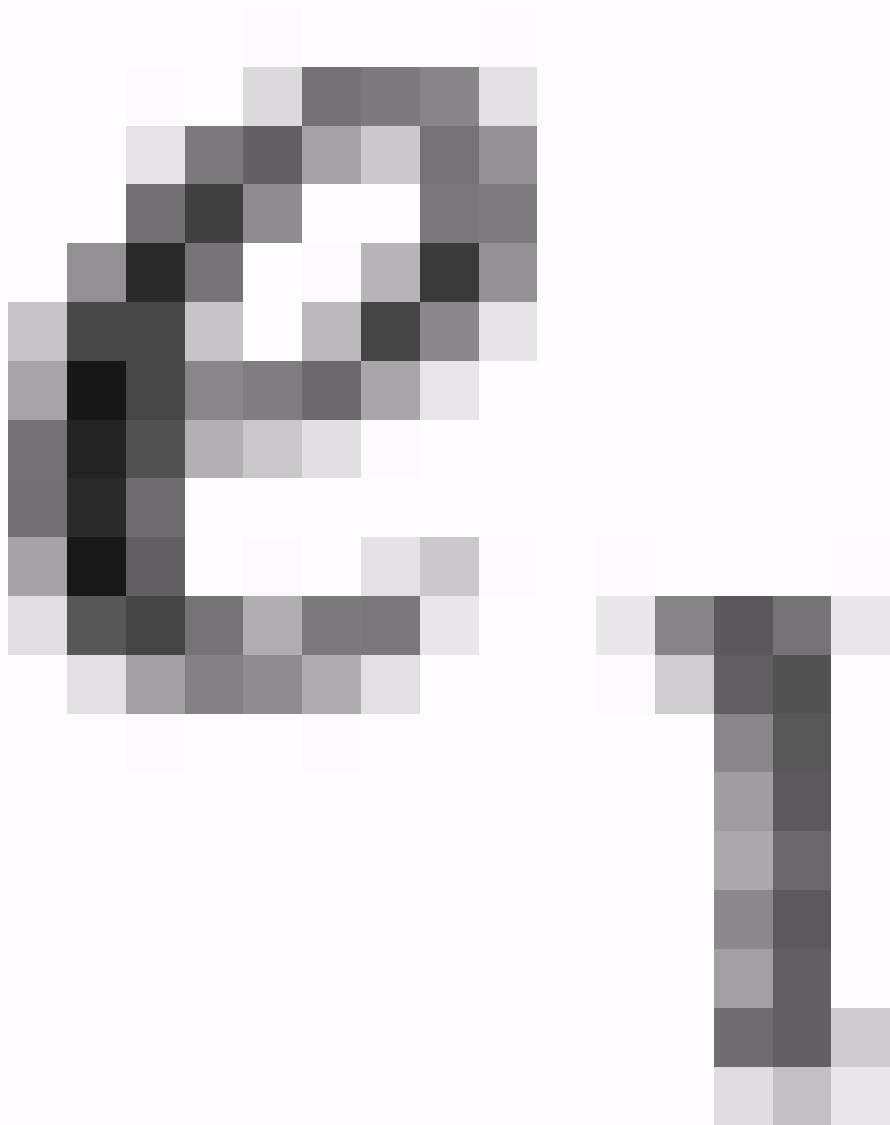

$$I = \frac{1}{\sqrt{2}}$$

$$U = \frac{1}{\sqrt{2}}$$

(50, 15, 150, 16)

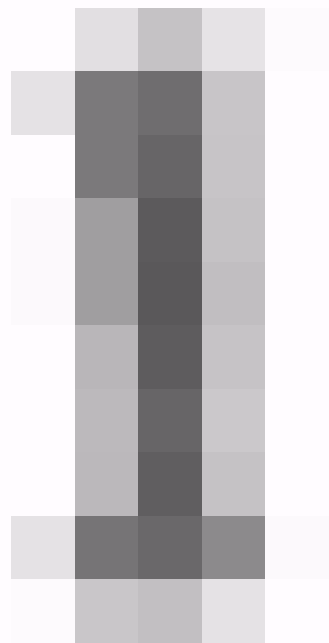
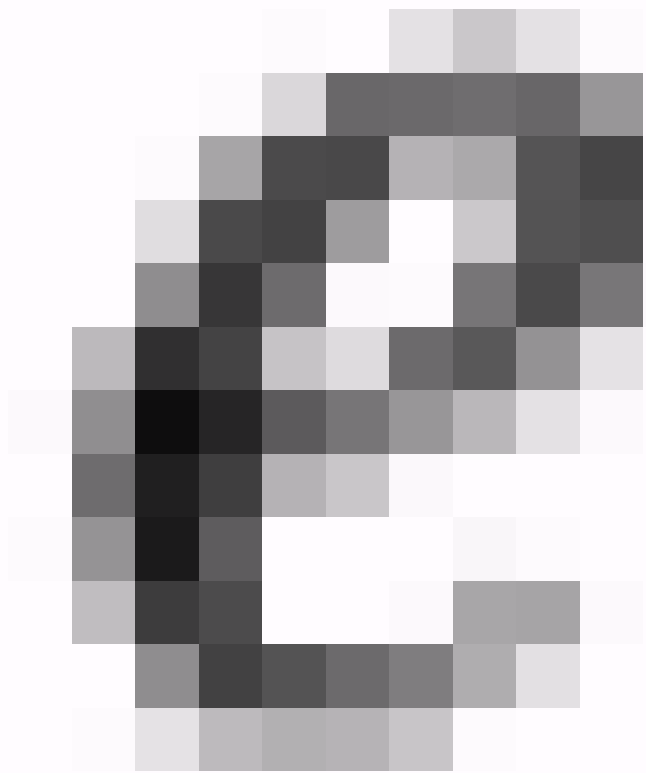

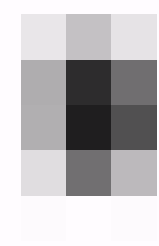
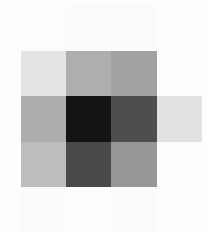
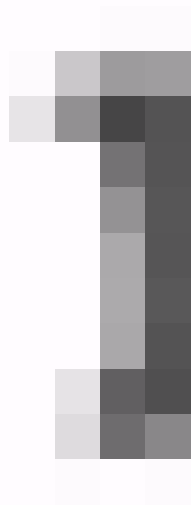
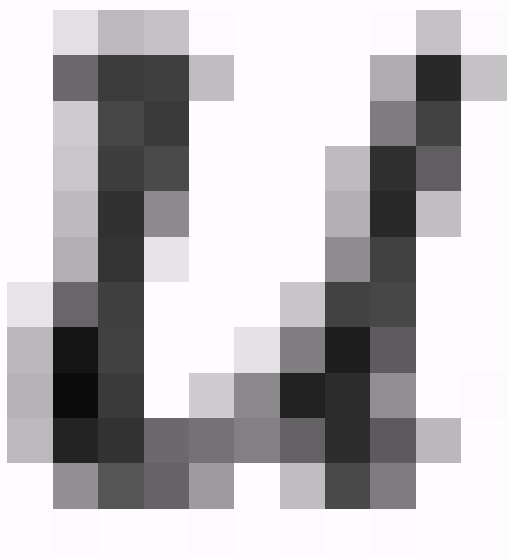

THE UNIVERSITY OF CHICAGO

WIP

(BIL3)

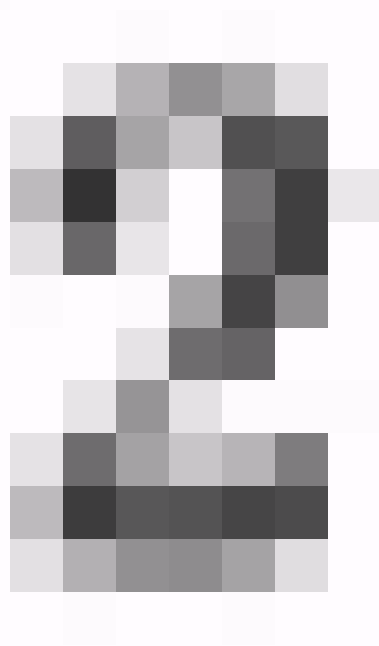
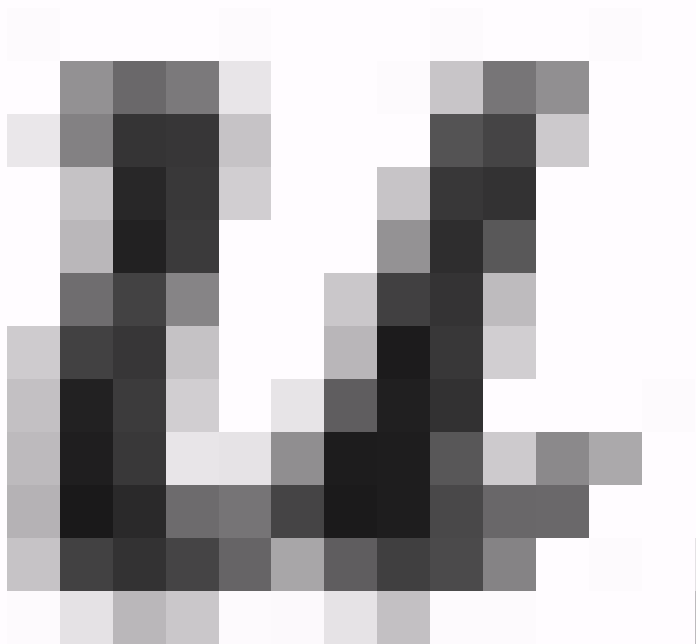

WORLD OF
GAMES



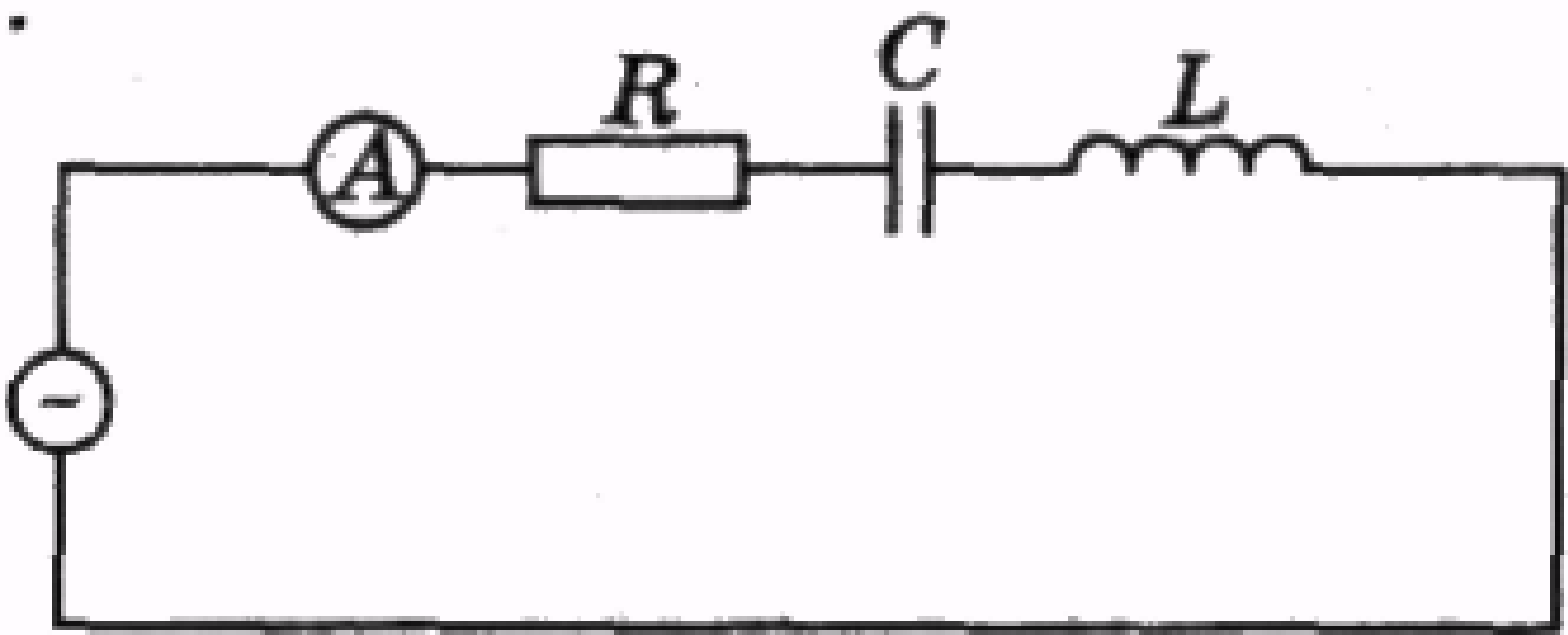

Мал. 2.164

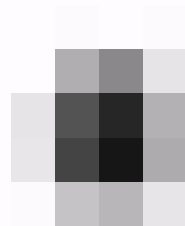
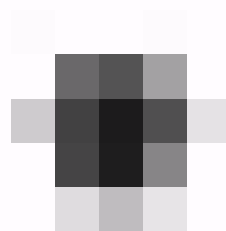
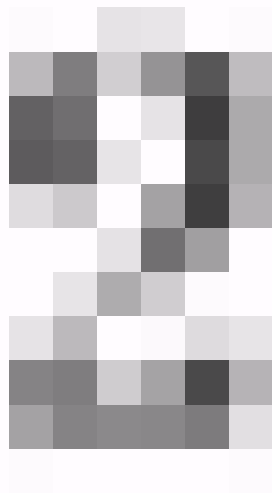
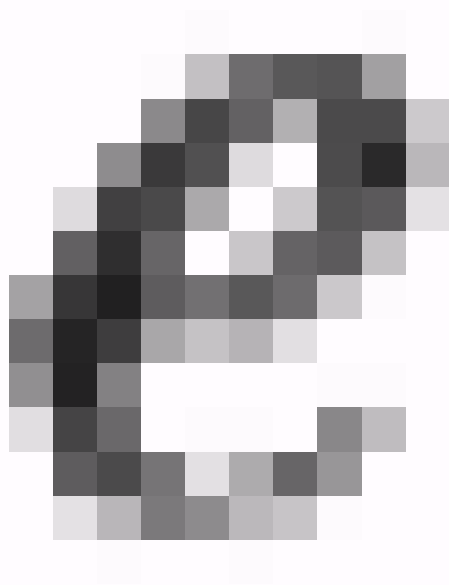

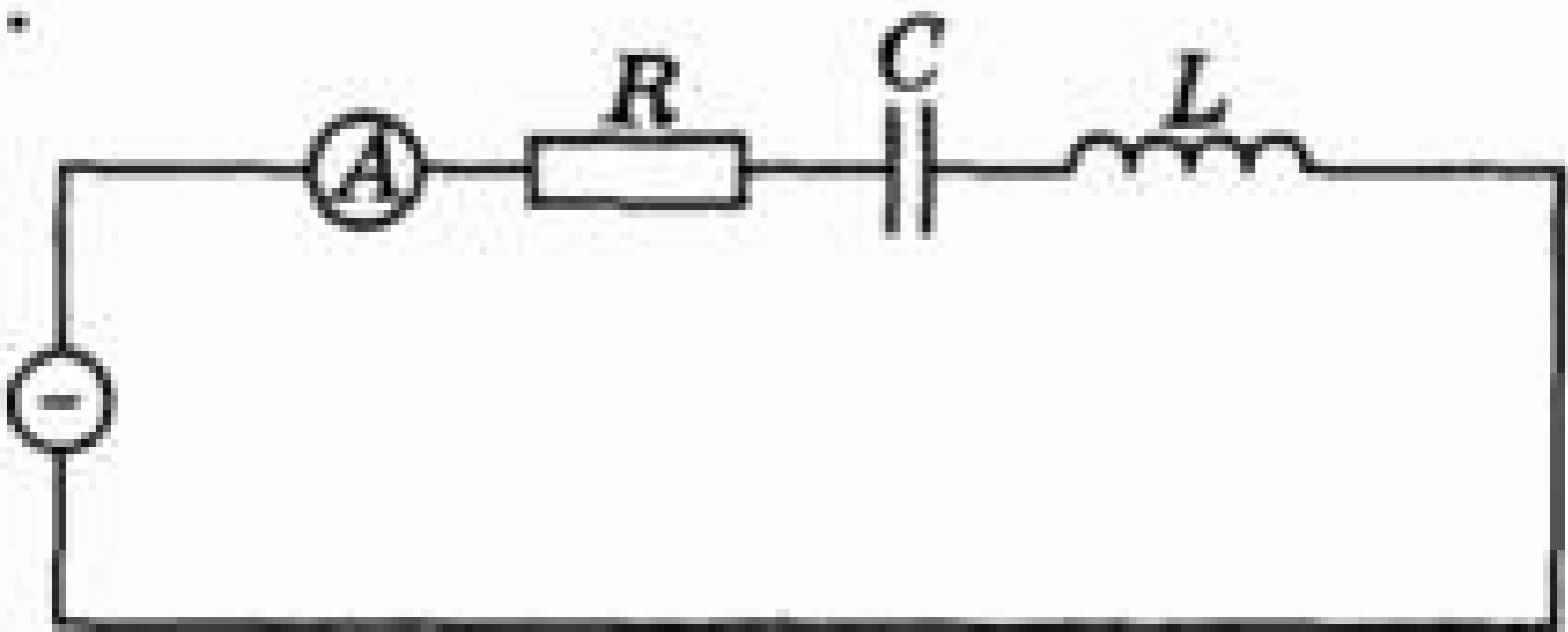

Mat. 2.164

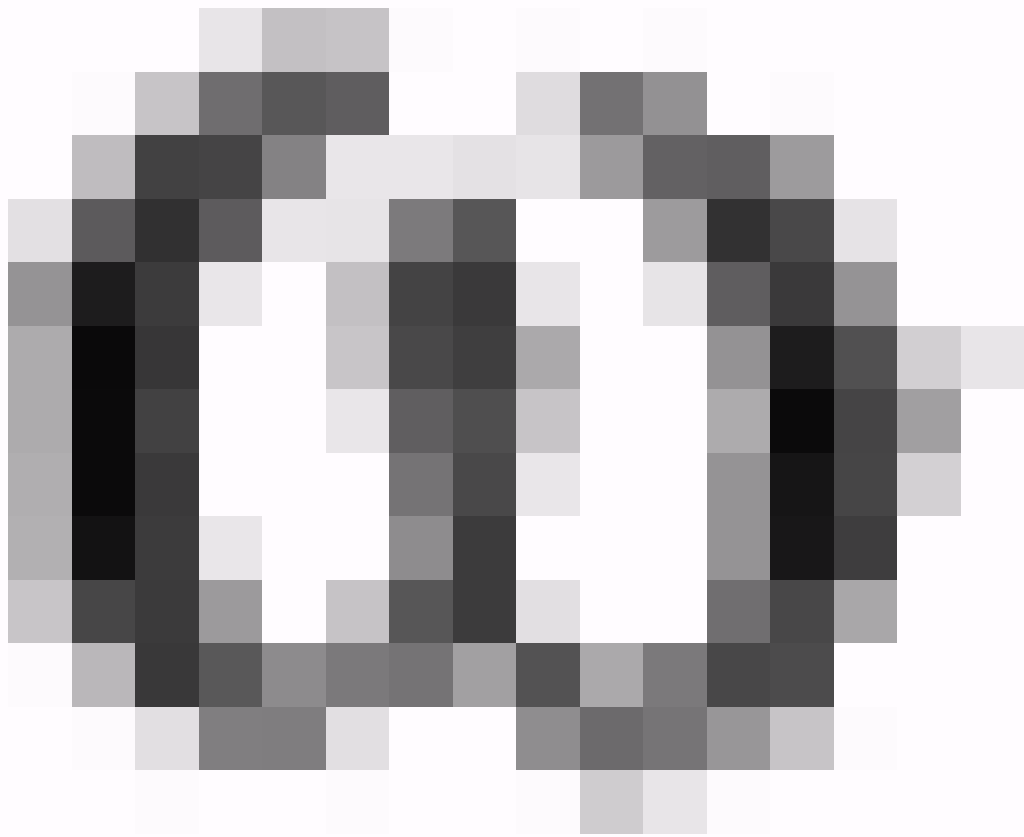

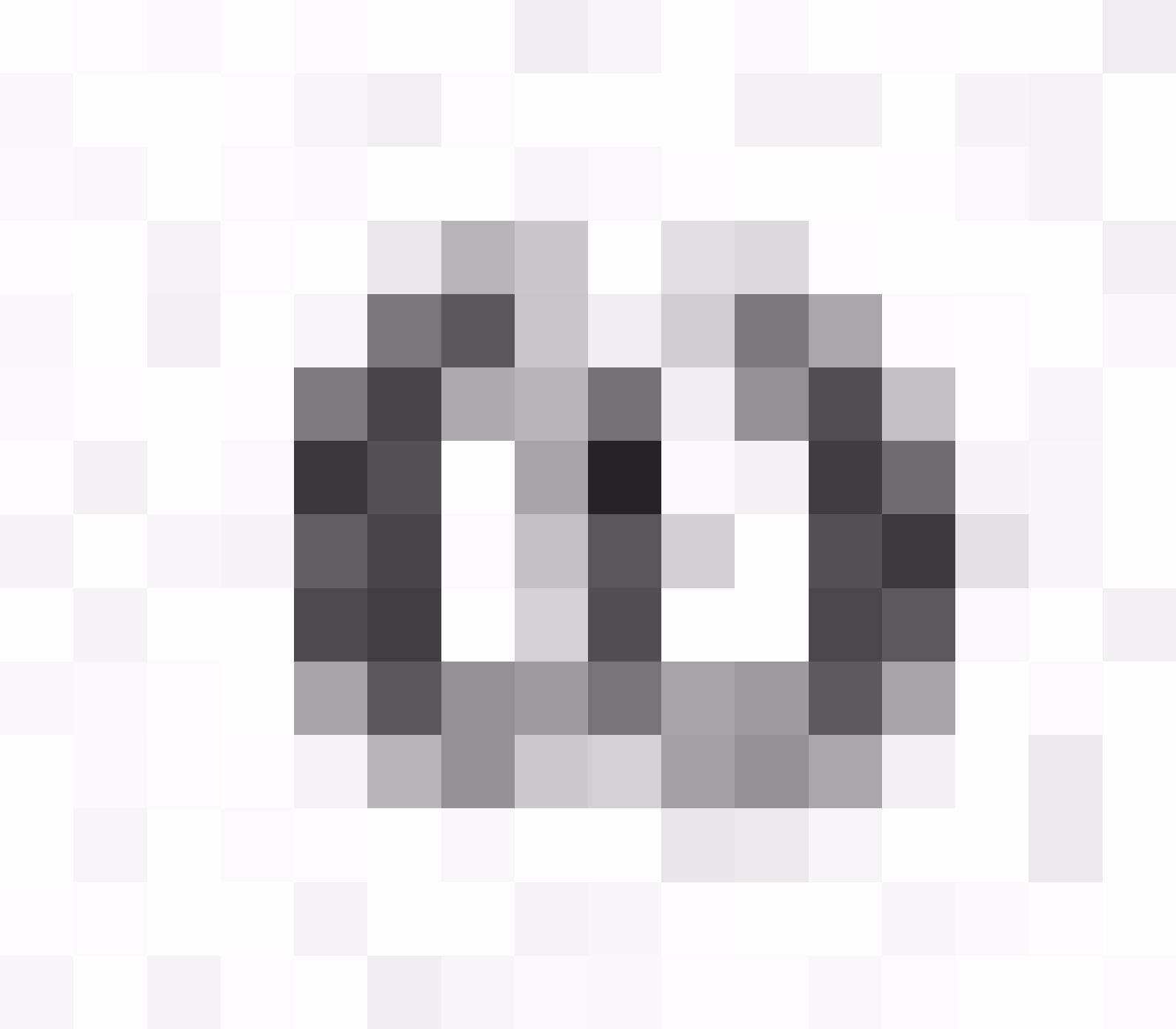

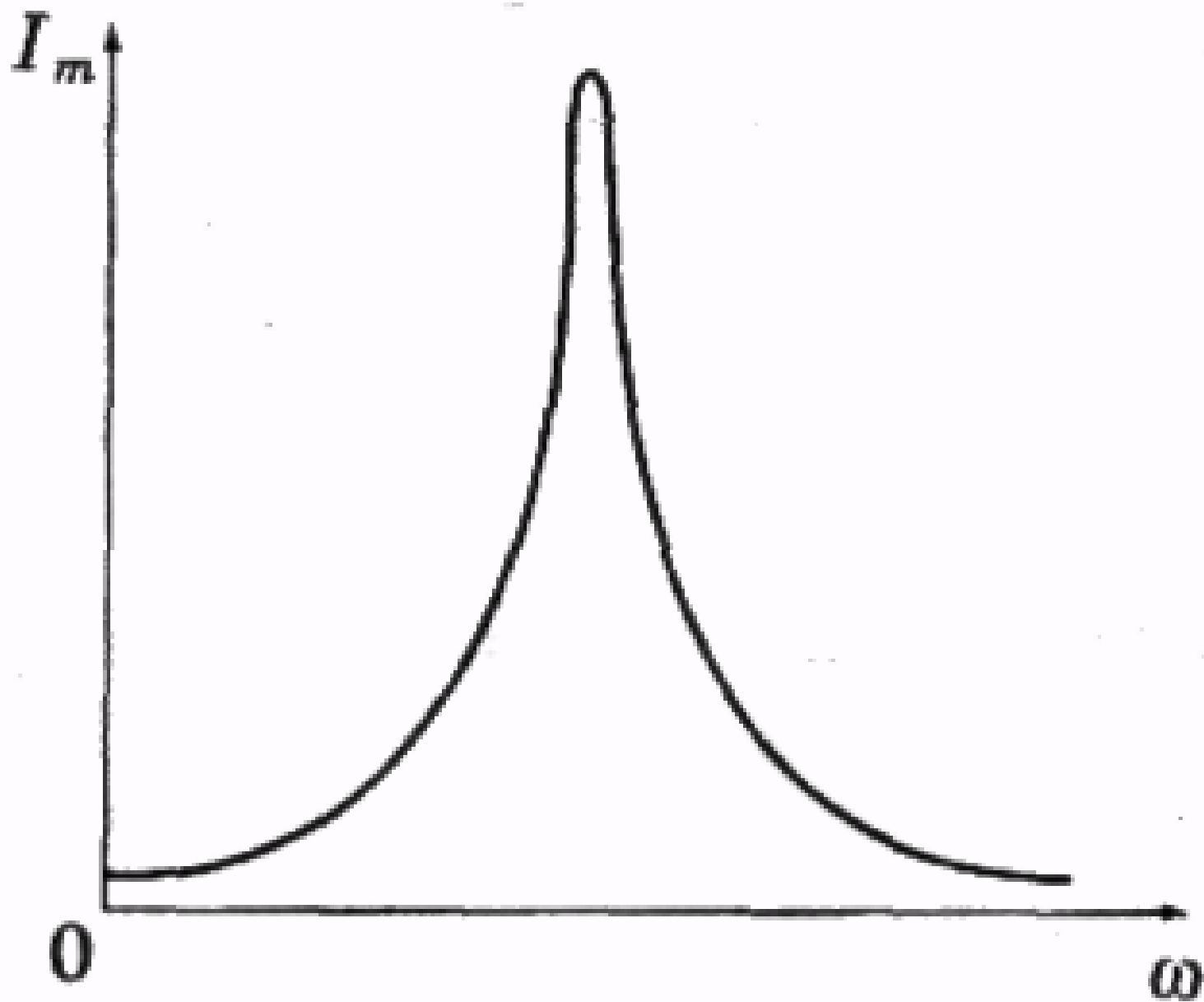

Мал. 2.165

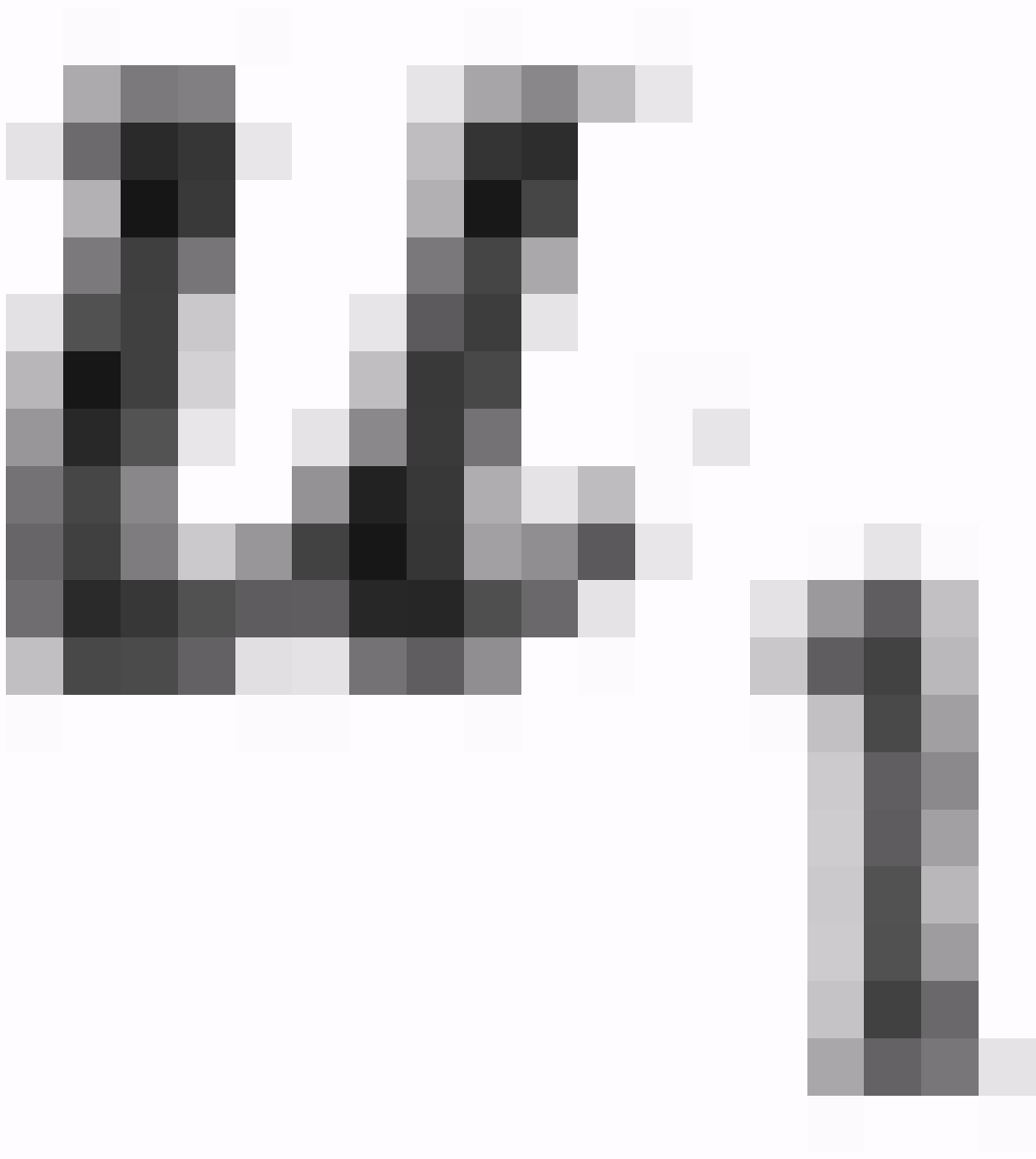

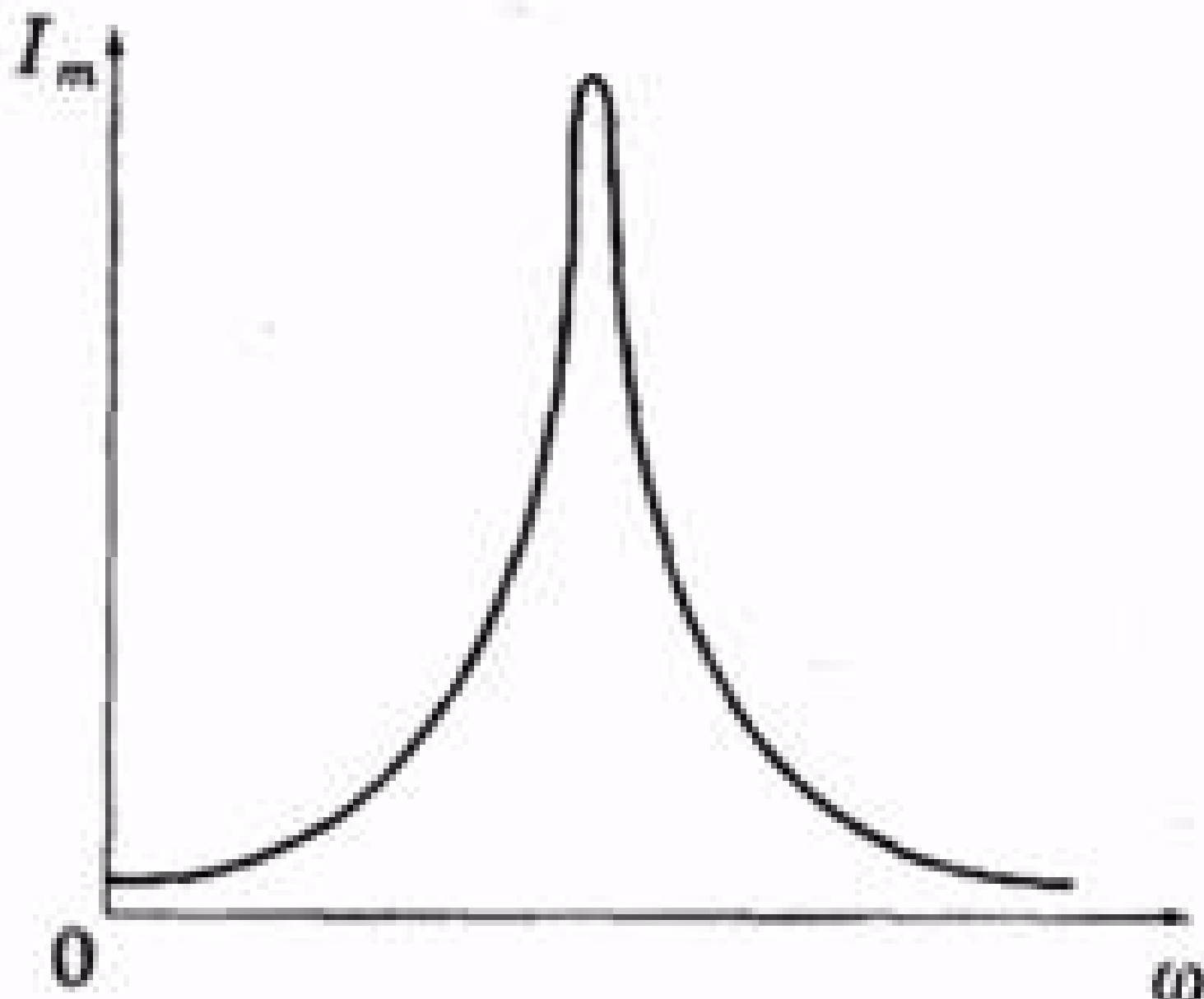

Мал. 2.165

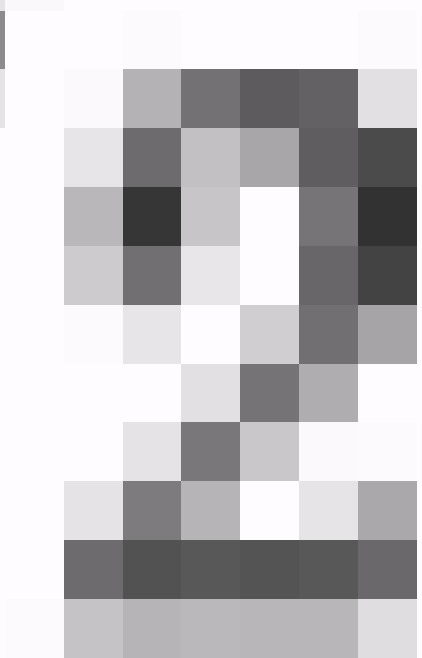
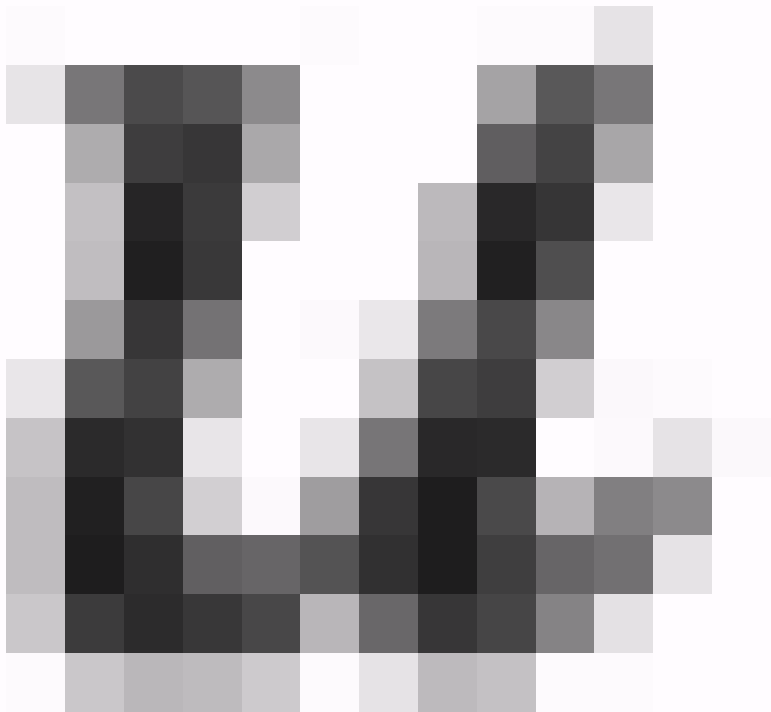

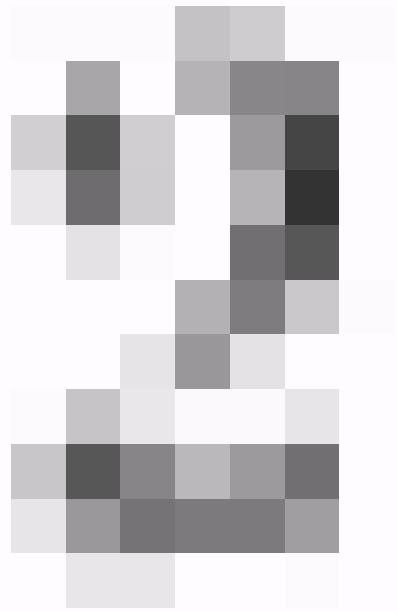
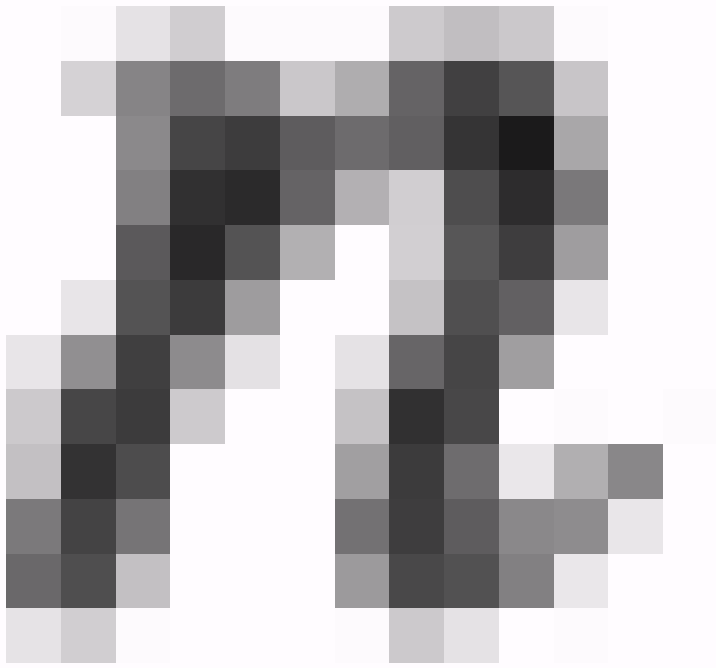

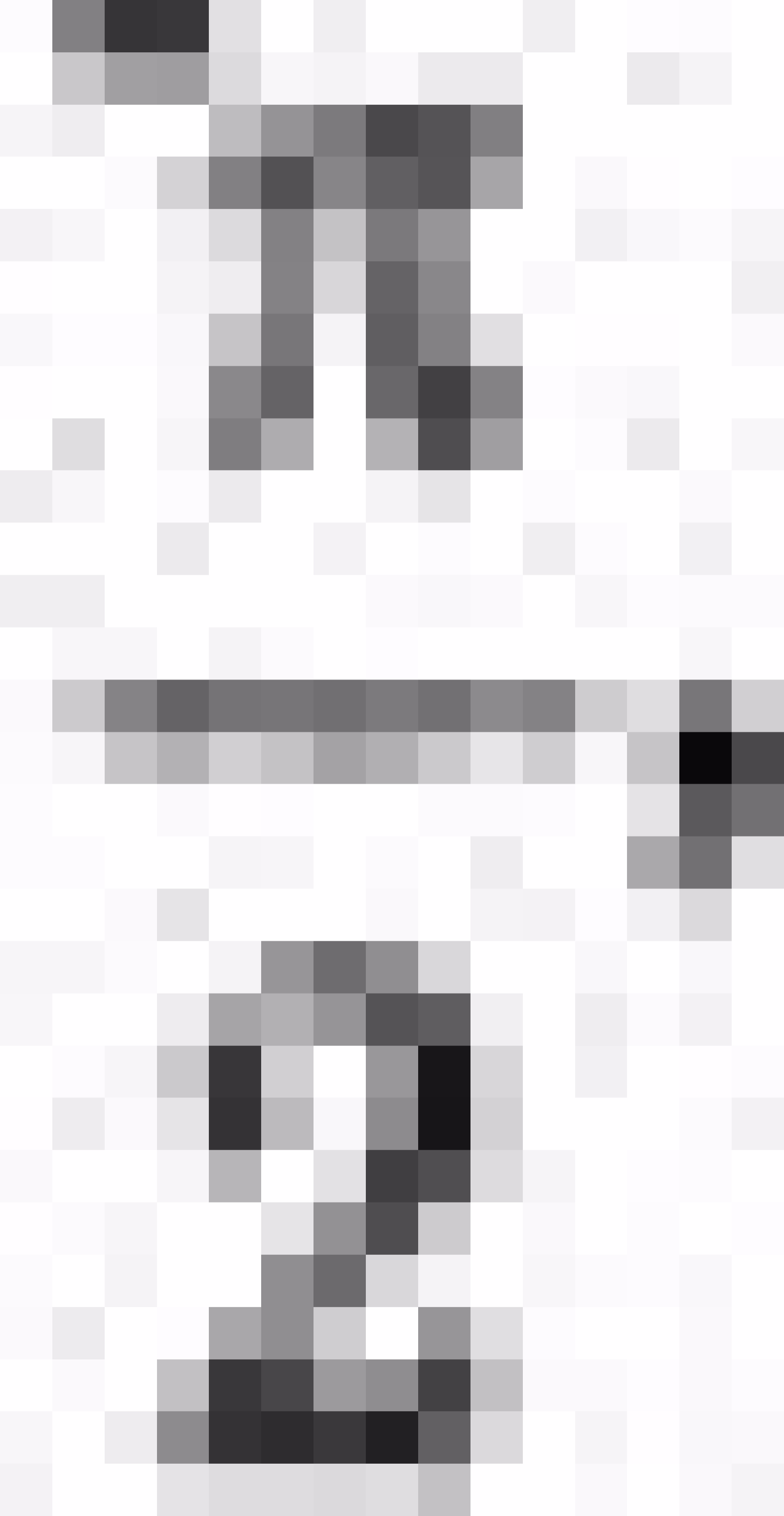

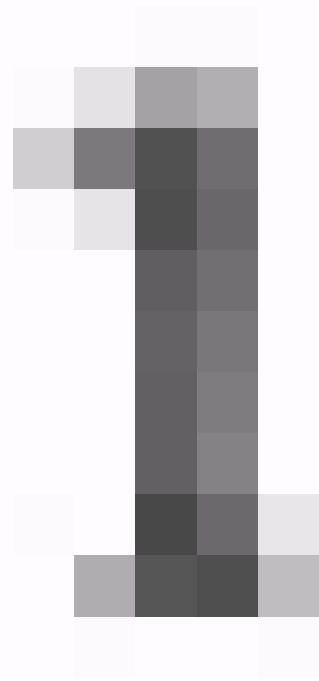
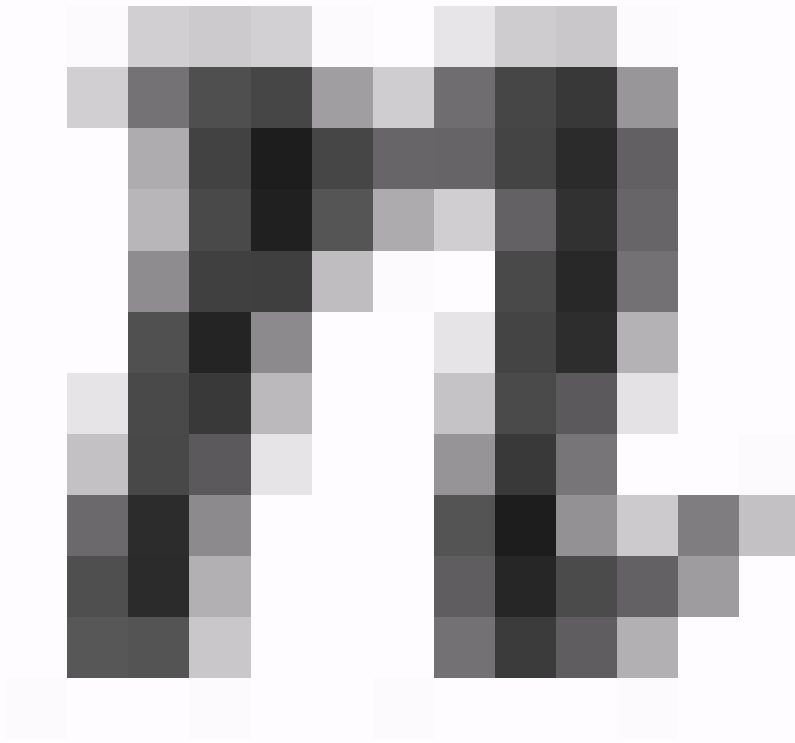

$$A = \frac{A_1}{A_2}$$

(51.6).

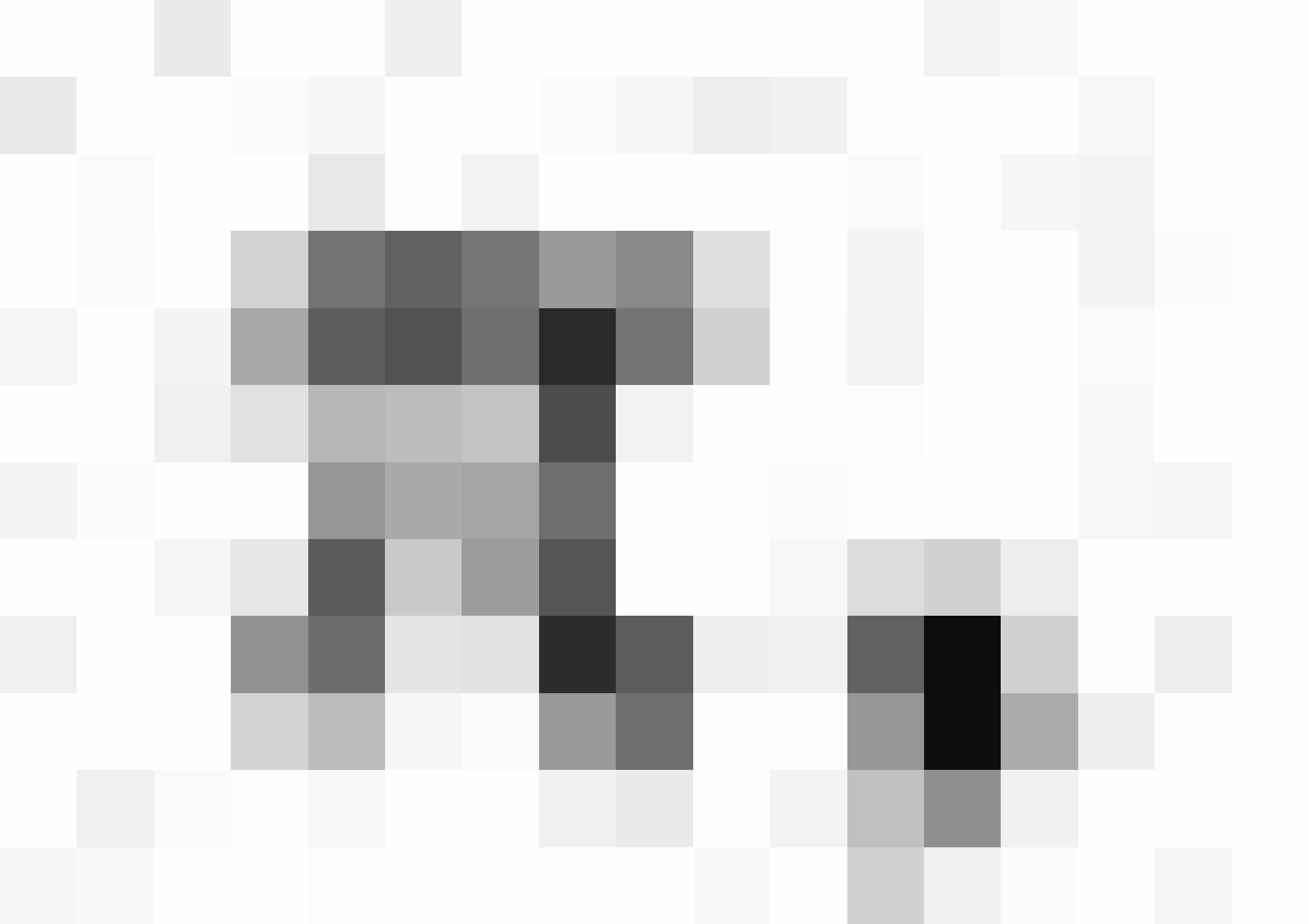

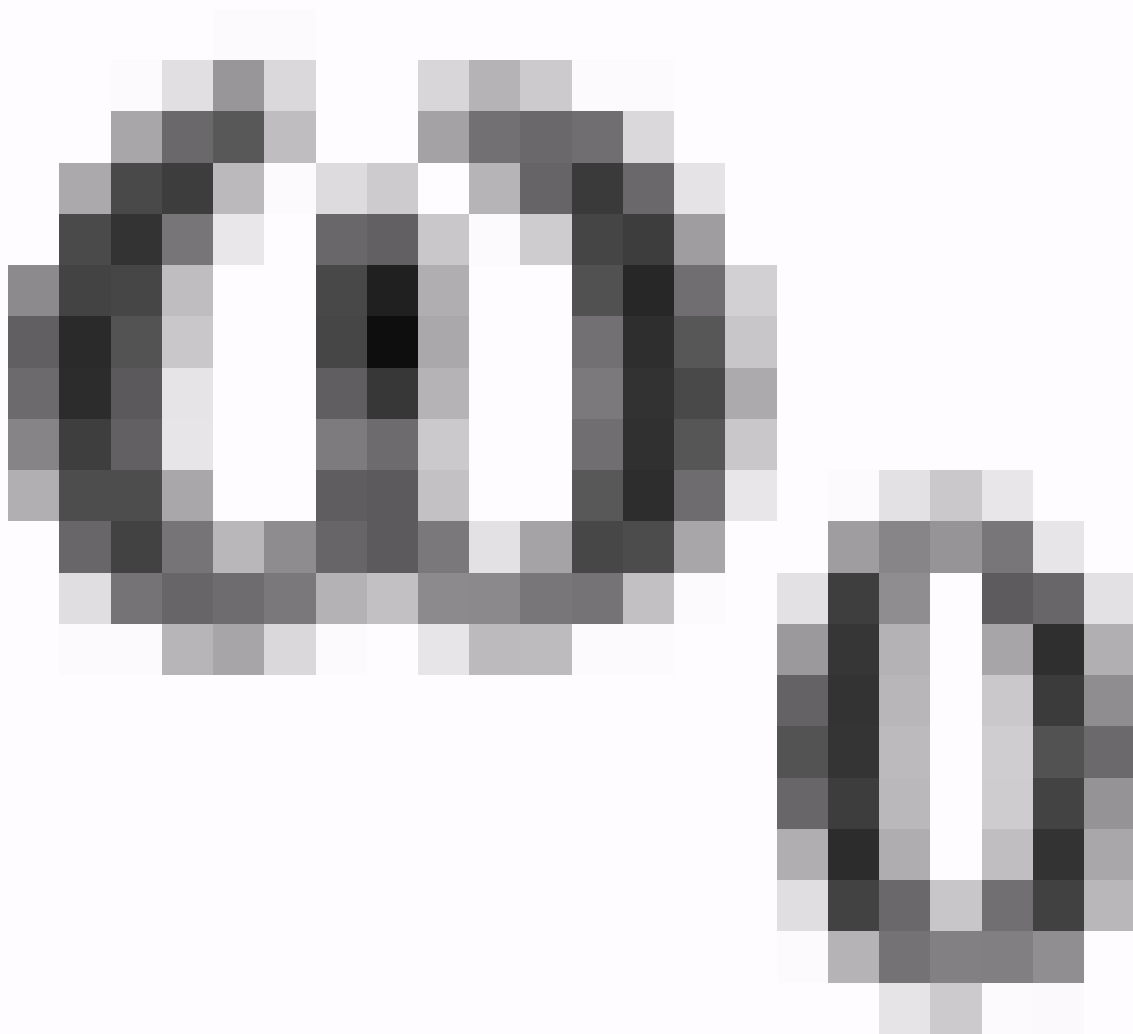

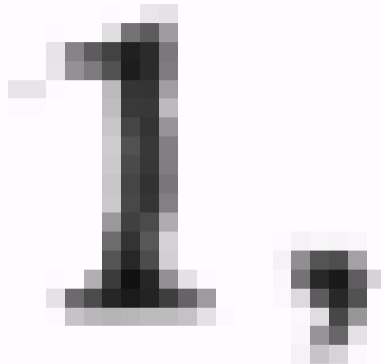
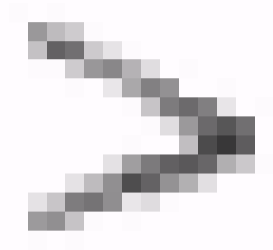
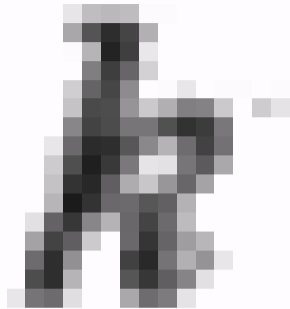

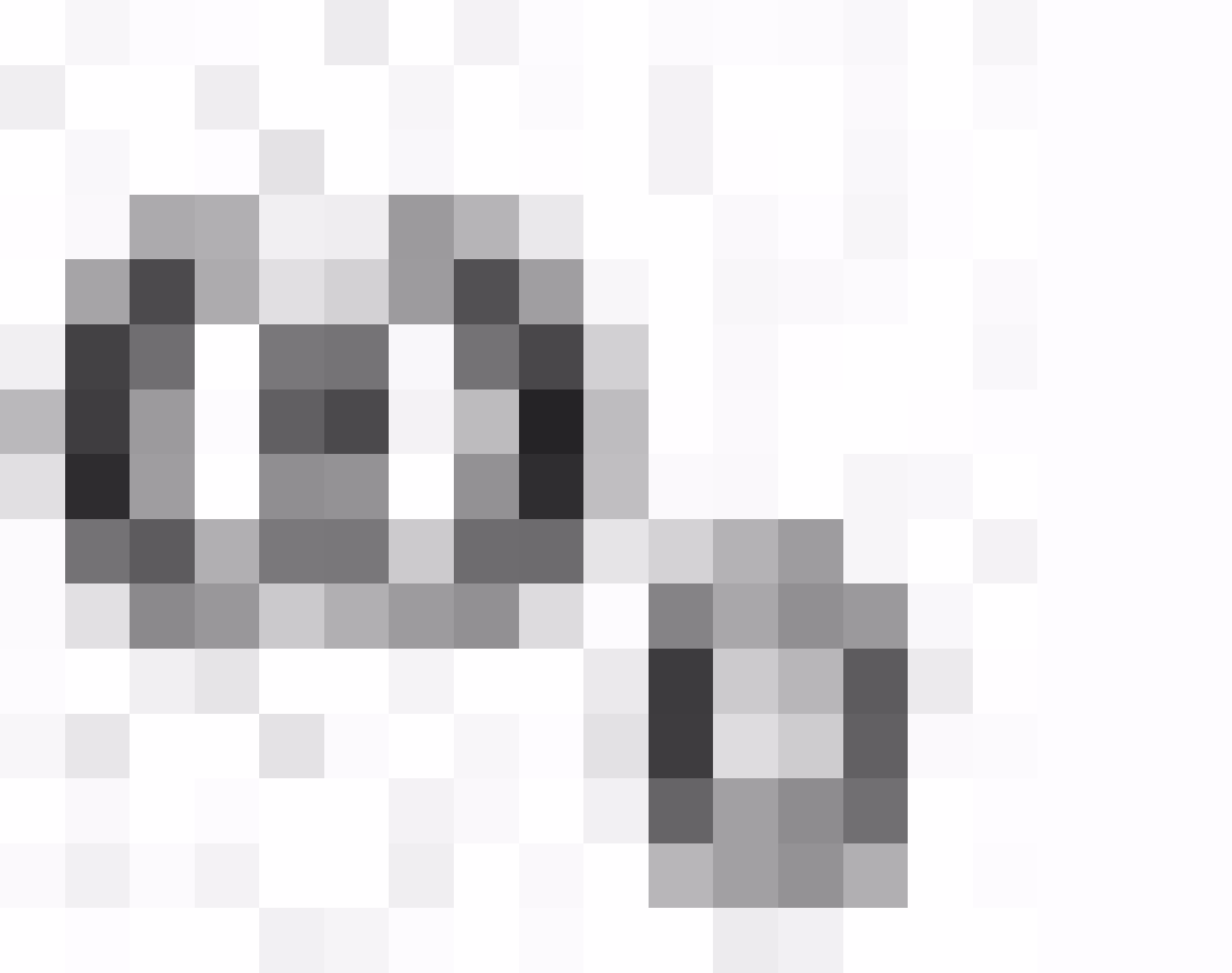

$$\omega_0 \mathcal{L} = \frac{1}{\omega_0 C} \quad (50.18)$$

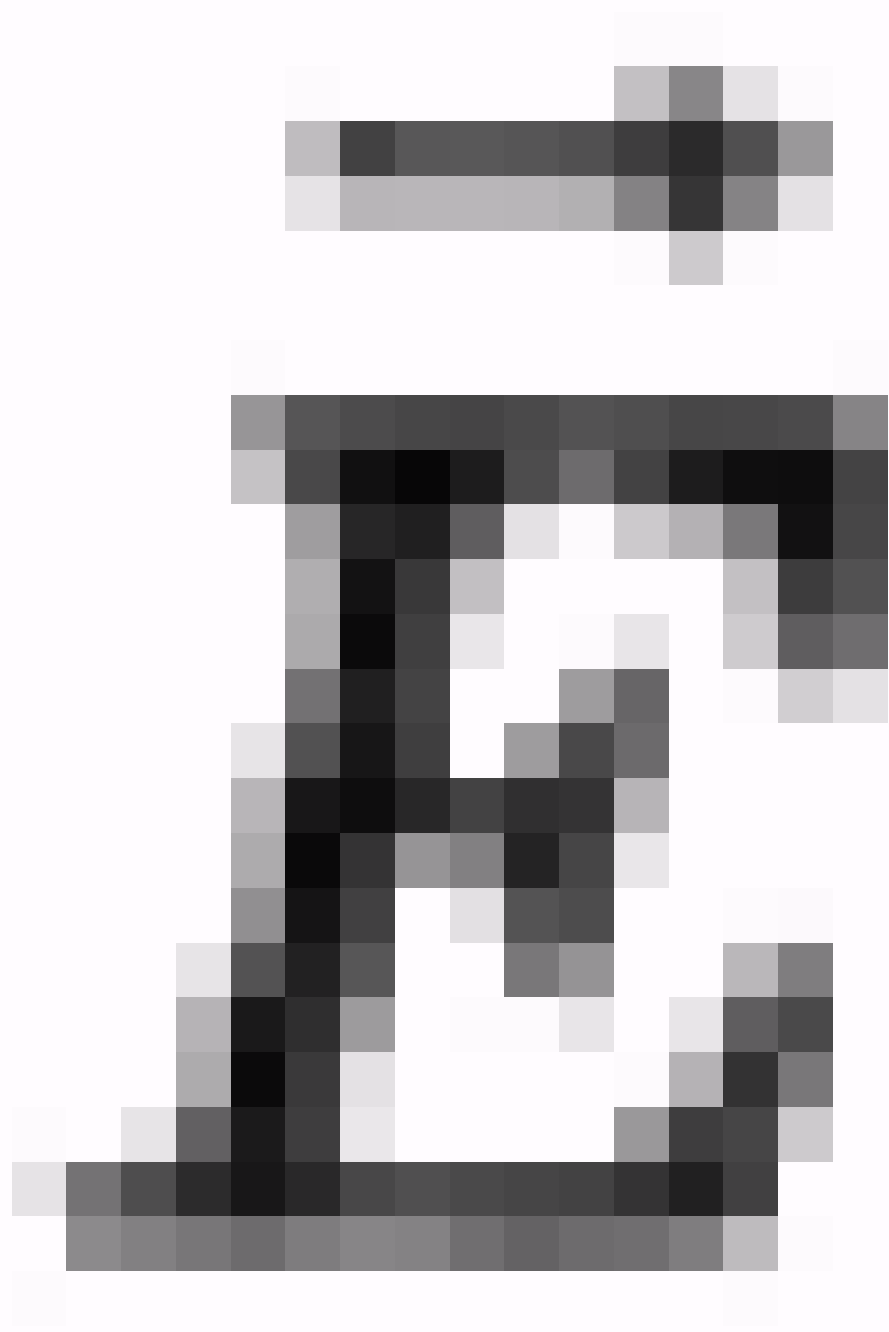



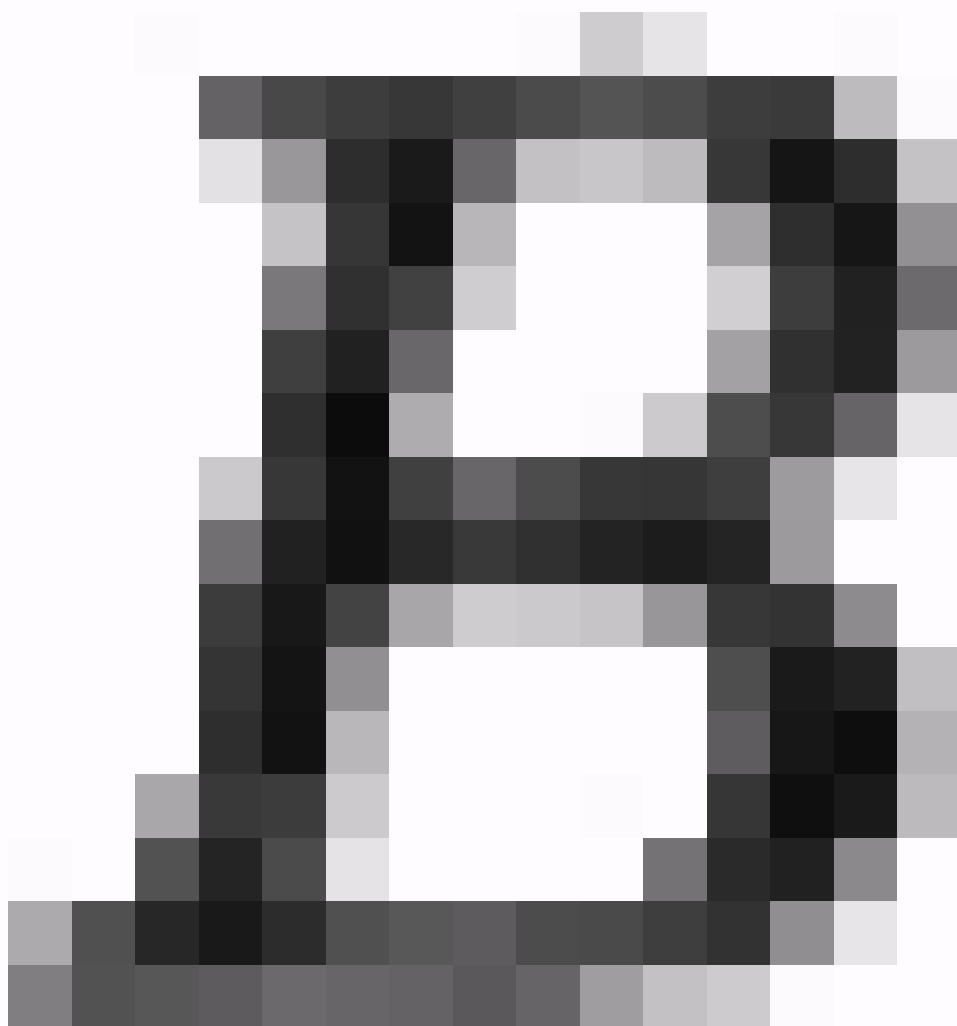
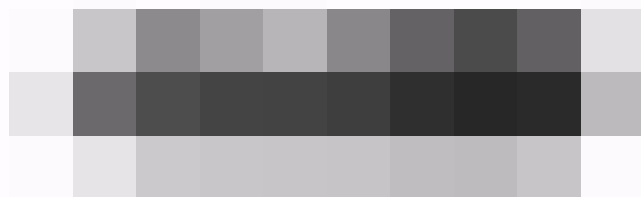

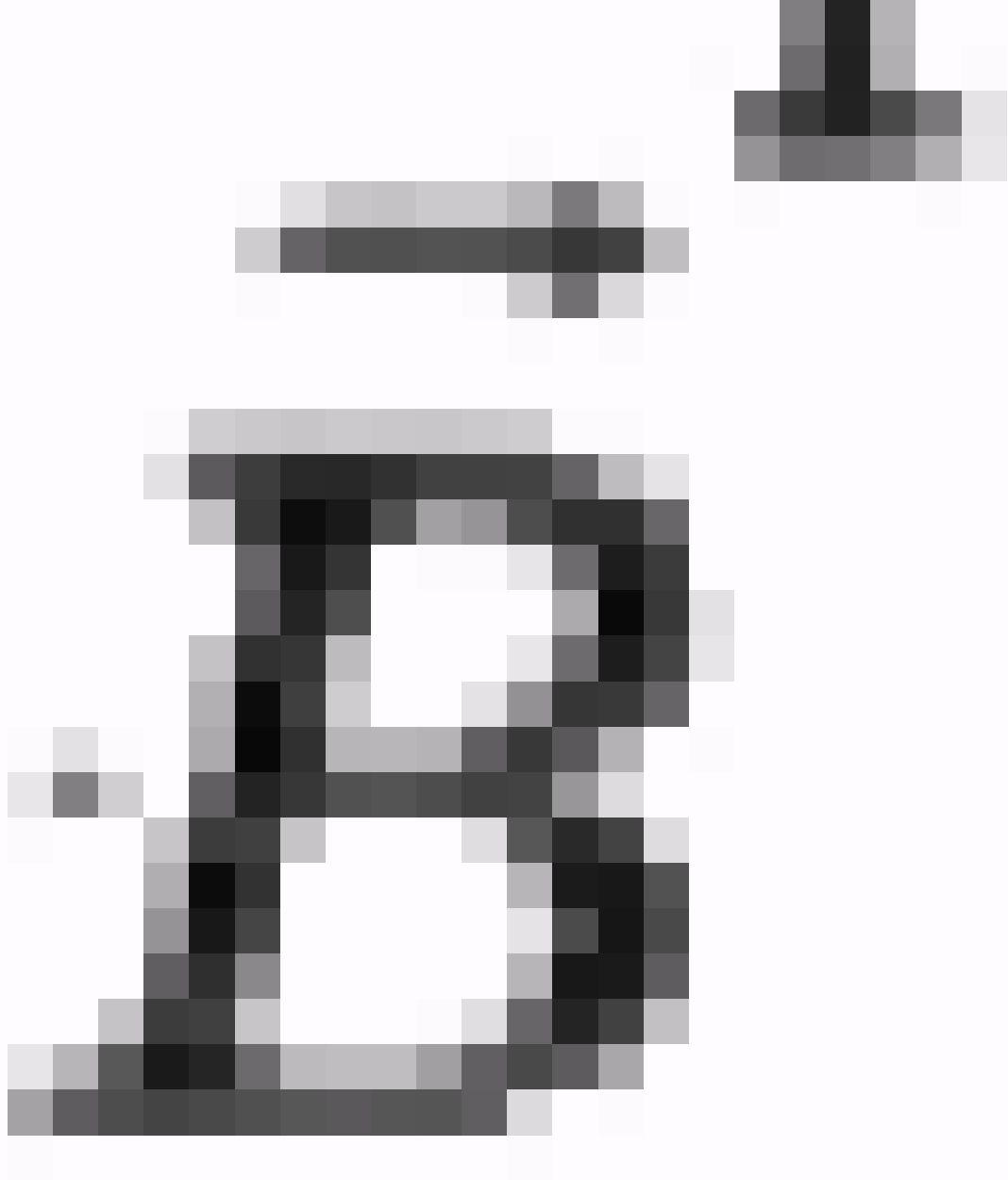

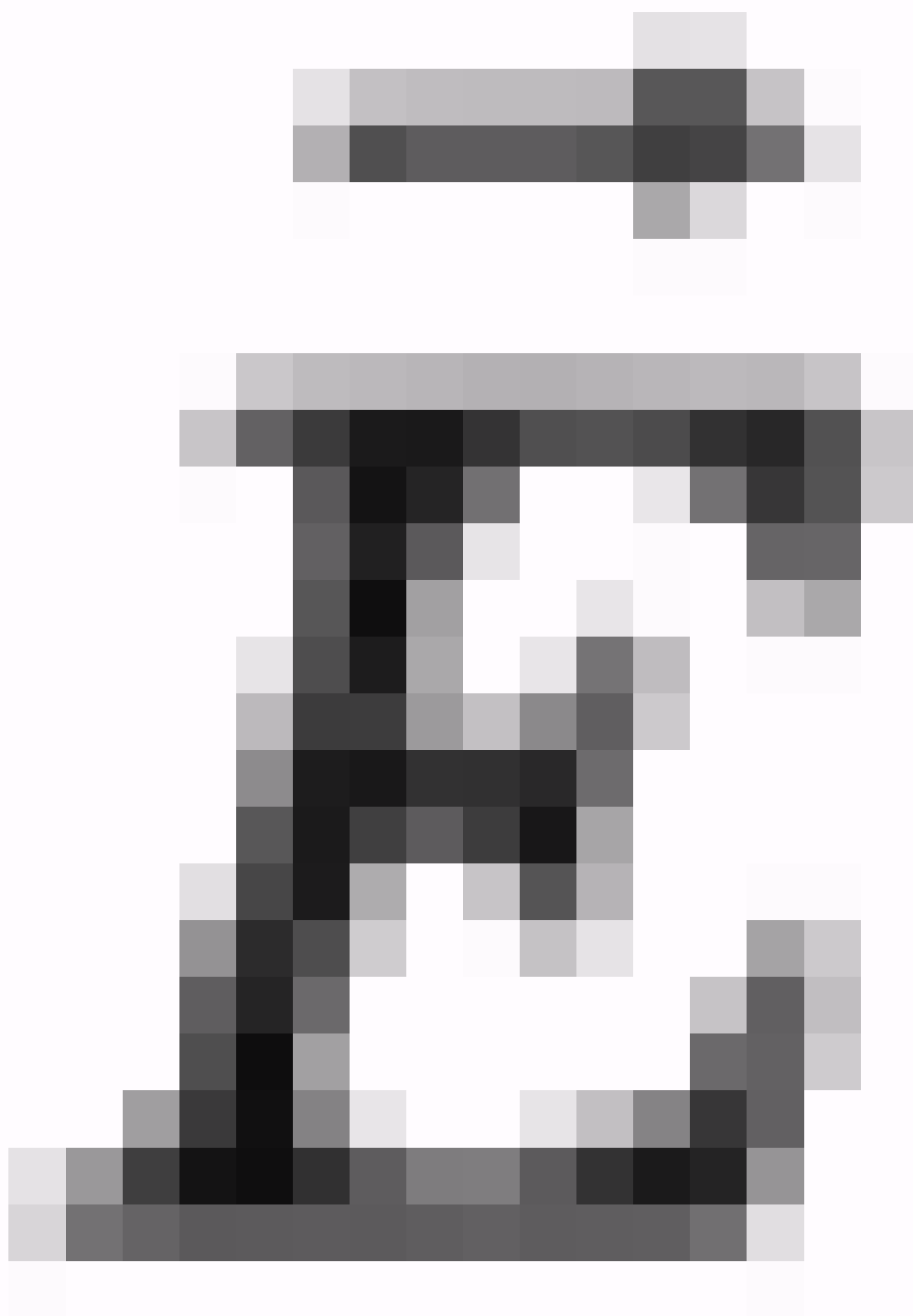

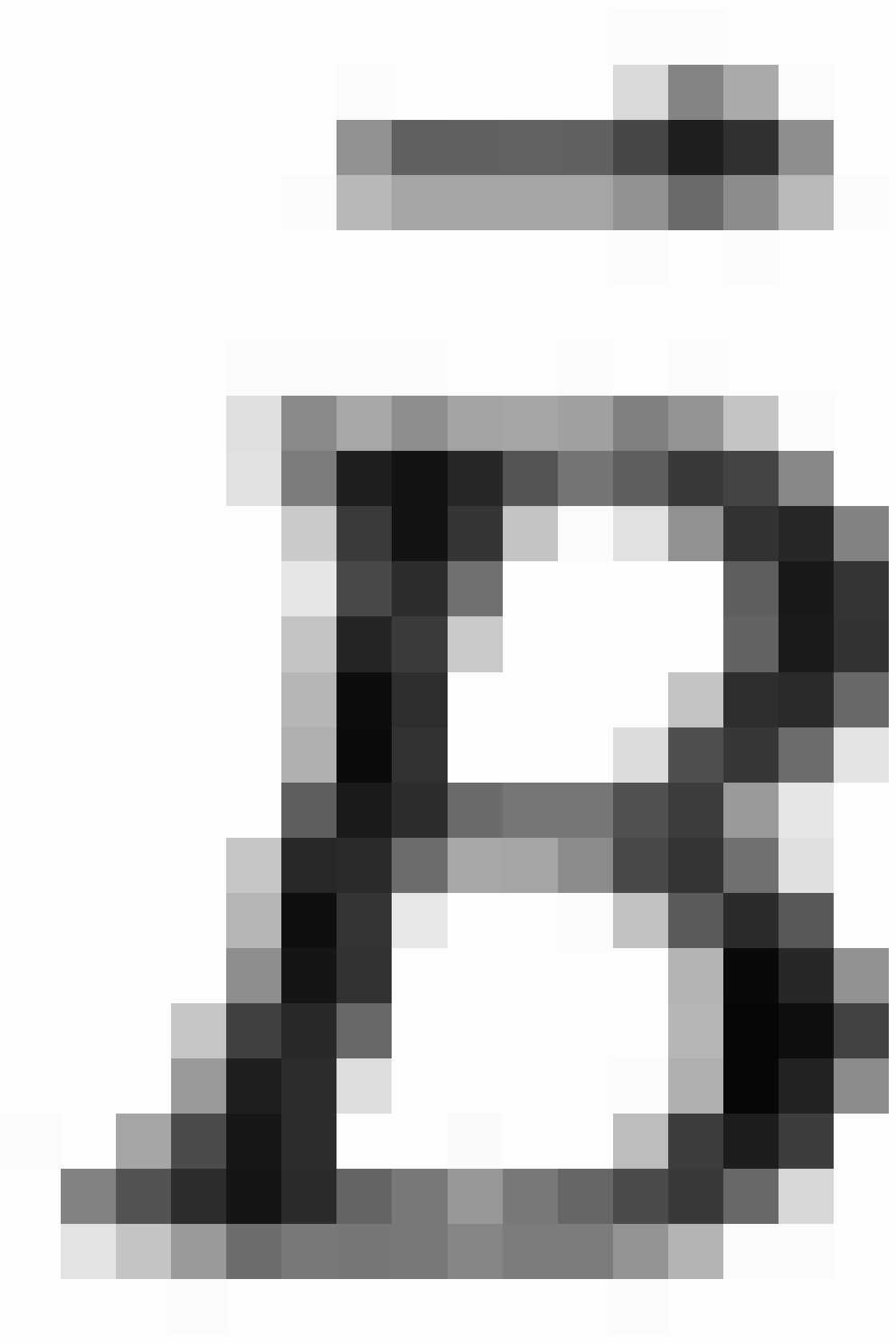

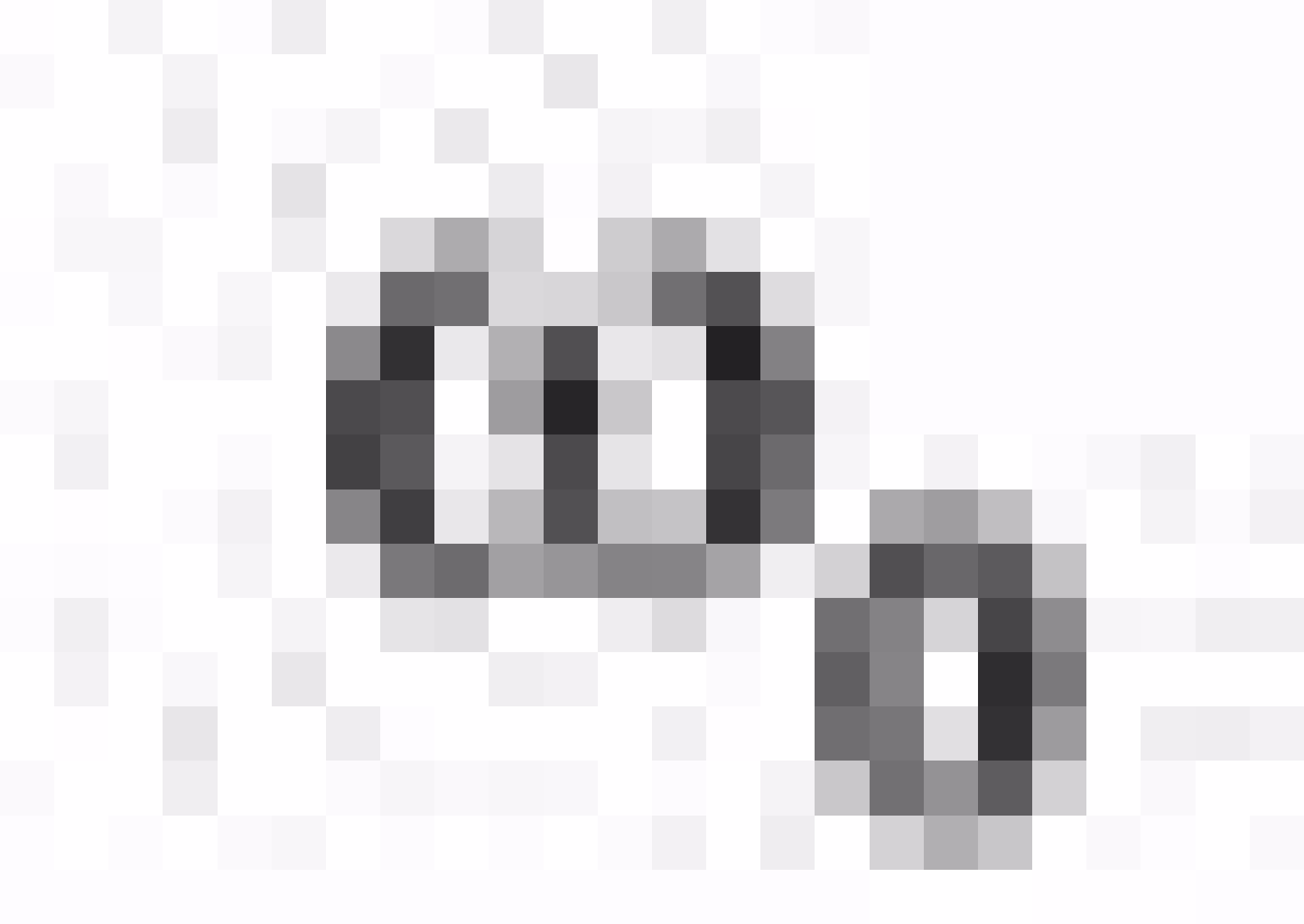

1991

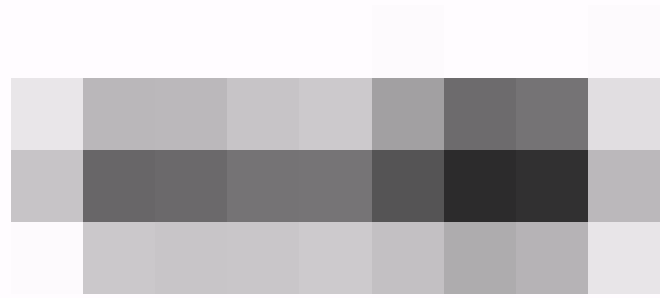
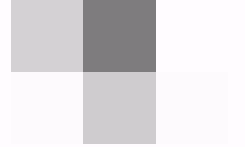

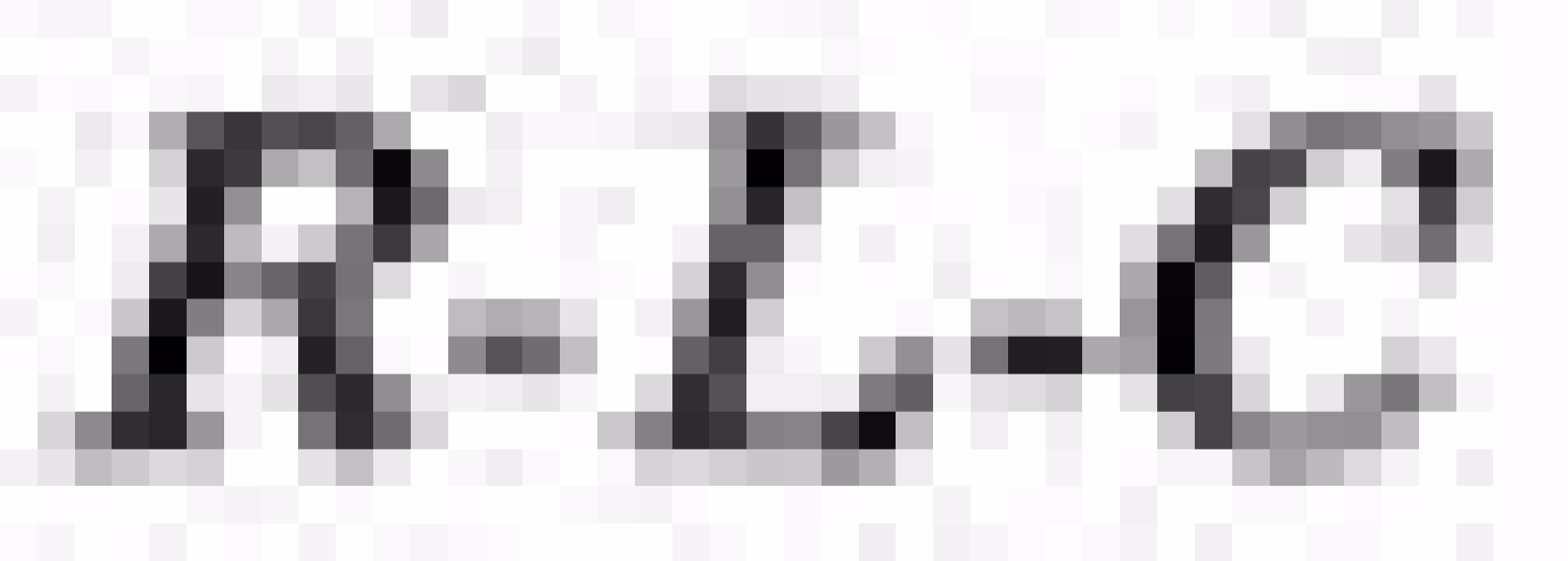

U C

=

U L

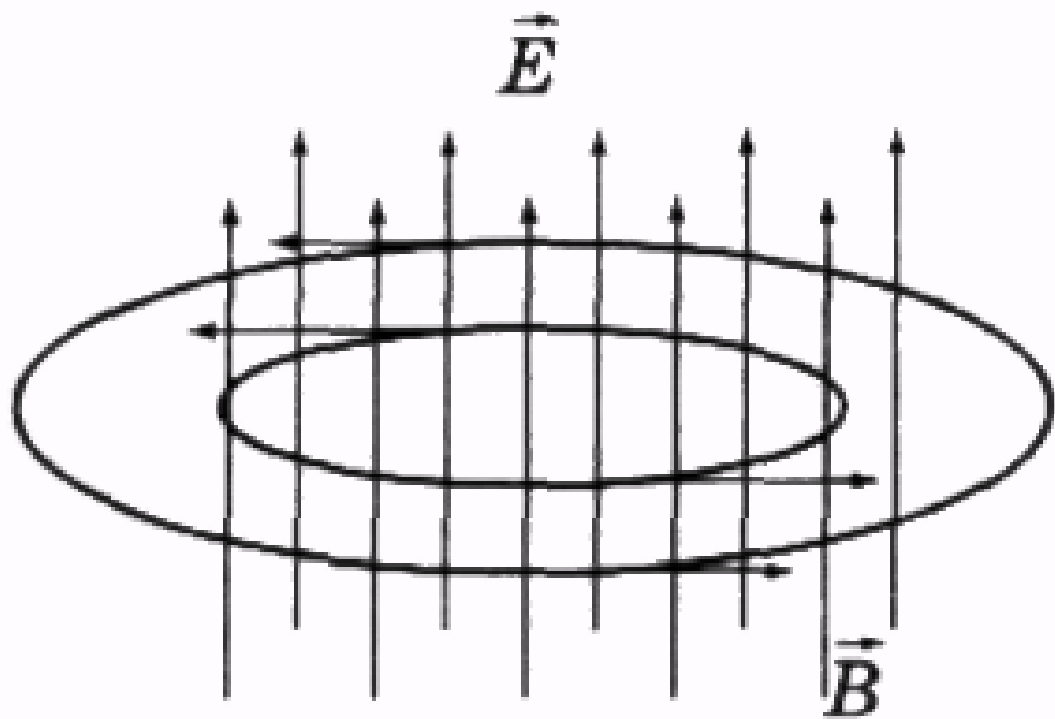

$$\frac{\Delta E}{\Delta t} > 0$$

WORLDWIDE

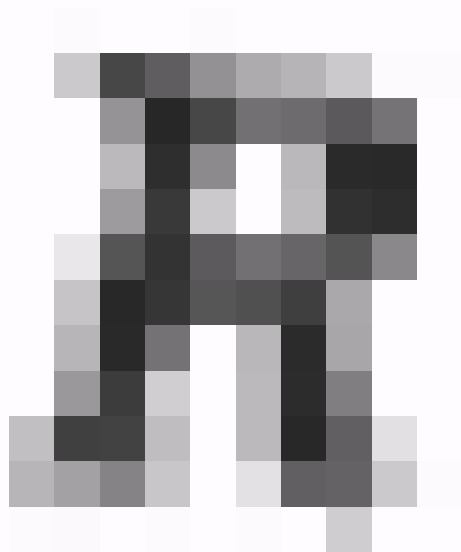
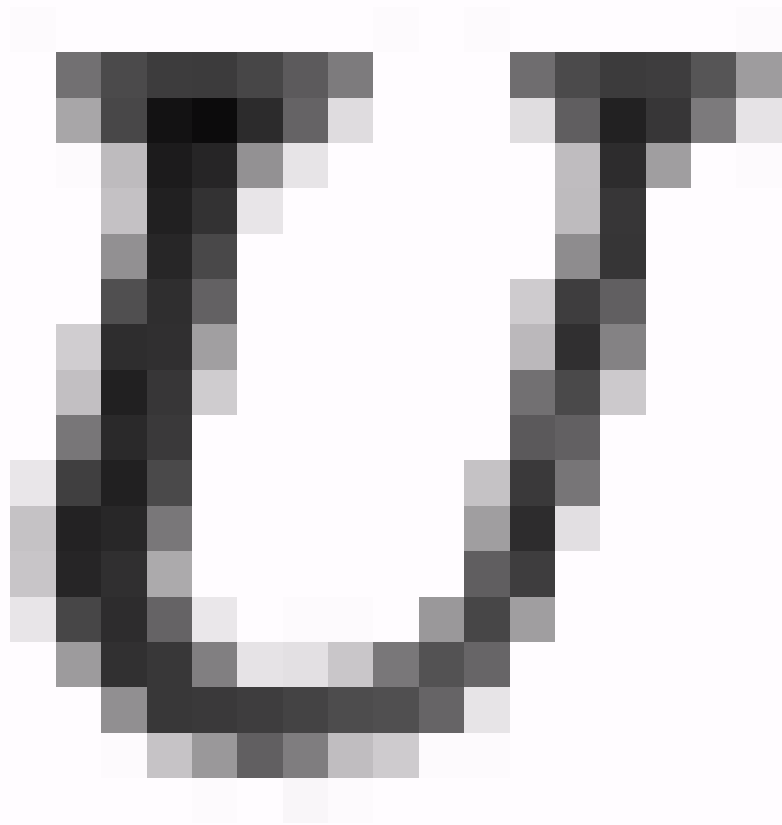

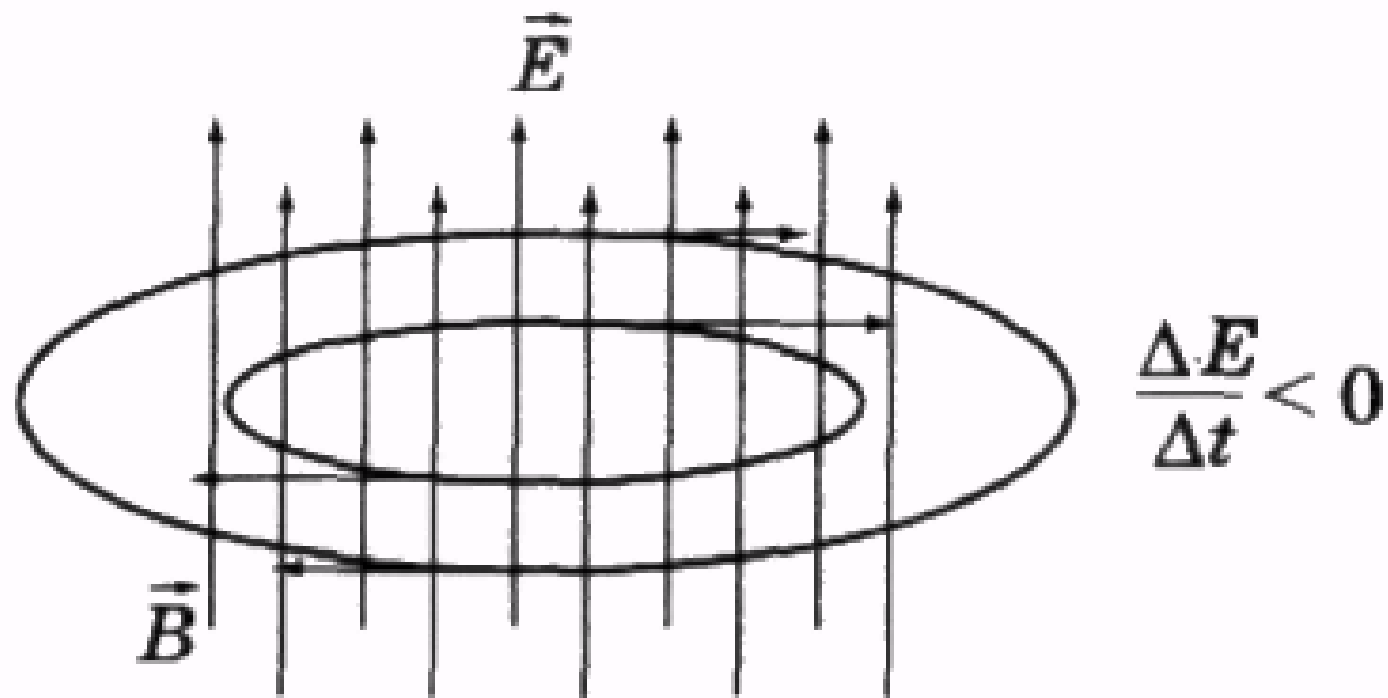

Мал. 2.168

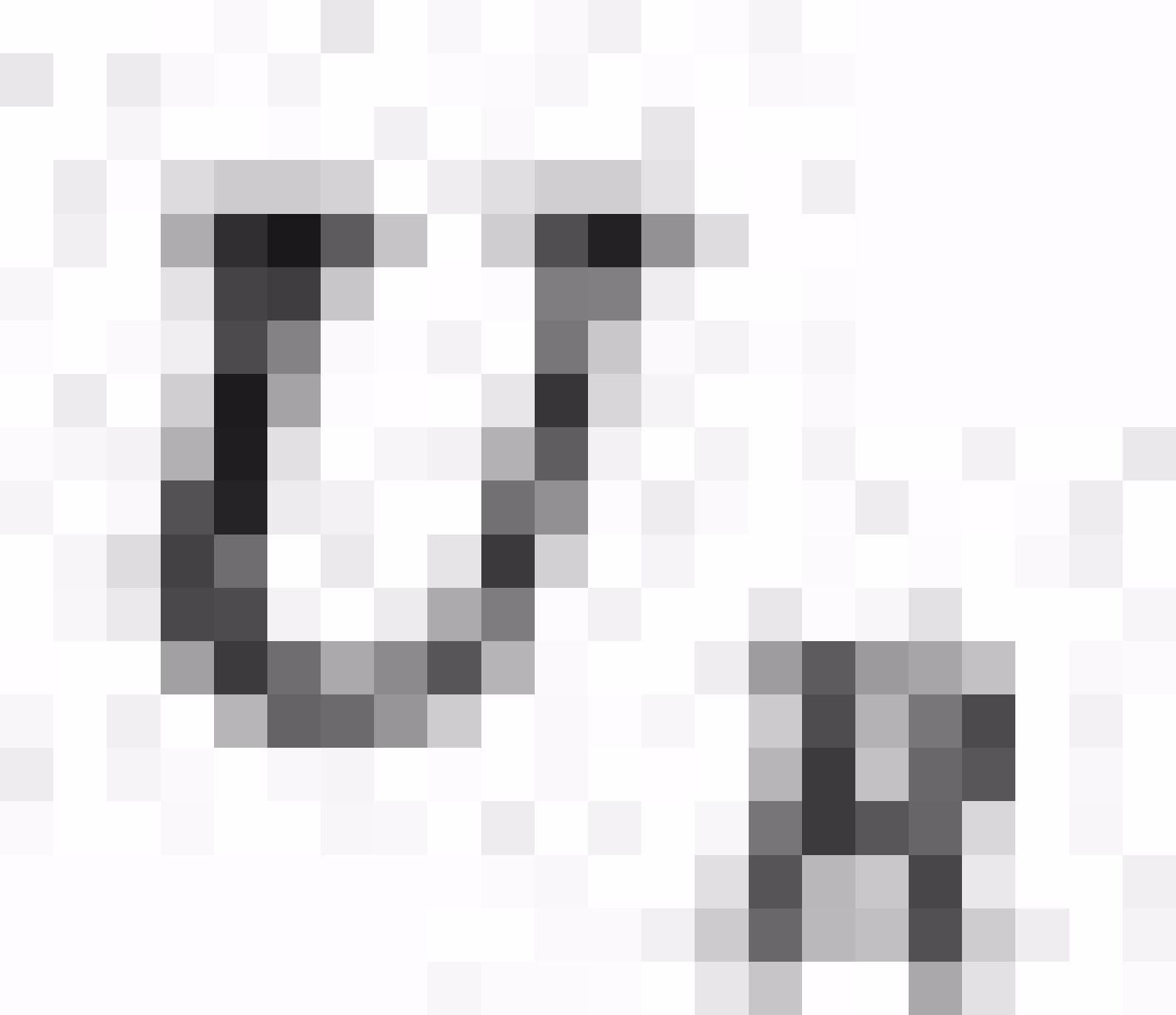

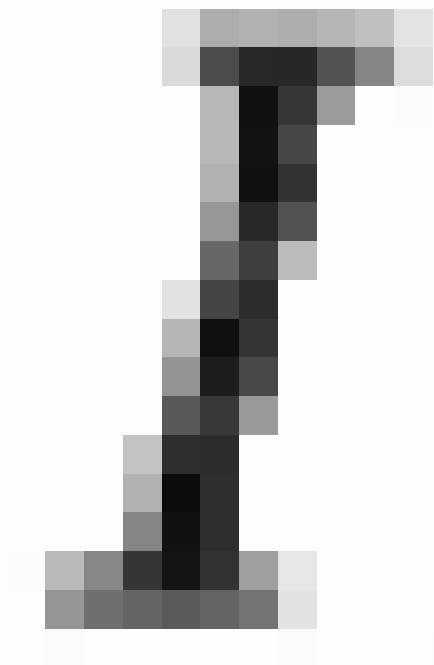

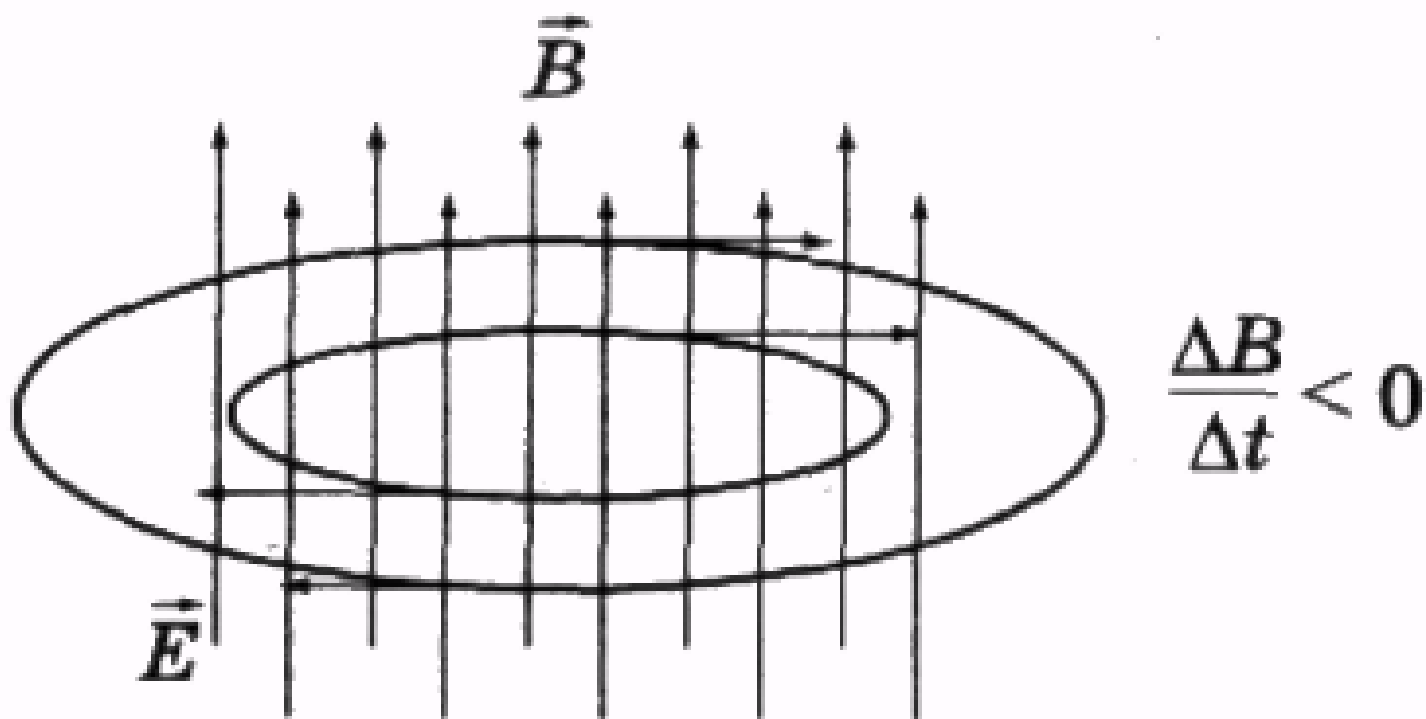
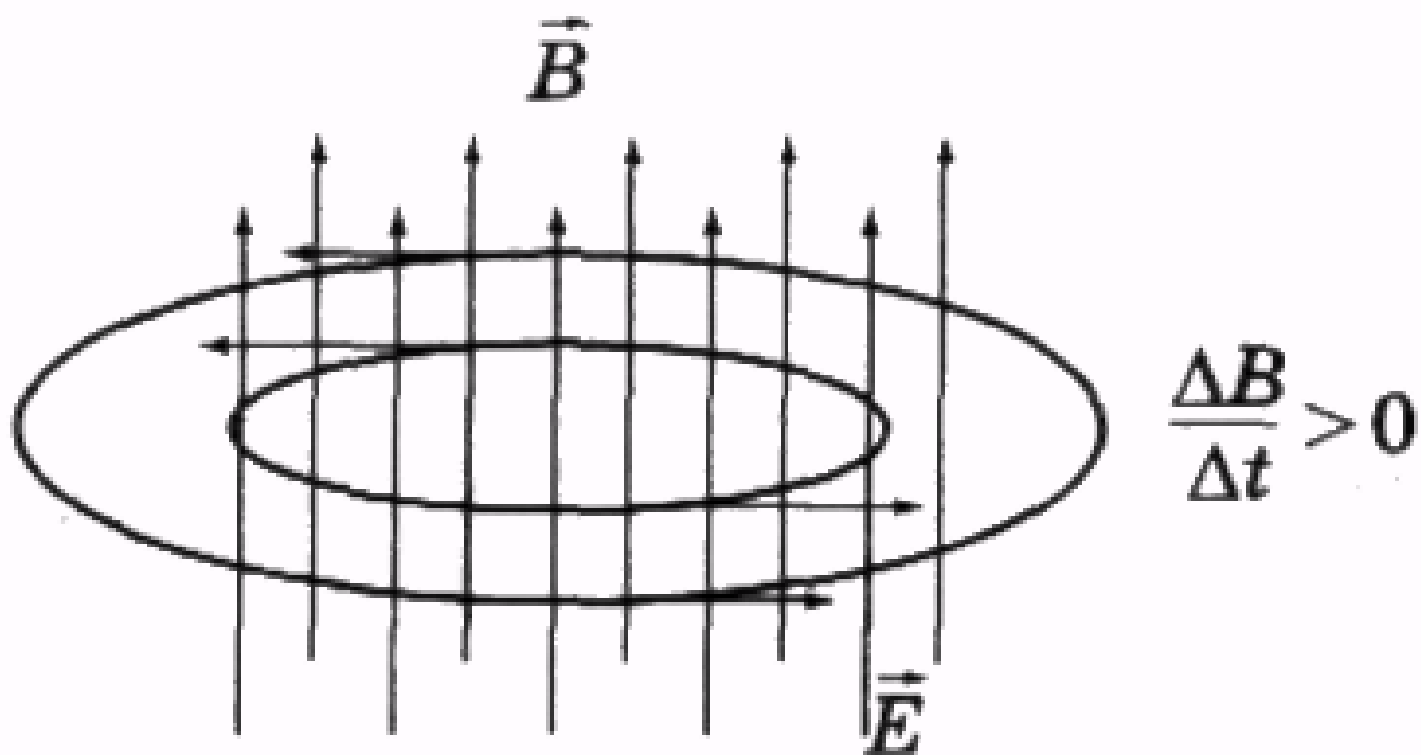

Мал. 2.169



$$\mathbb{I}_R = \frac{U}{R} = \frac{U}{R} \quad (50.20).$$

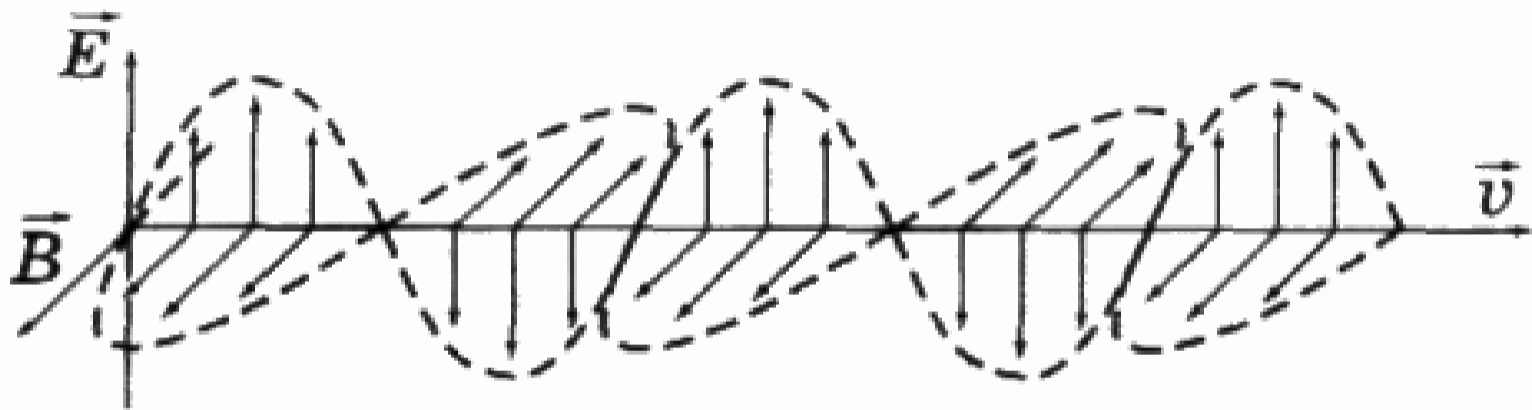

Мал. 2.170

1. U U
R R

100000

100

100

$$c = \frac{1}{\sqrt{\epsilon_0 \mu_0}} \approx 300\,000\,000 \text{ e i / s } \quad (52.1).$$

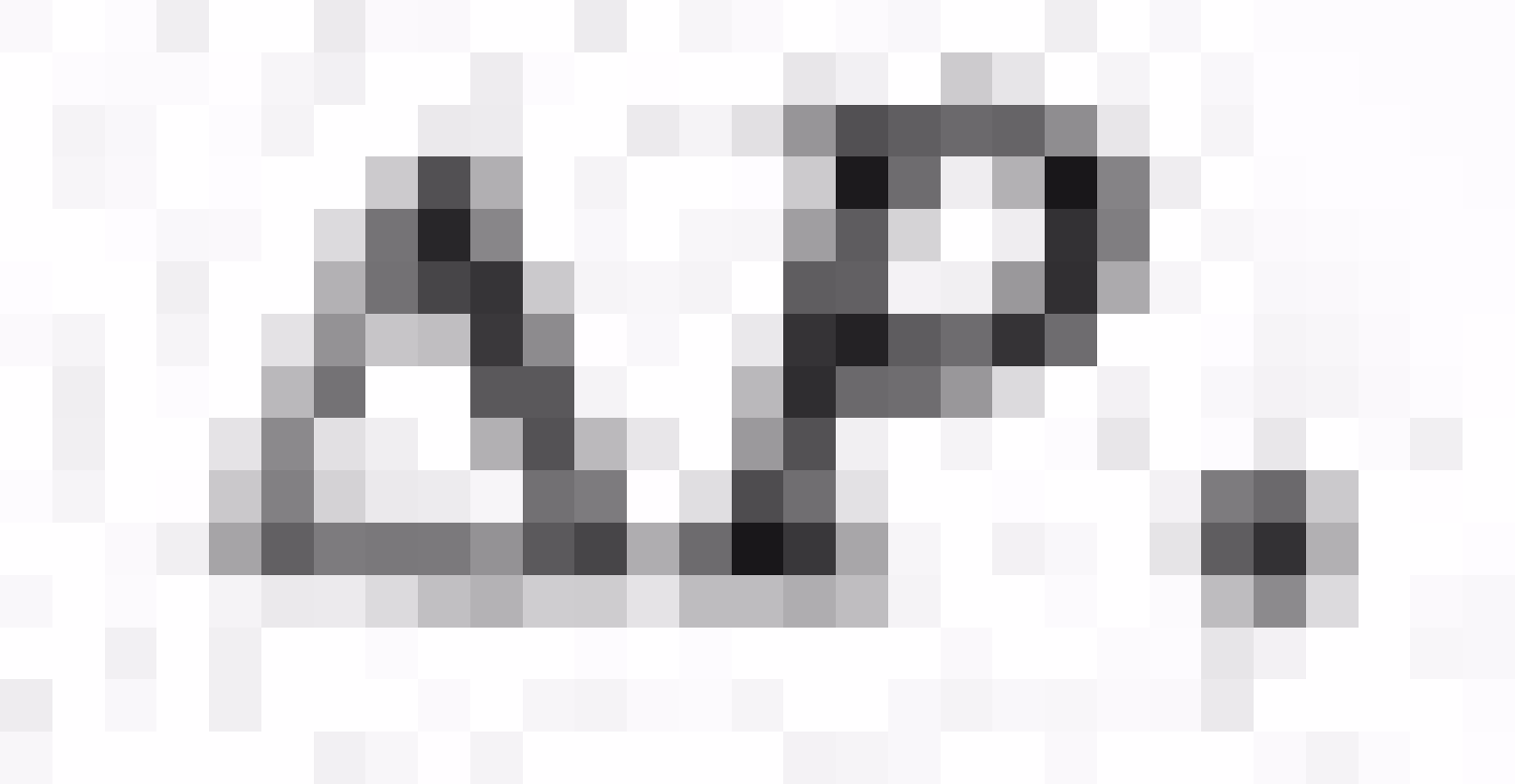

AP

=

IRP

(51.1)

$$v = \frac{1}{\sqrt{\epsilon\epsilon_0\mu\mu_0}} \quad (52.2)$$

WORLD

WORLD

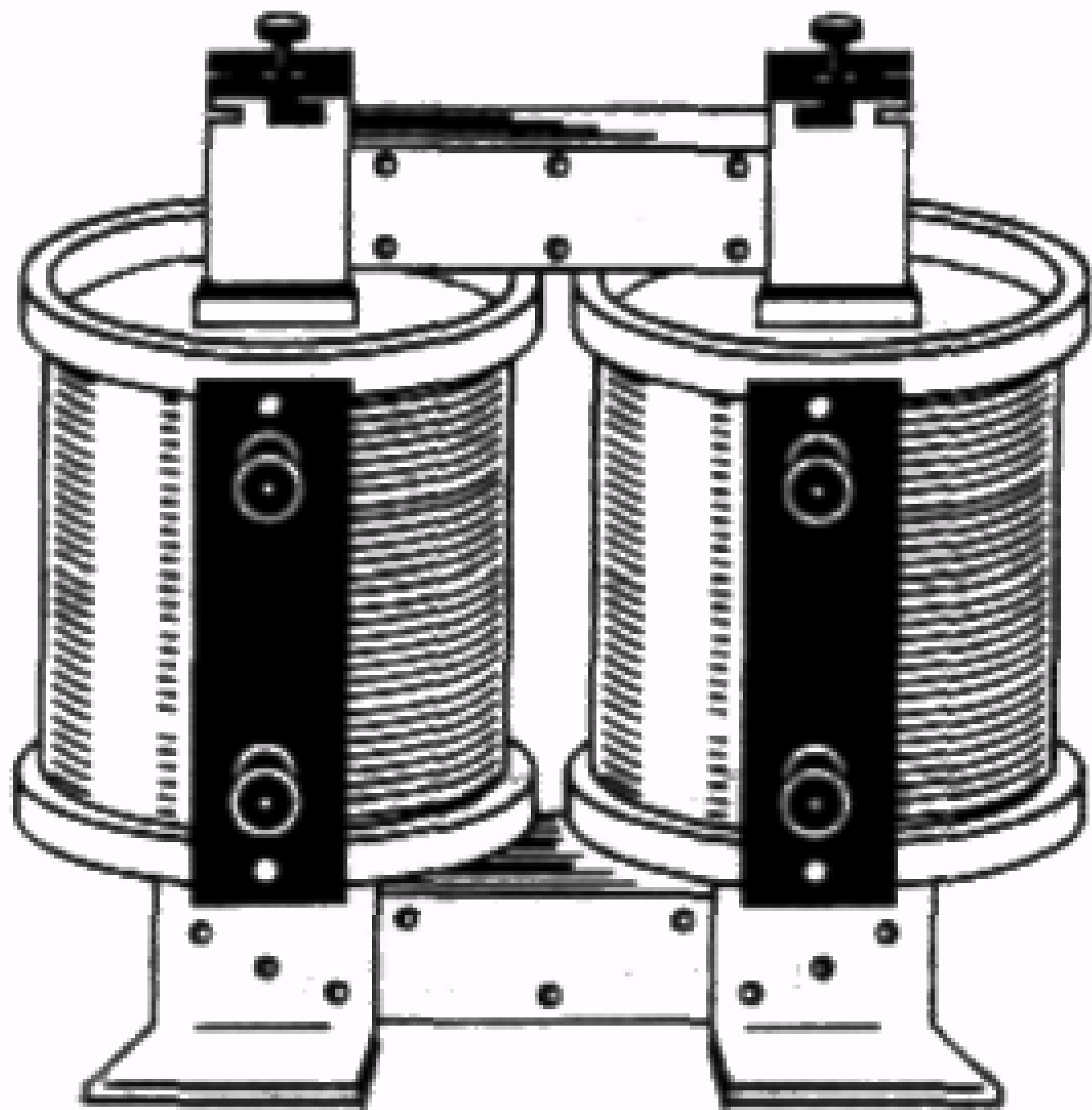

Мал. 2.167

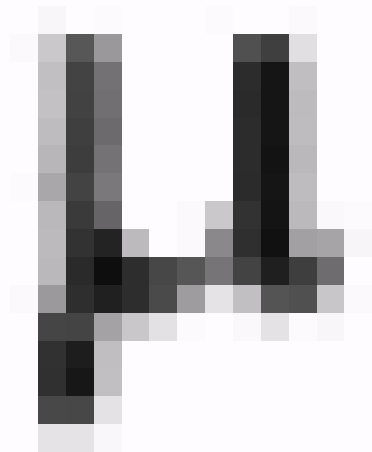
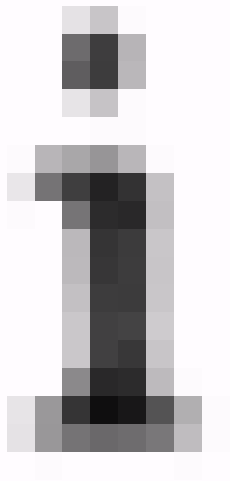
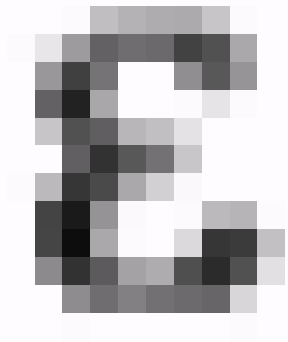

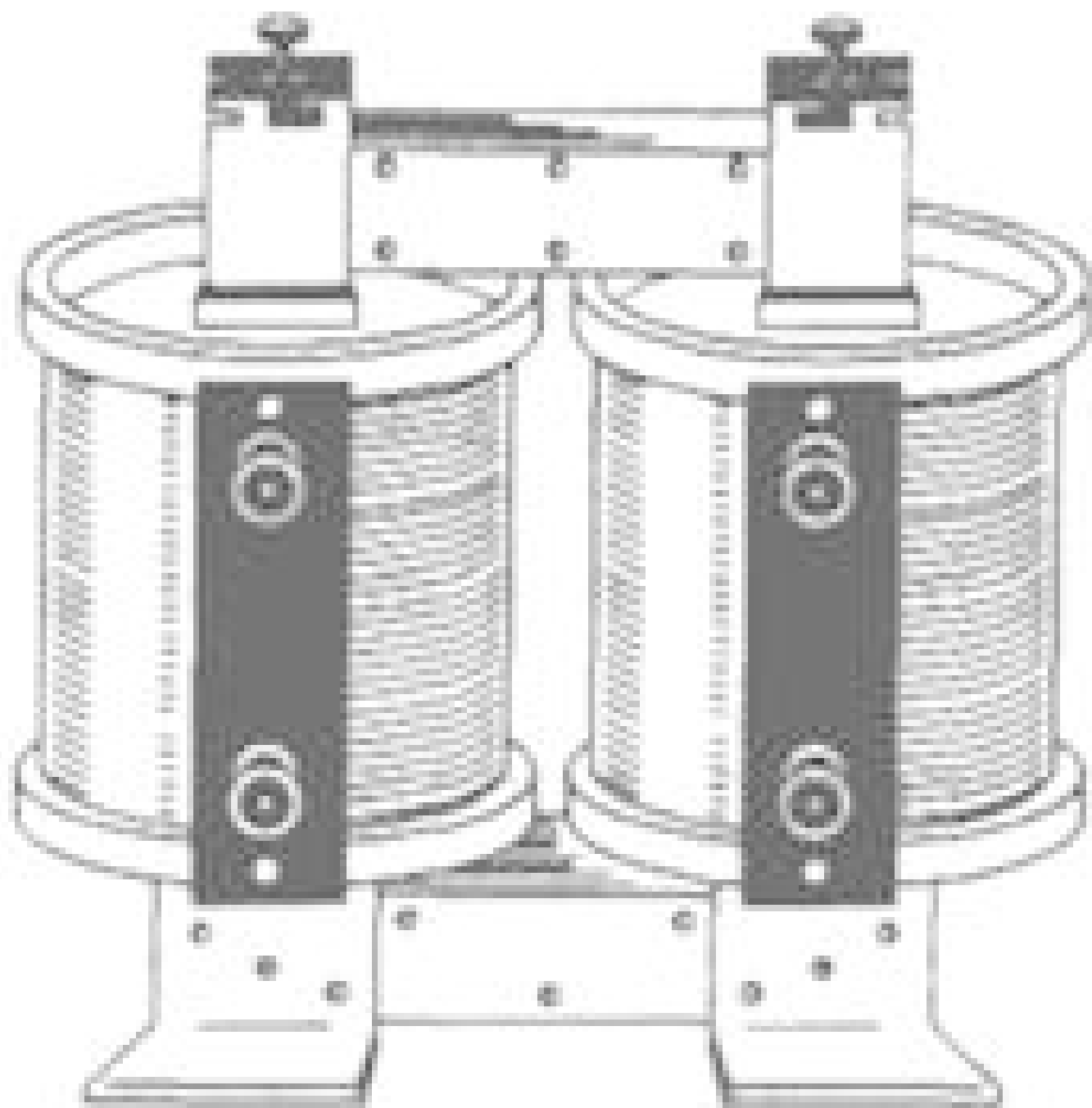

Мал. 2.167

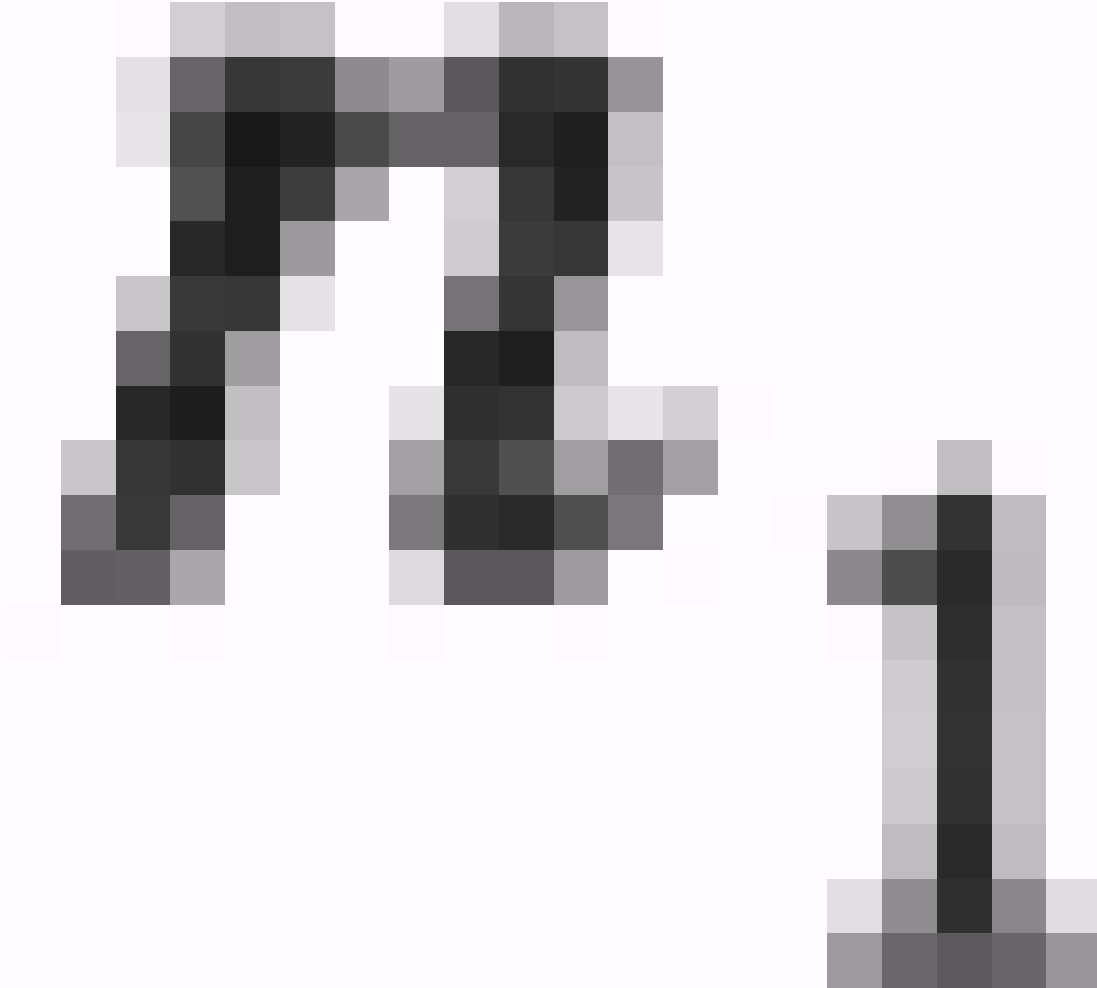

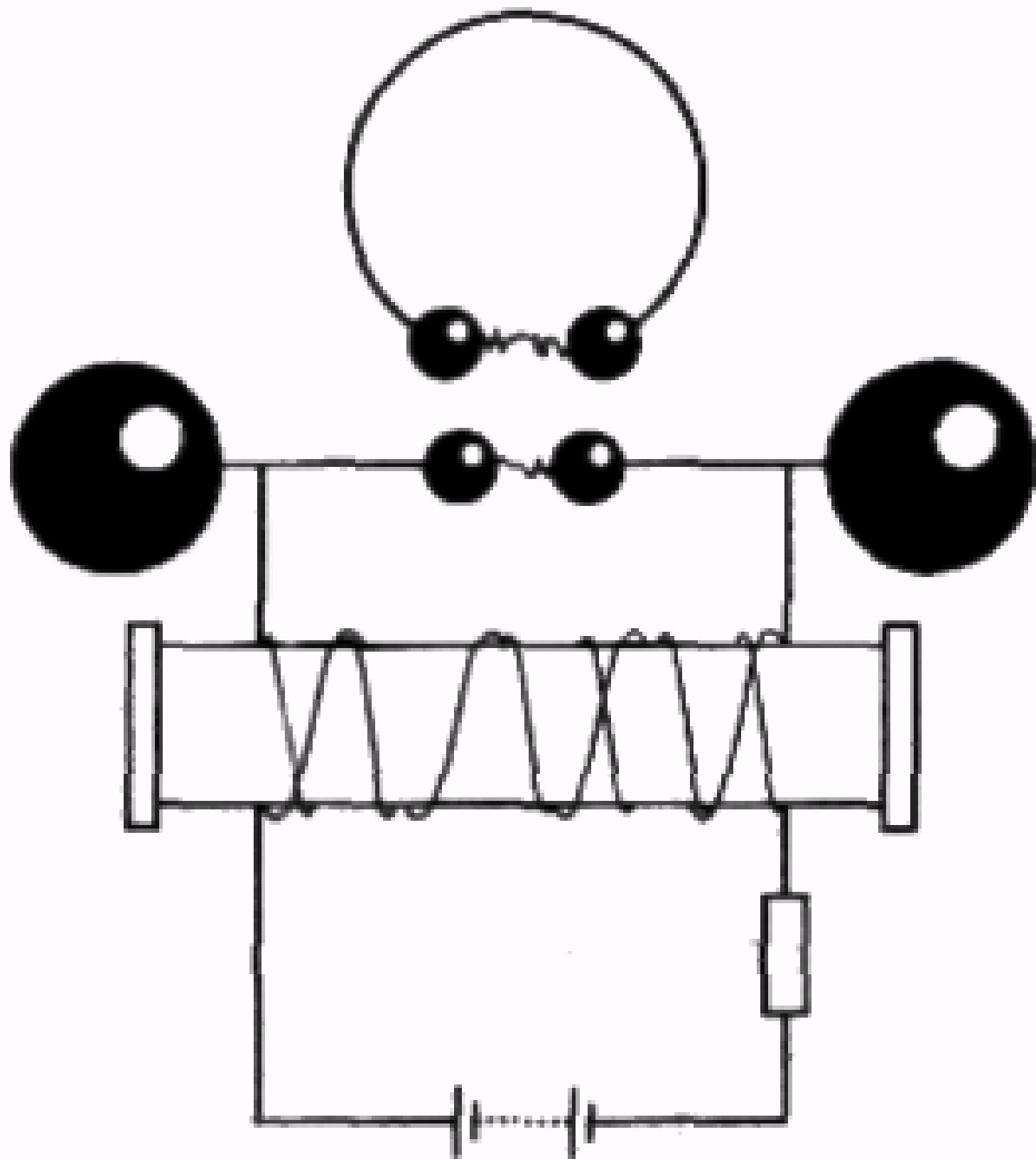

Мал. 2.171

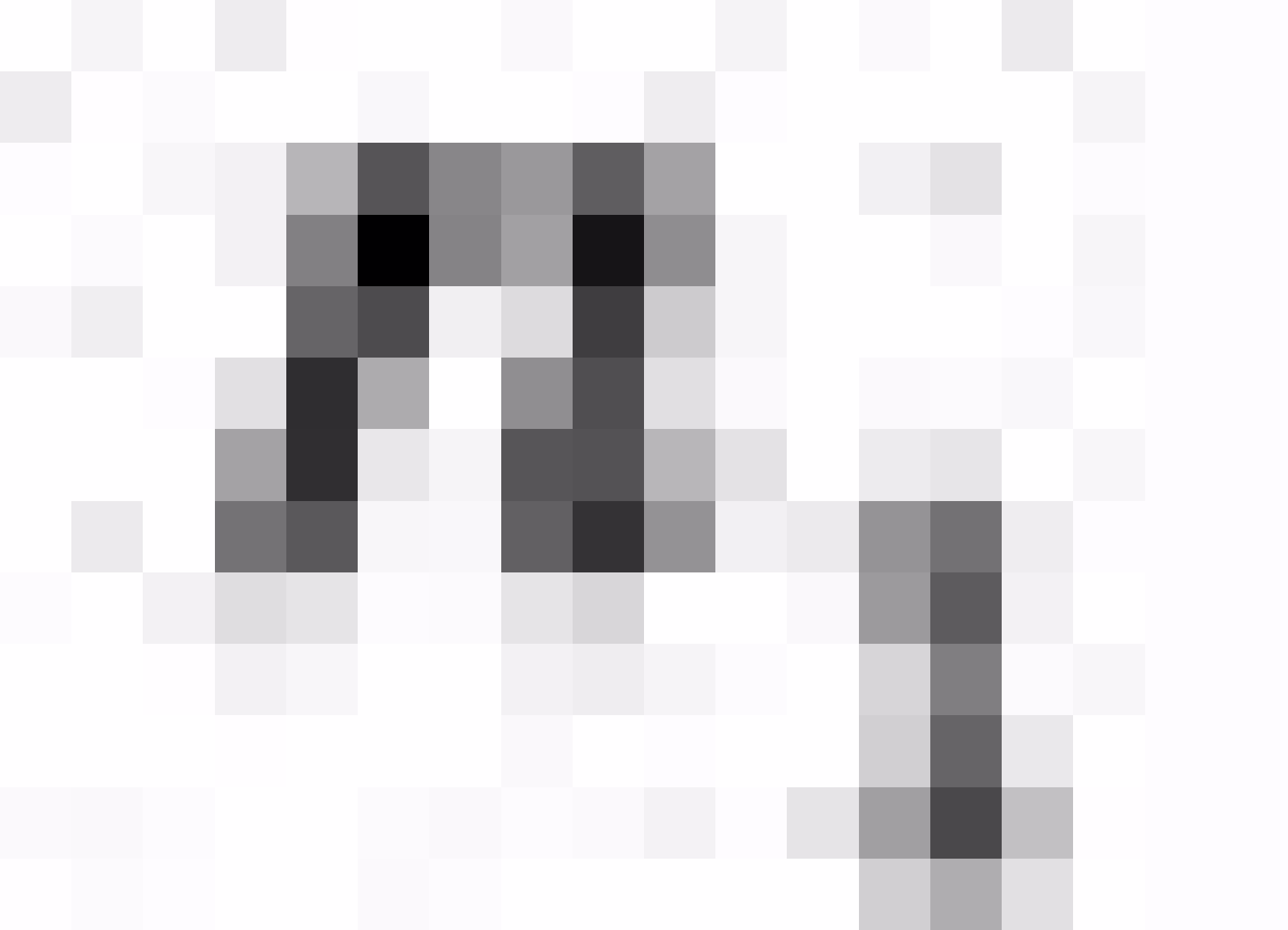

er

—

erri

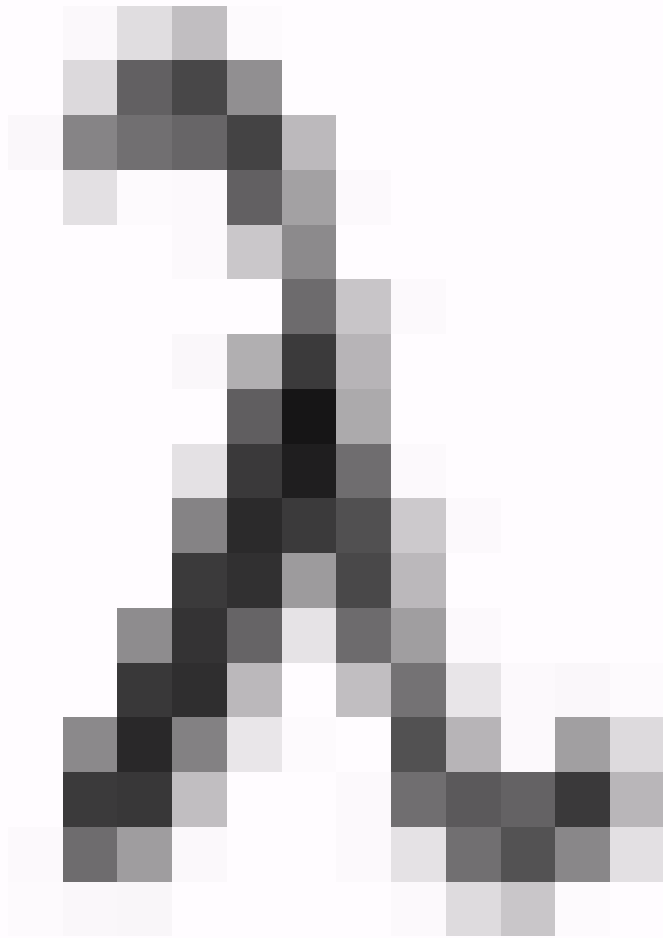



u

=

2

v

$$\frac{e_1}{\hbar} = \frac{n_1}{\hbar}$$

$$e_2 = n_2$$

(51.2)

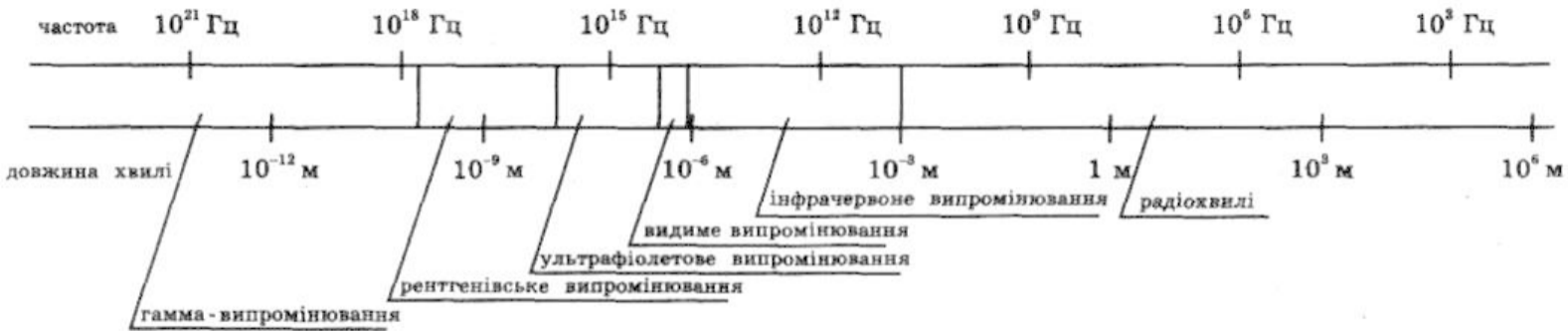

Мал. 2.172

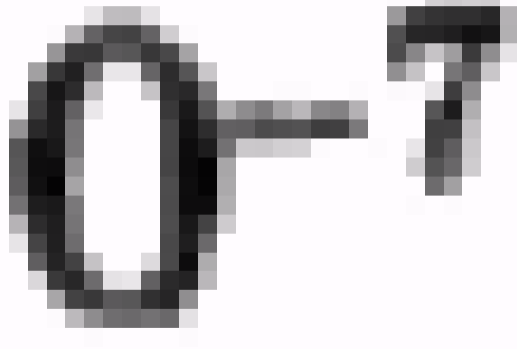
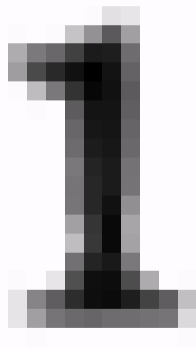
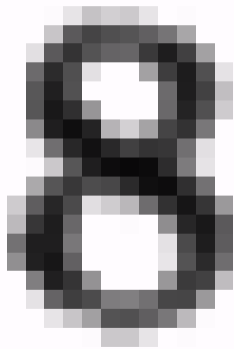

9

.

107

10

107

.

107

107

.

4

.

1

0

—

7

10

0

1

.

1

0

—

1

11

.

1000

1000

1000

1000

1010 1110

10-10

10

10-10

10

$$\Phi = \frac{E}{t}$$

(52.3).

$$\varphi = \frac{\Phi}{S}$$

(52.4)

$$\varphi = \frac{\Phi}{S} = \frac{\Phi}{4\pi R^2} = \frac{E}{4\pi R^2 t} \quad (52.5)$$

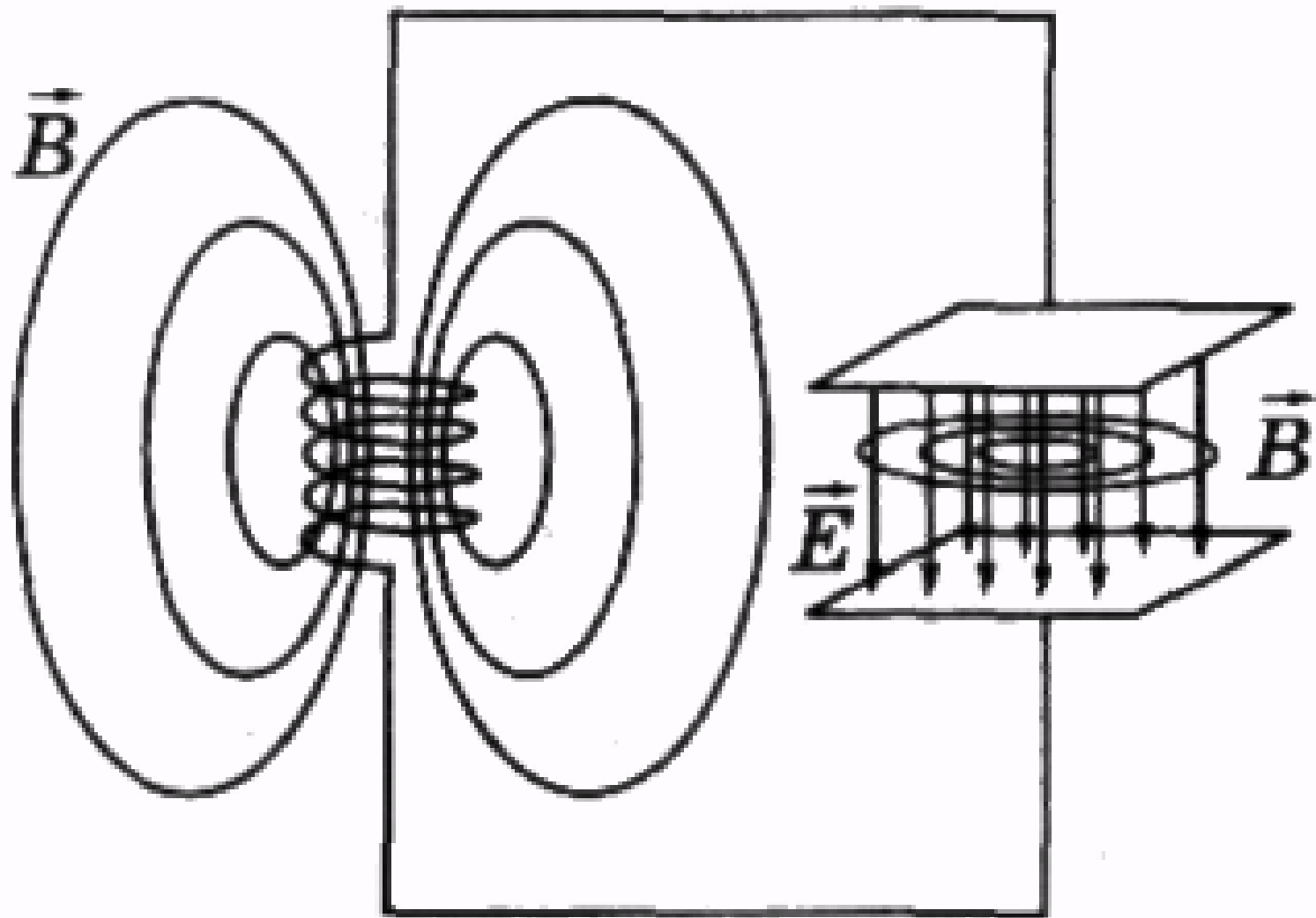

Мал. 2.173

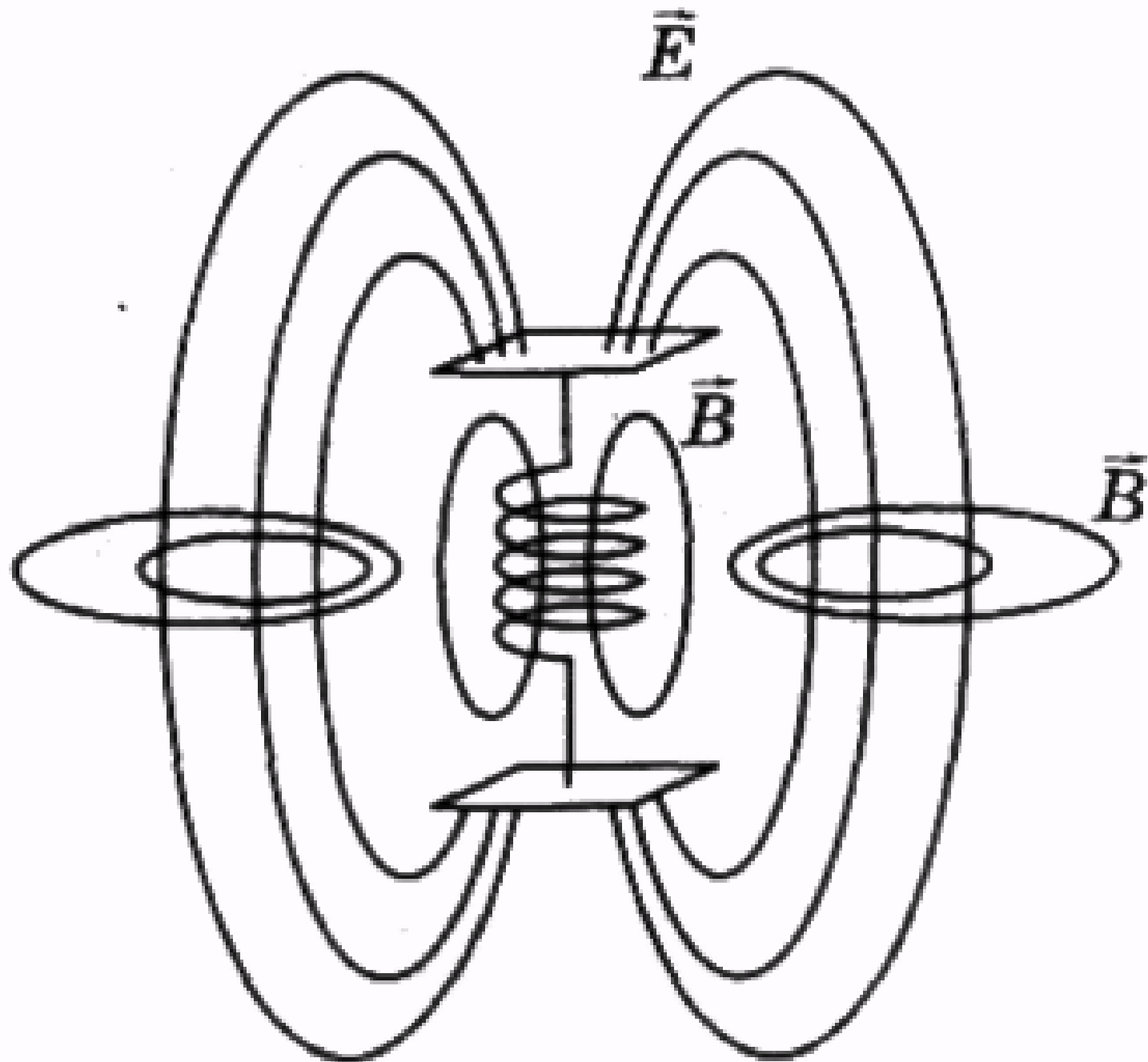

Мал. 2.174

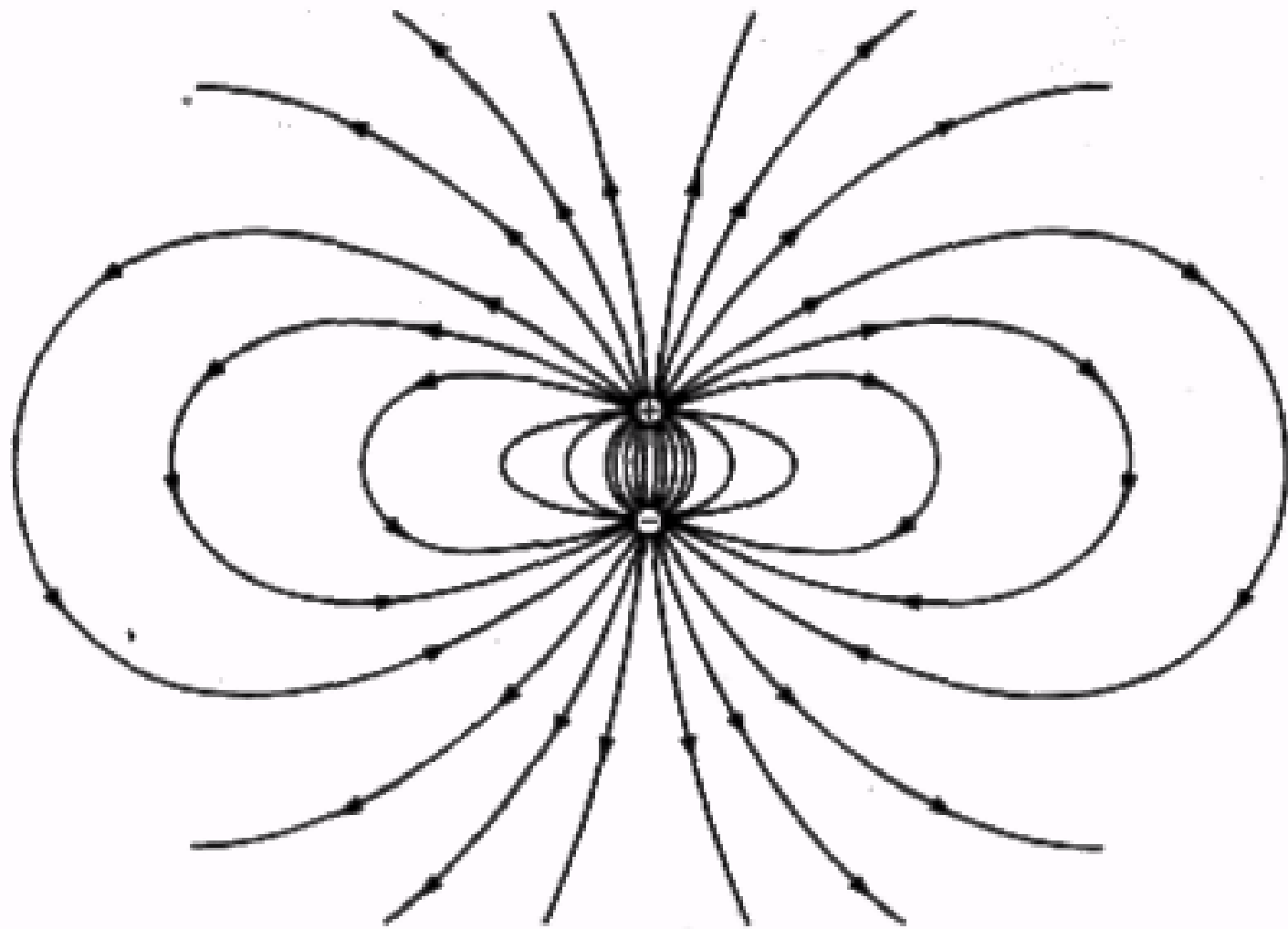

Мал. 2.175

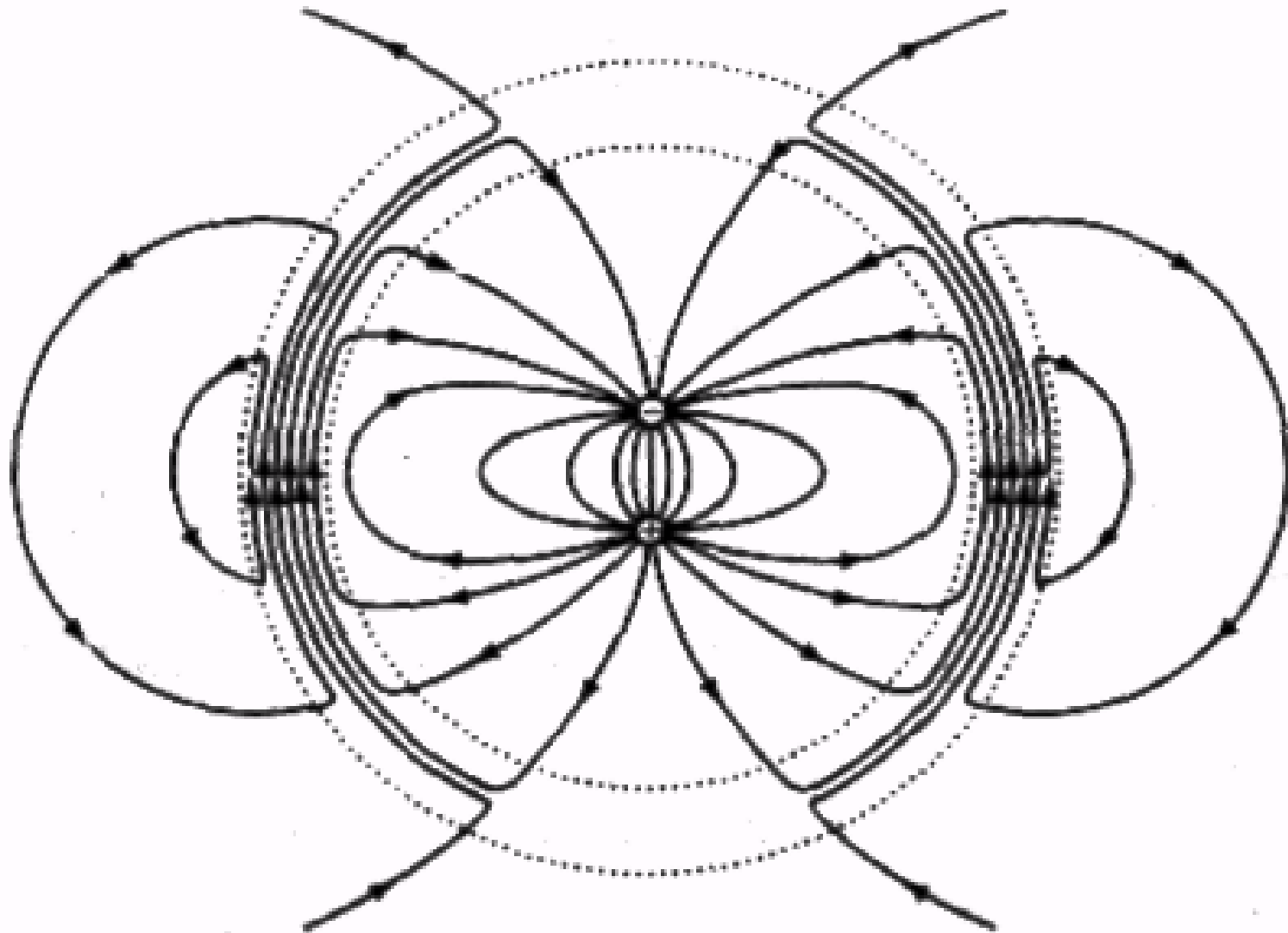

Мал. 2.176

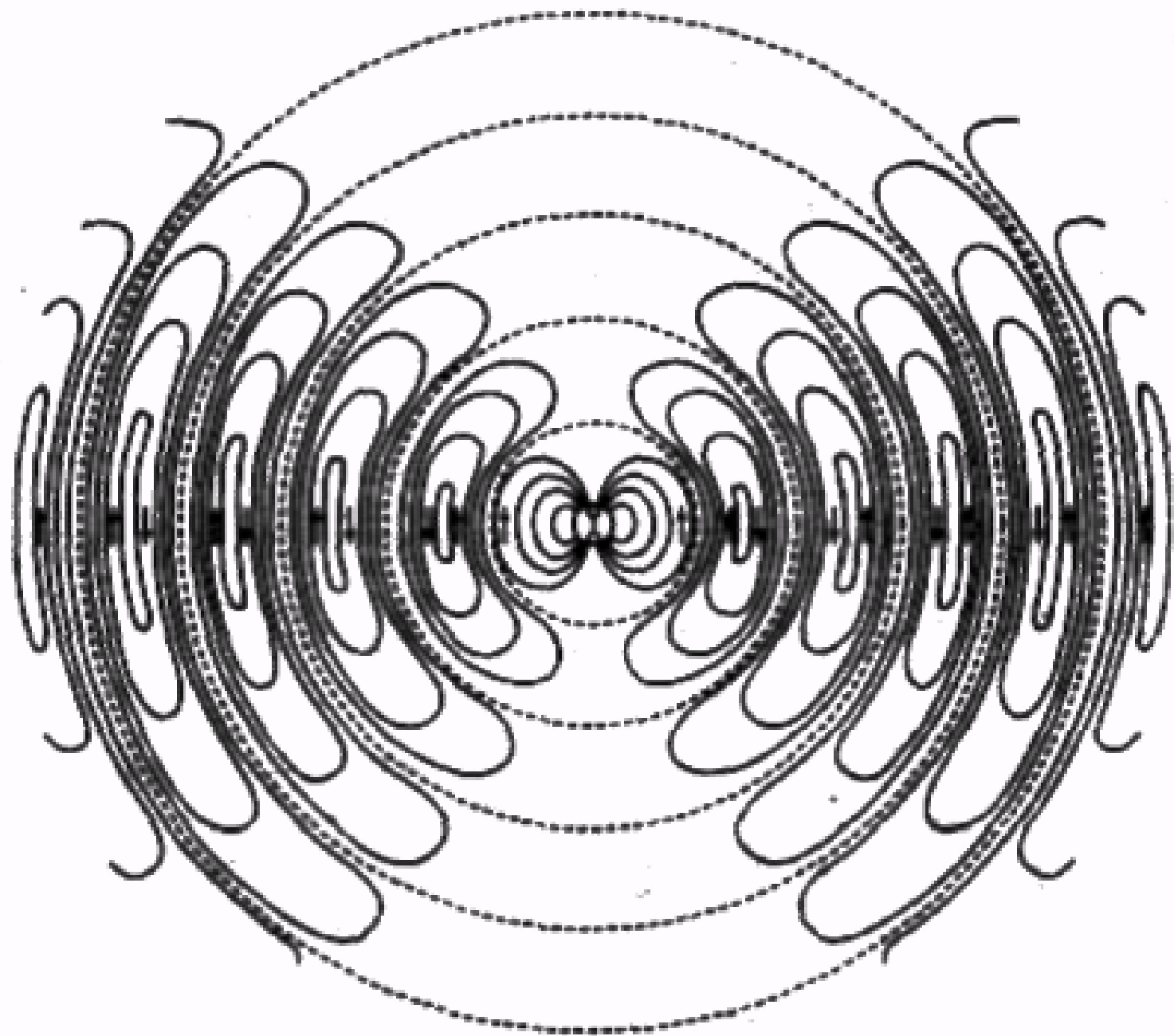

Мал. 2.177

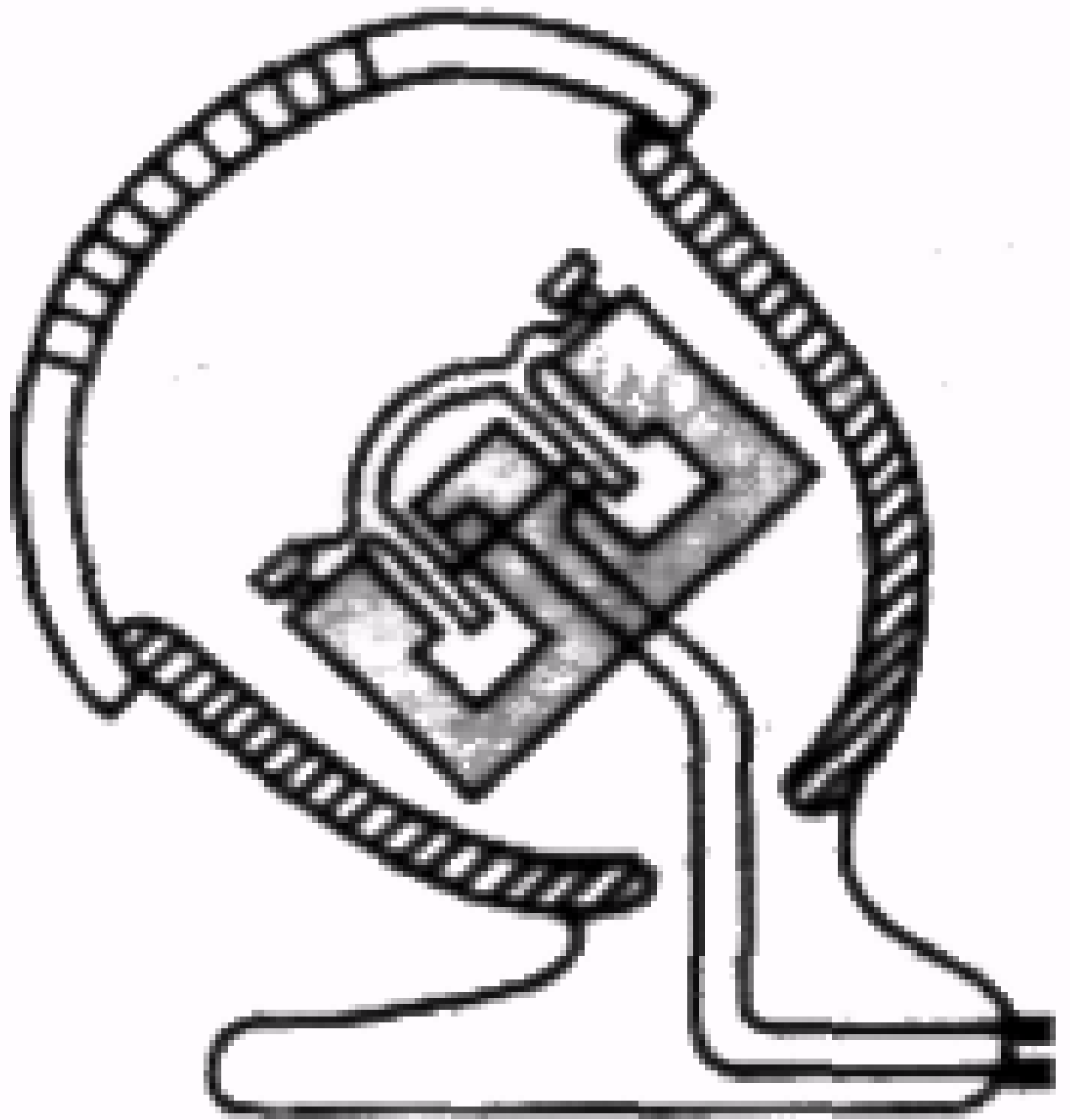

Мал. 2.178

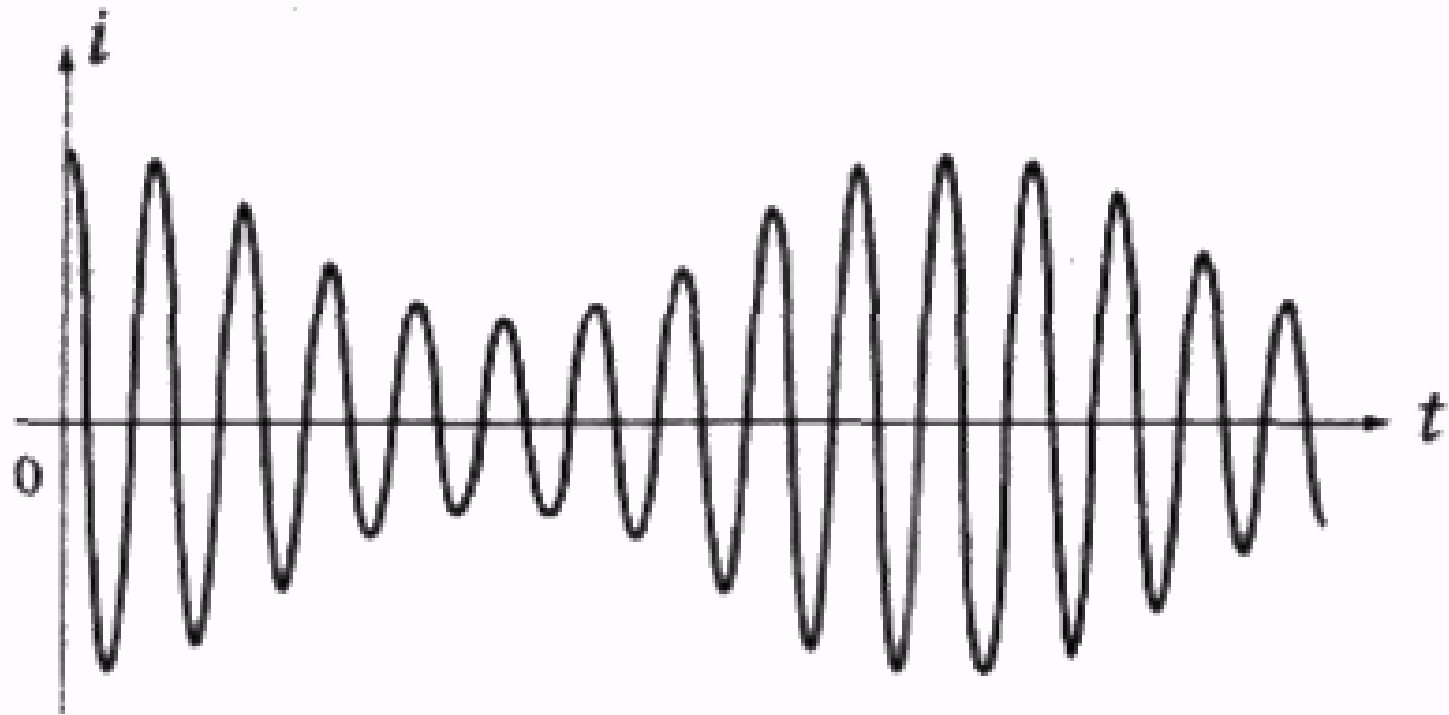

Мал. 2.179

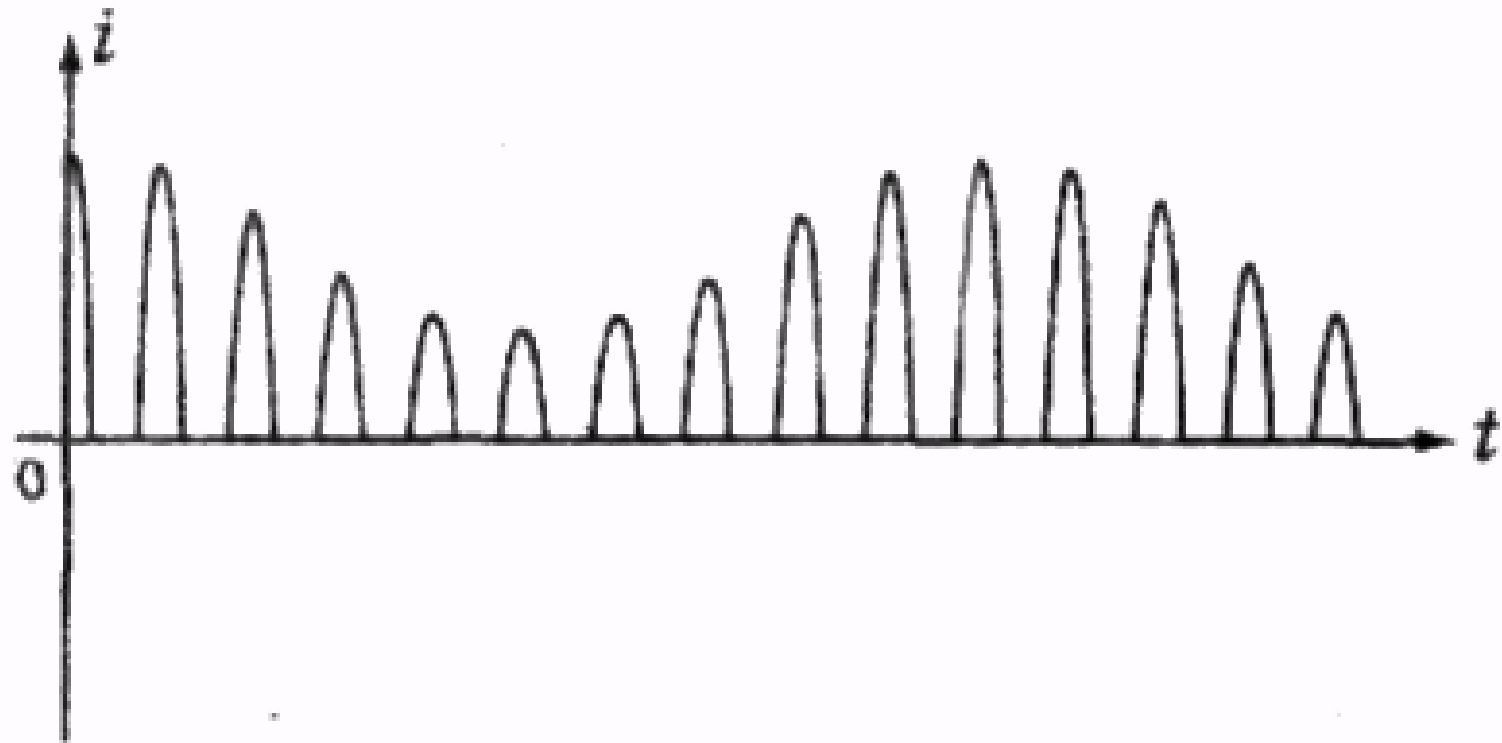

Мал. 2.181

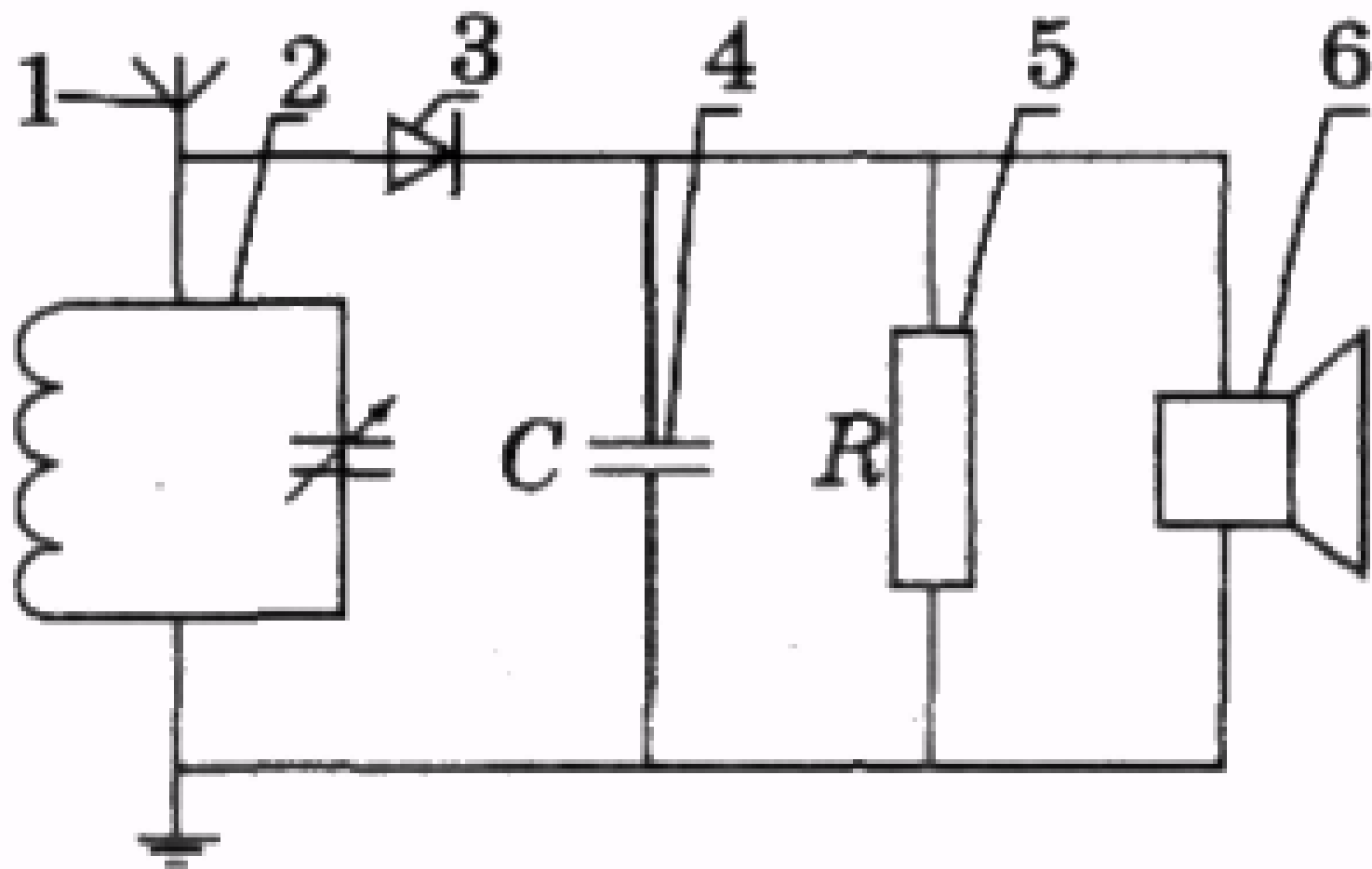

Мал. 2.180

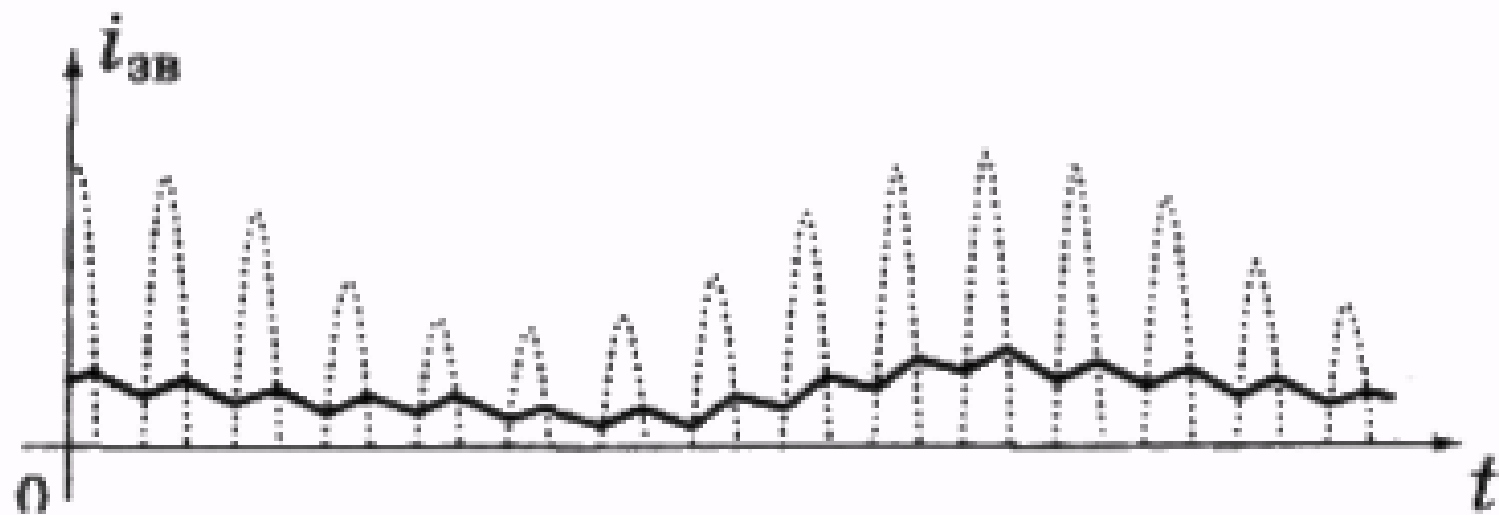

Мал. 2.182

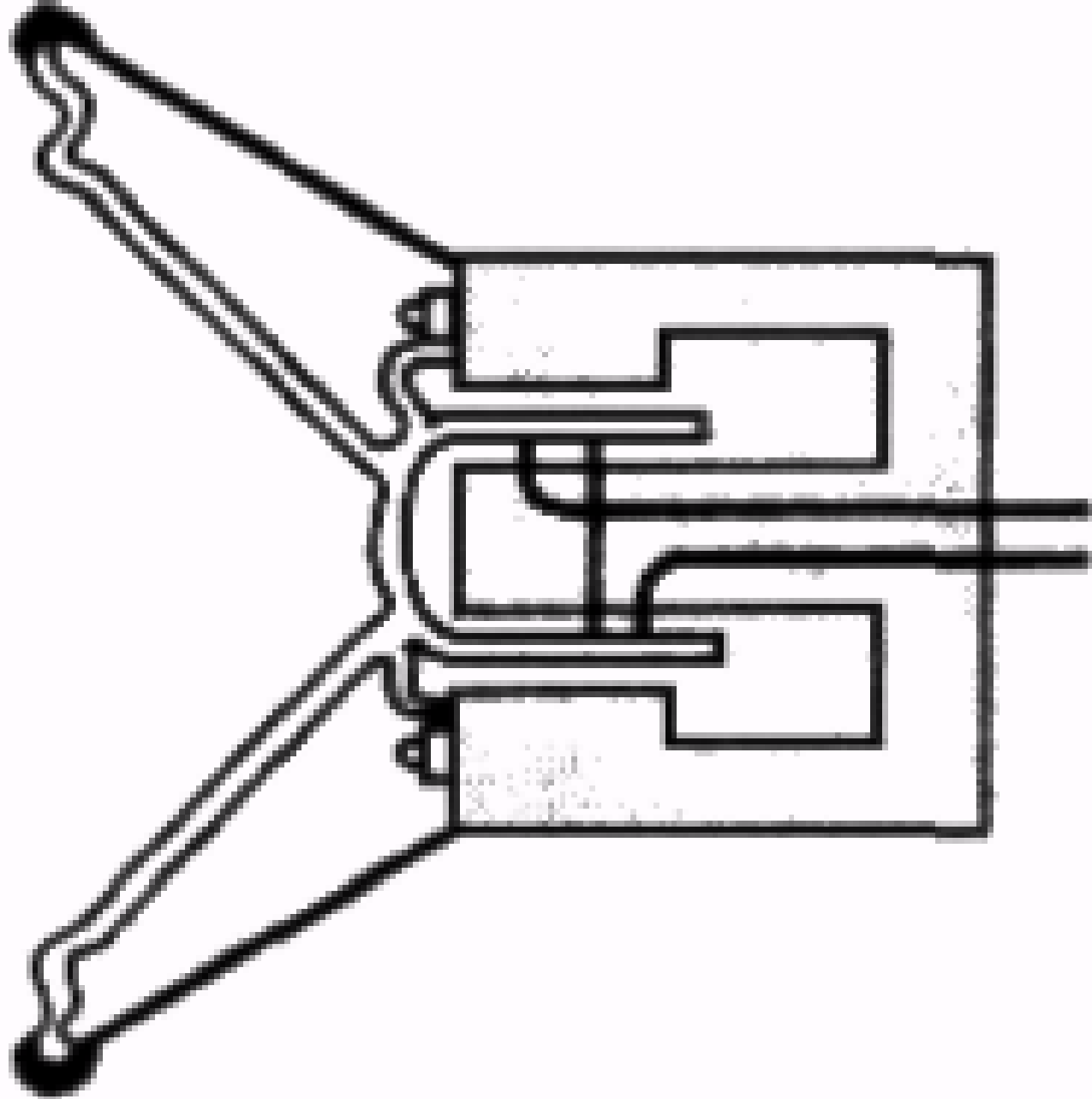

Мал. 2.183

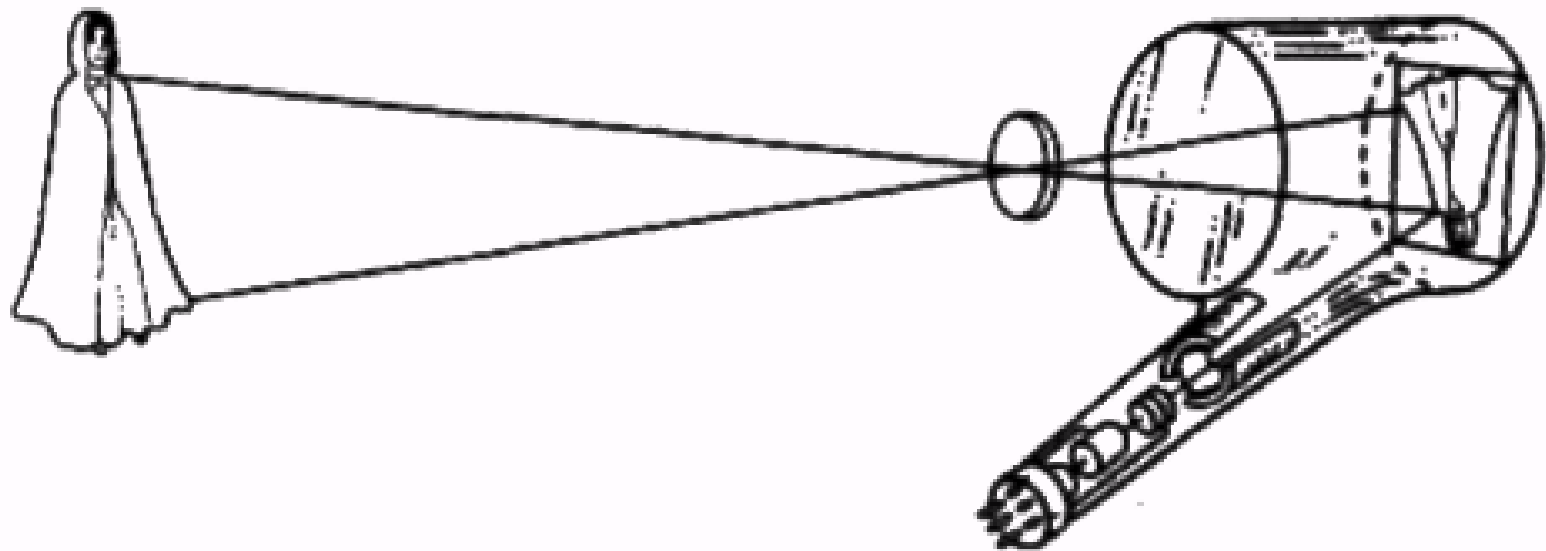

Мал. 2.184

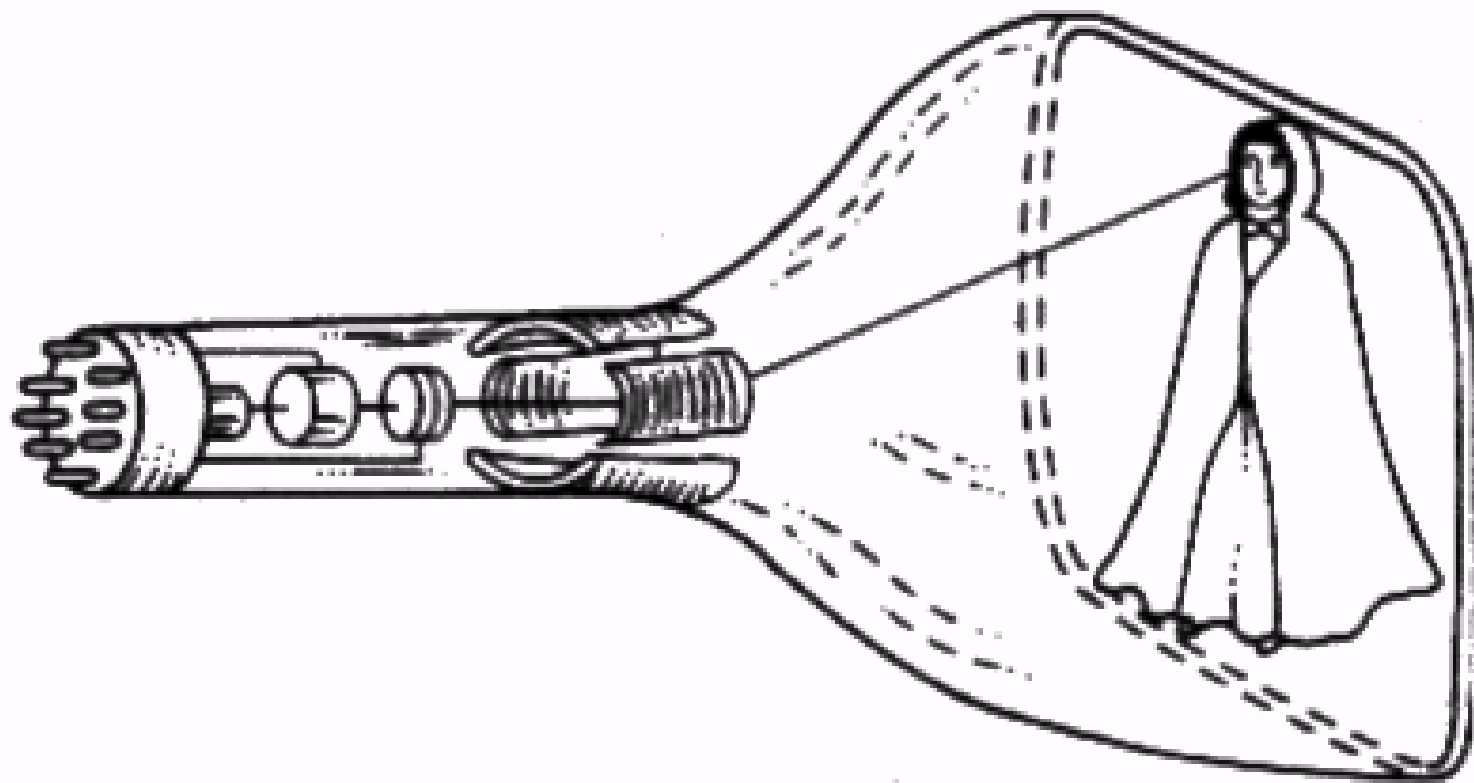

Мал. 2.185

1

=

ct

*

2



Мал. 2.186



Мал. 2.187

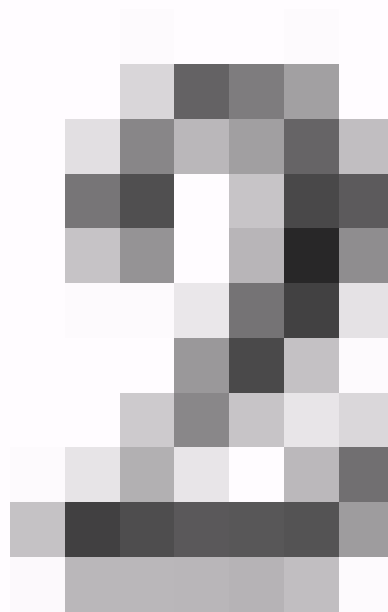
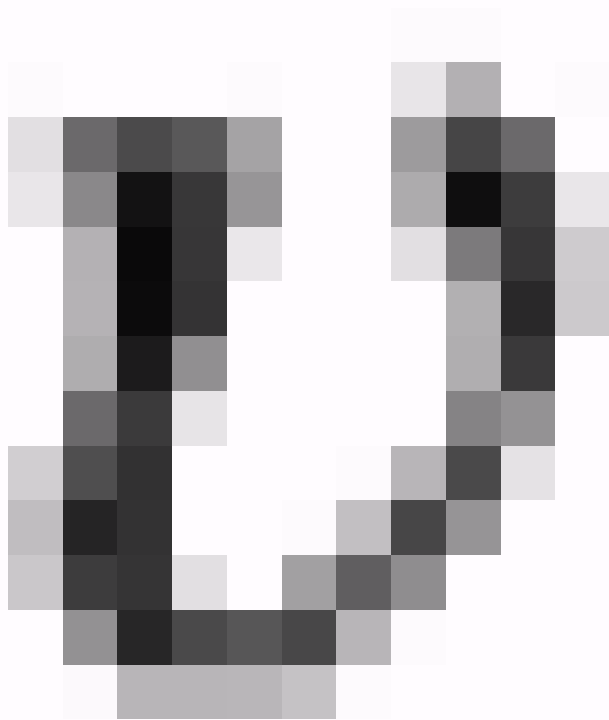

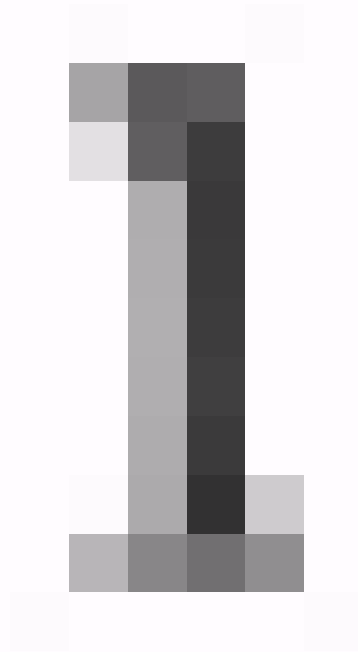
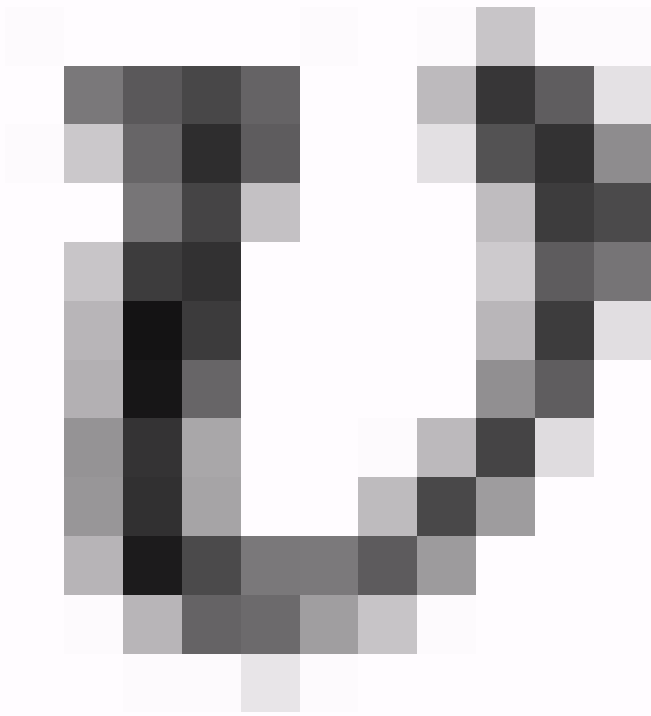

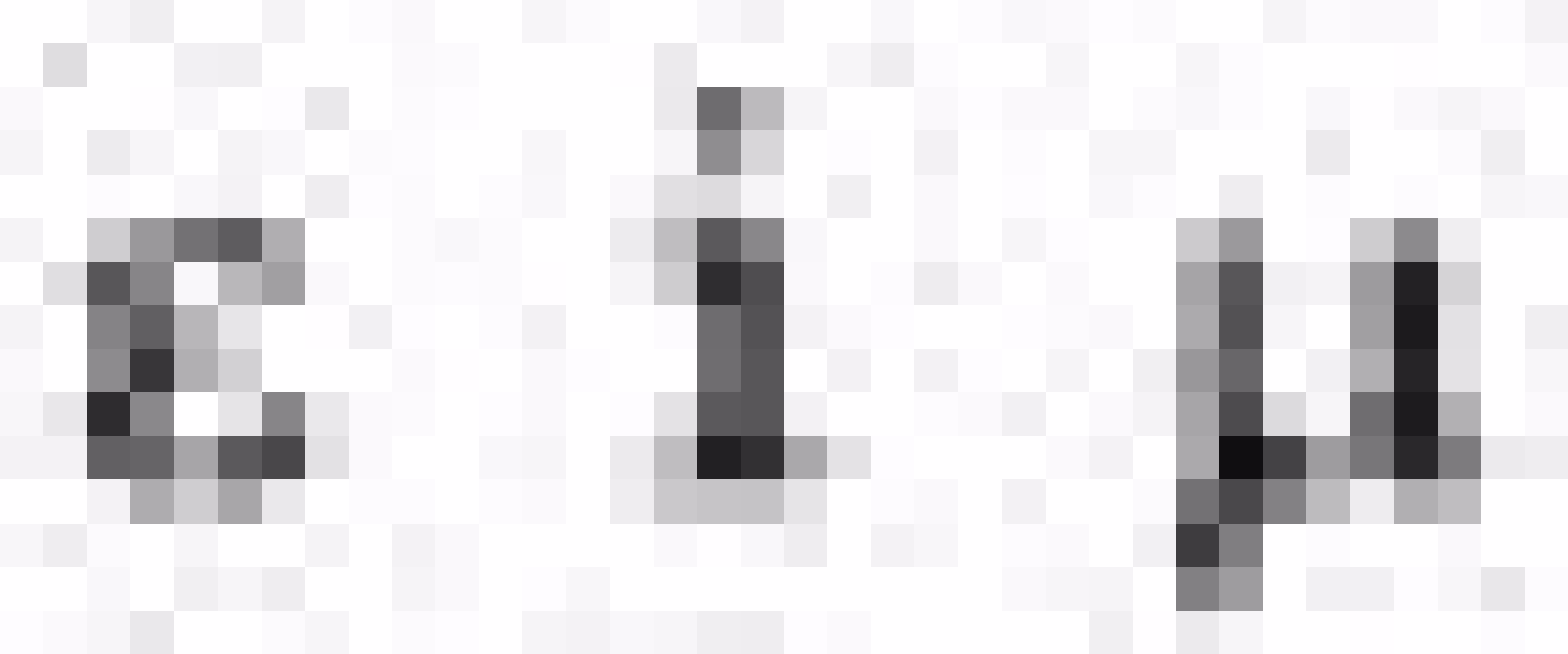

$$v = \frac{v_1 + v_2}{1 + \frac{v_1 v_2}{c^2}} \quad (54.1).$$

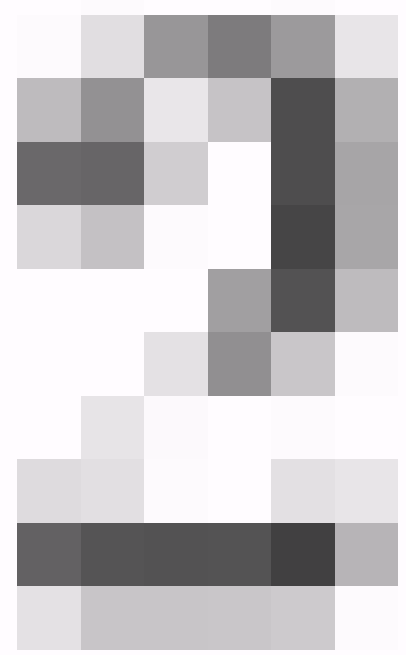
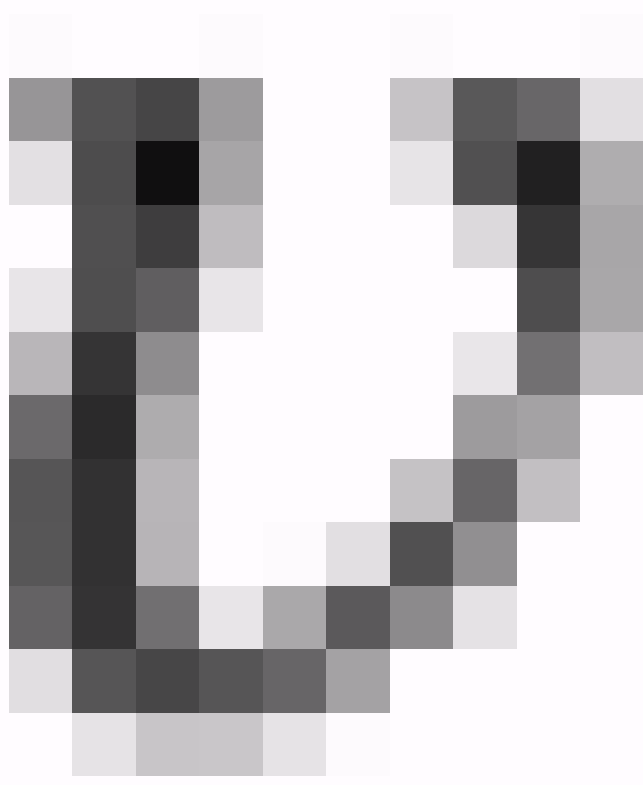

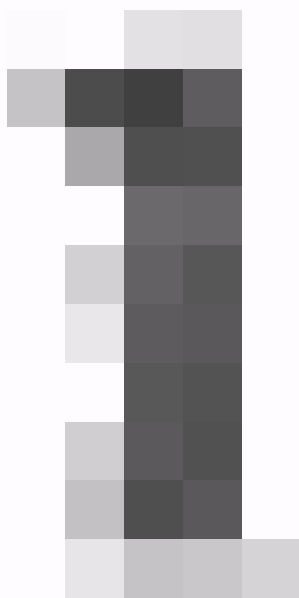
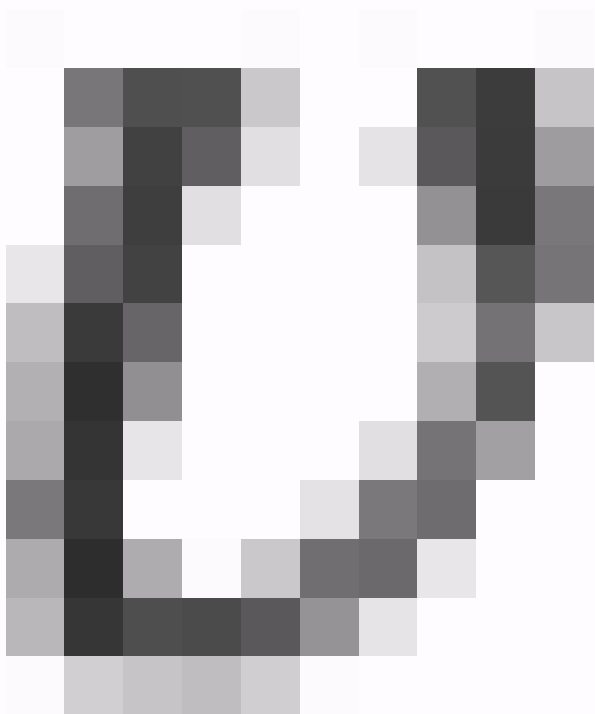

WORLD OF WARRIORS

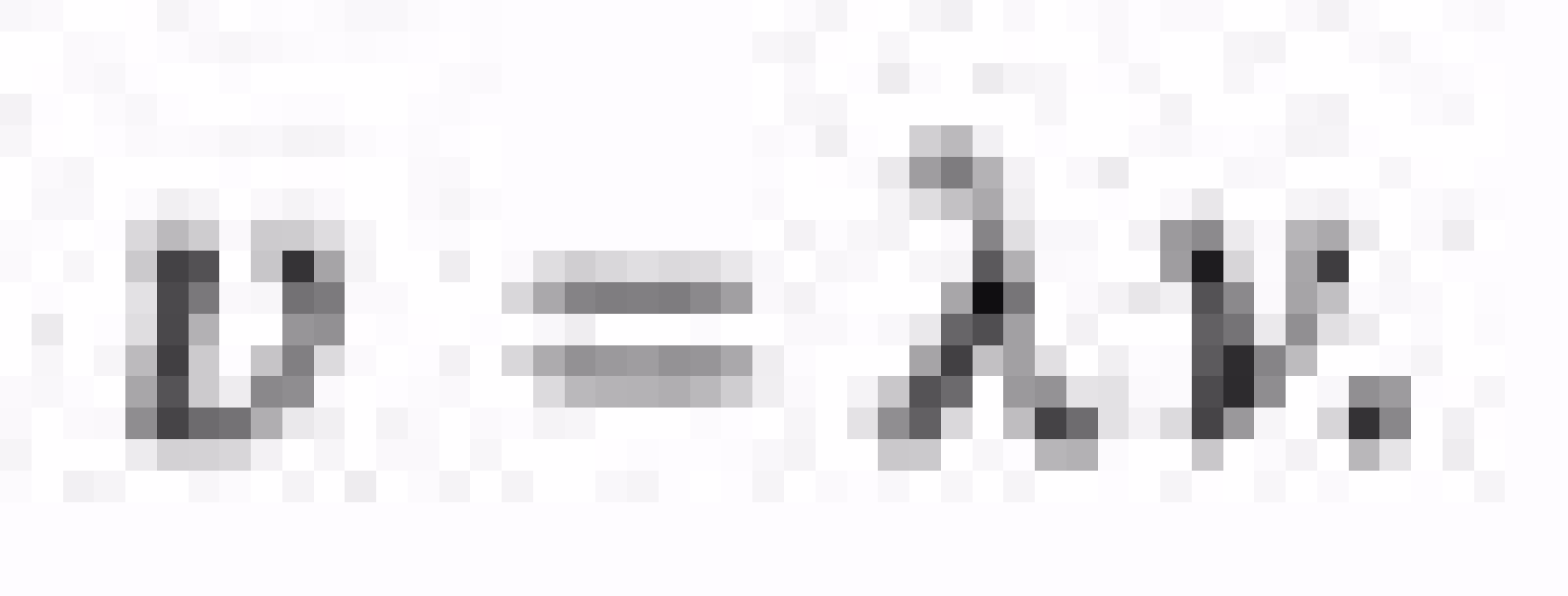

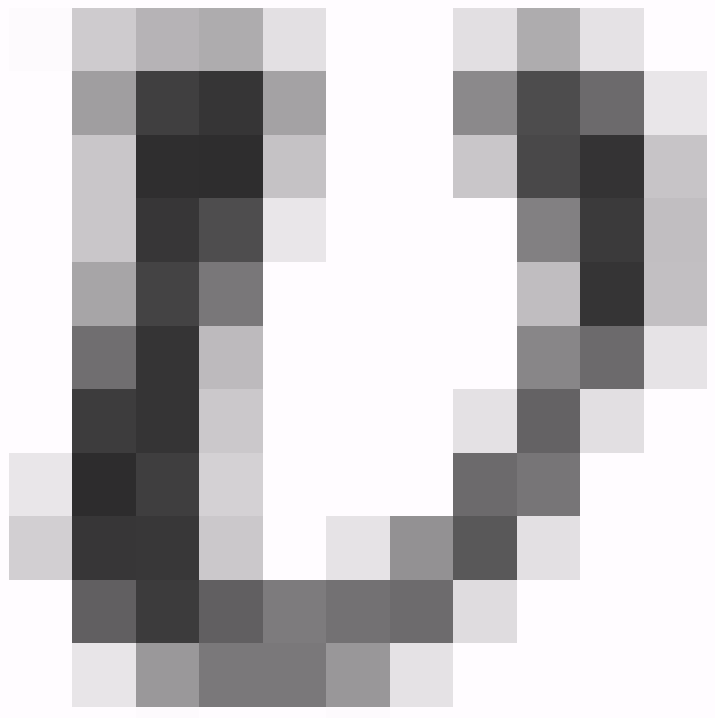
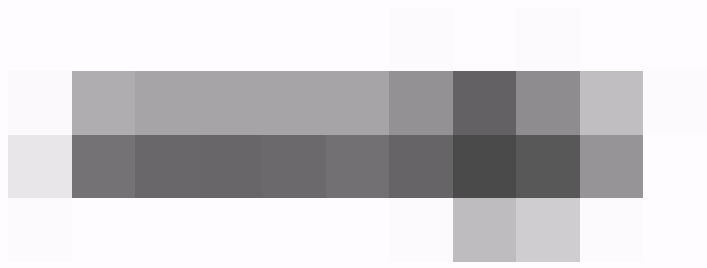

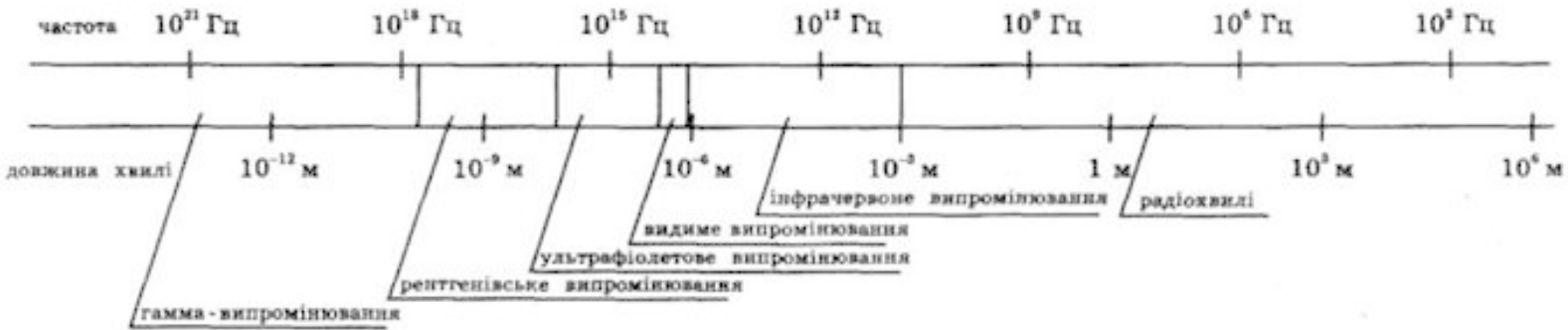

Мал. 2.172

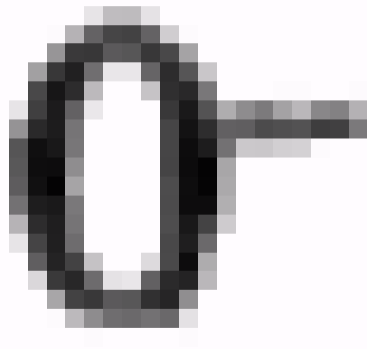
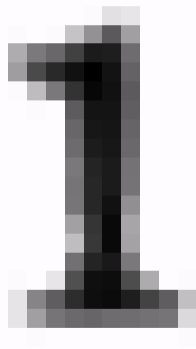
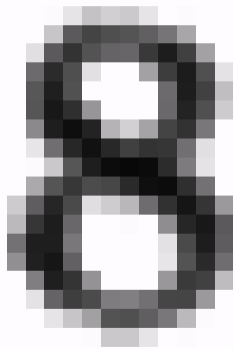

$$\vec{p} = \frac{m\vec{v}}{\sqrt{1 - \frac{v^2}{c^2}}} \quad (54.2).$$

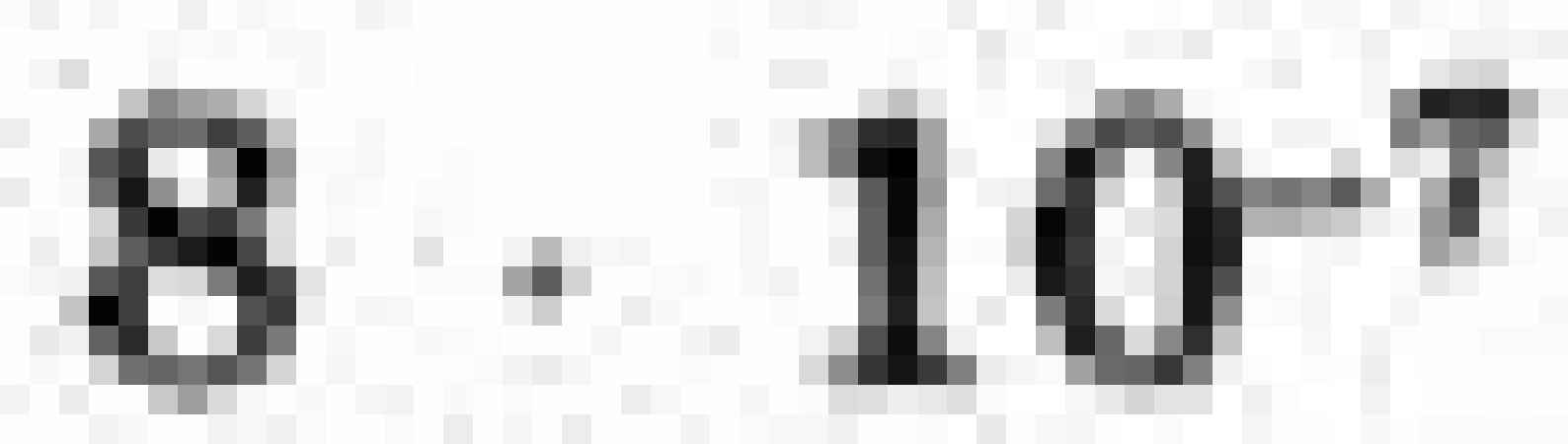

9

.

107

10

107

.

107

107

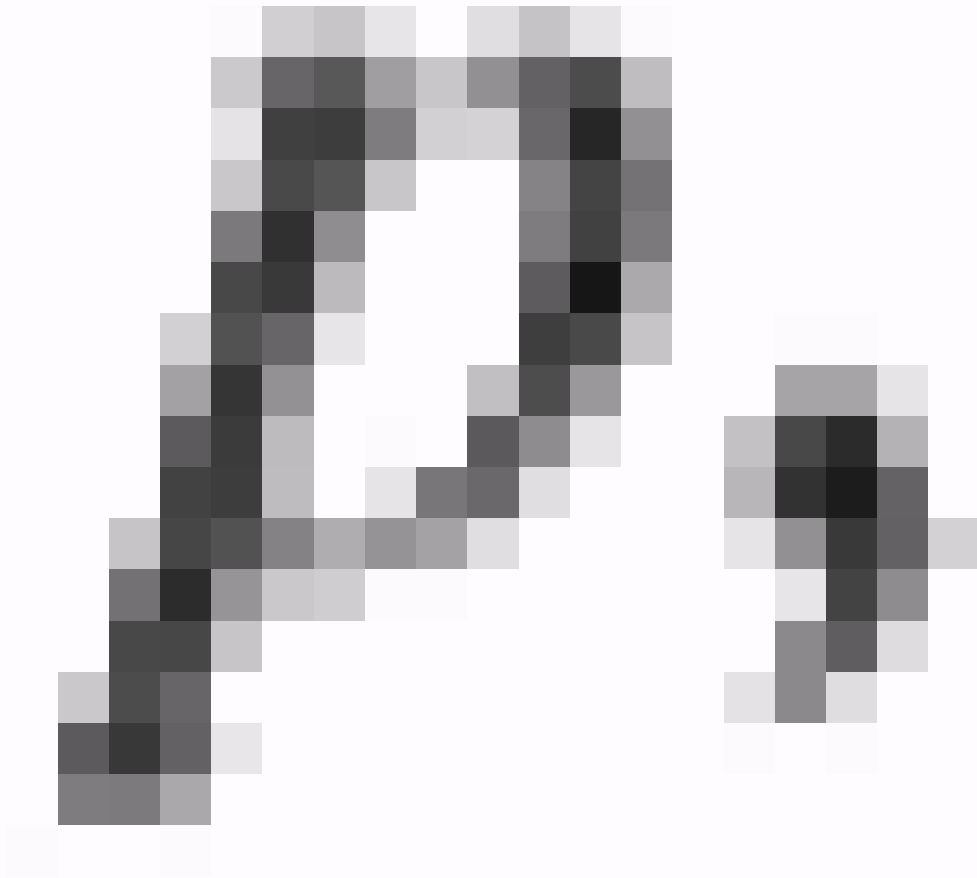
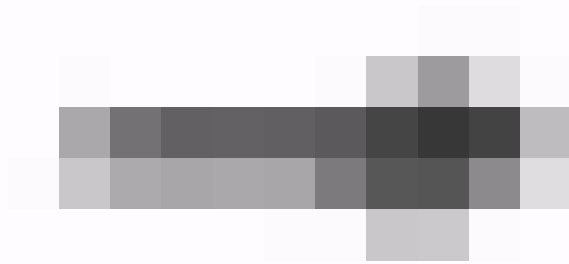

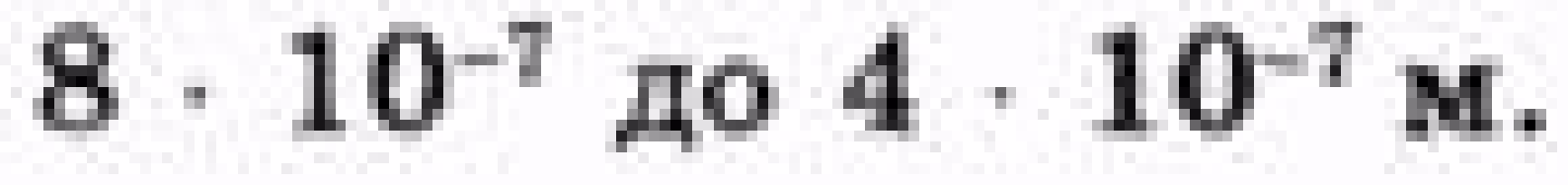

4

.

1

0

—

7

10

0

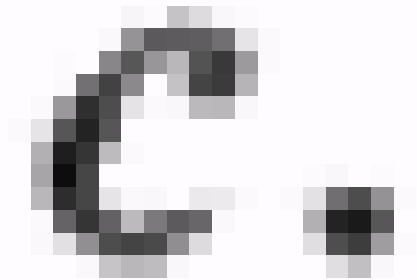
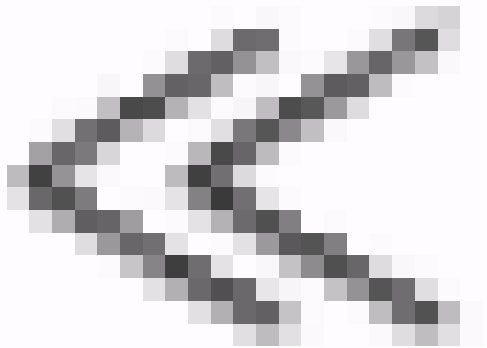
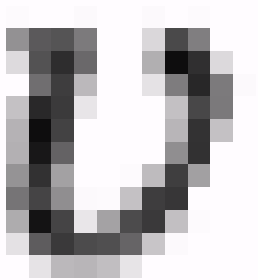

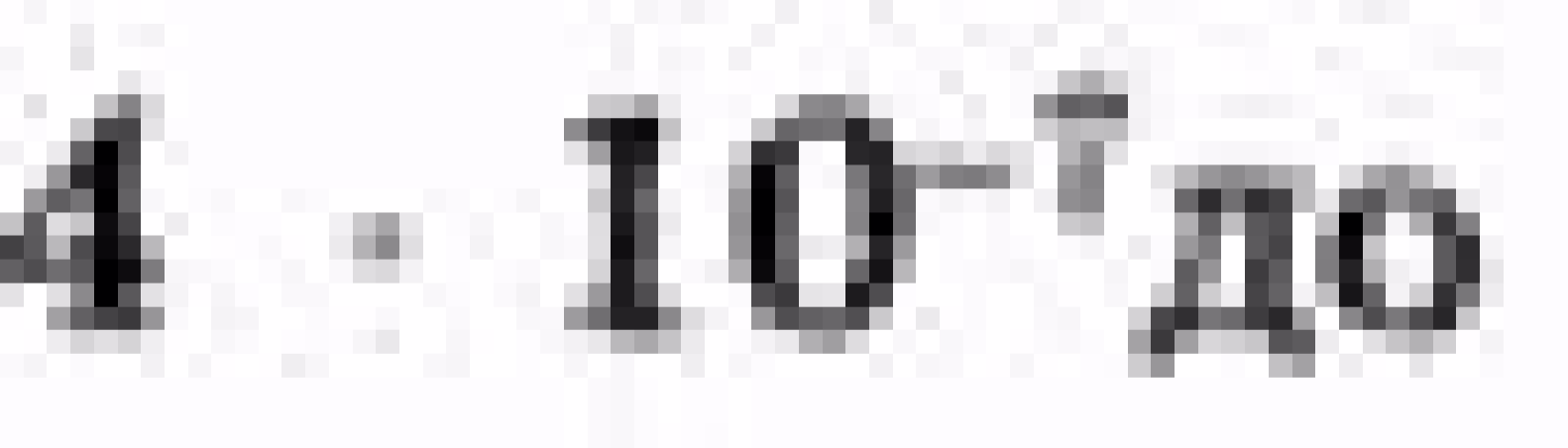

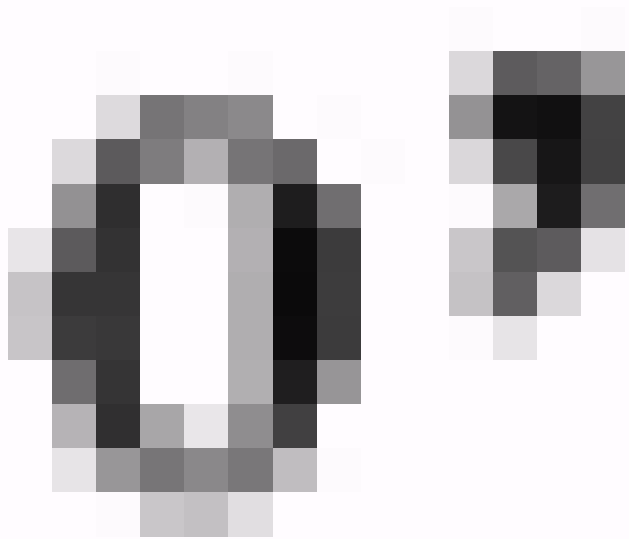
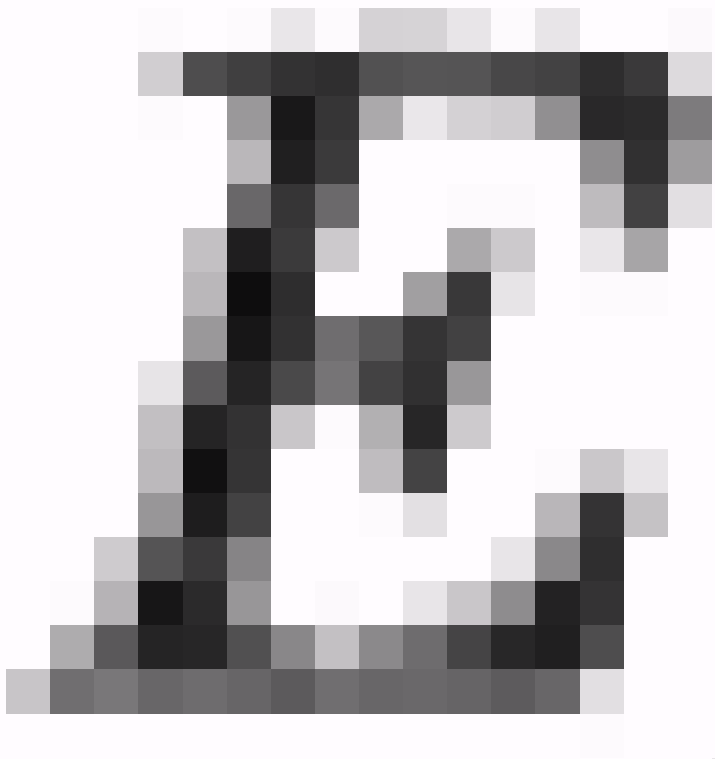

$$E_n = mc^2 (54.9)$$

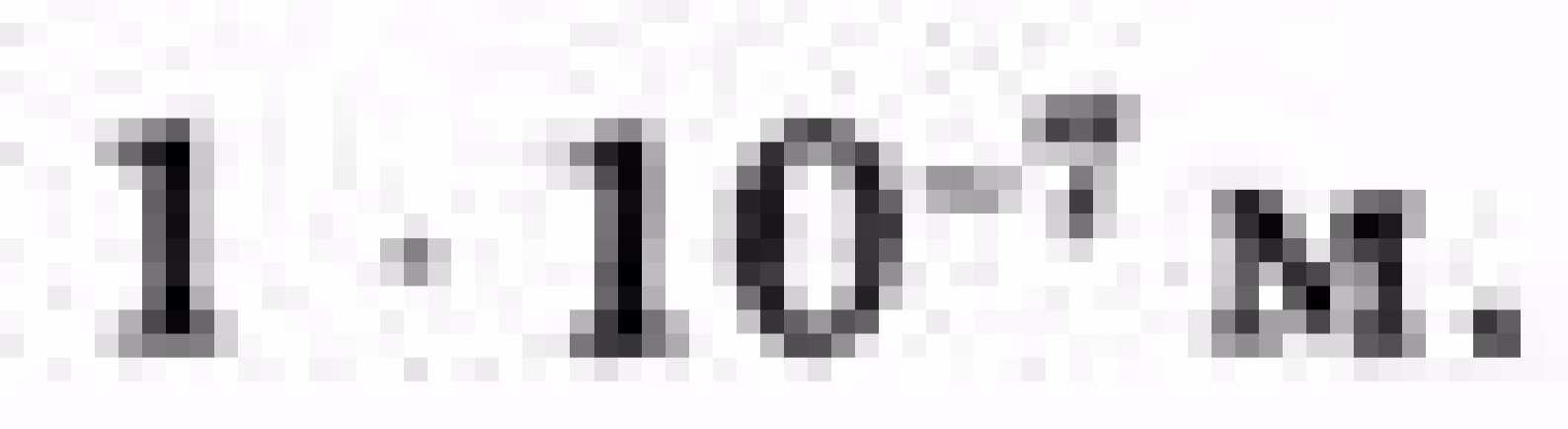

1000

1000

1000

1000

$$E = \frac{mc^2}{\sqrt{1 - \frac{v^2}{c^2}}} \quad (54.4).$$

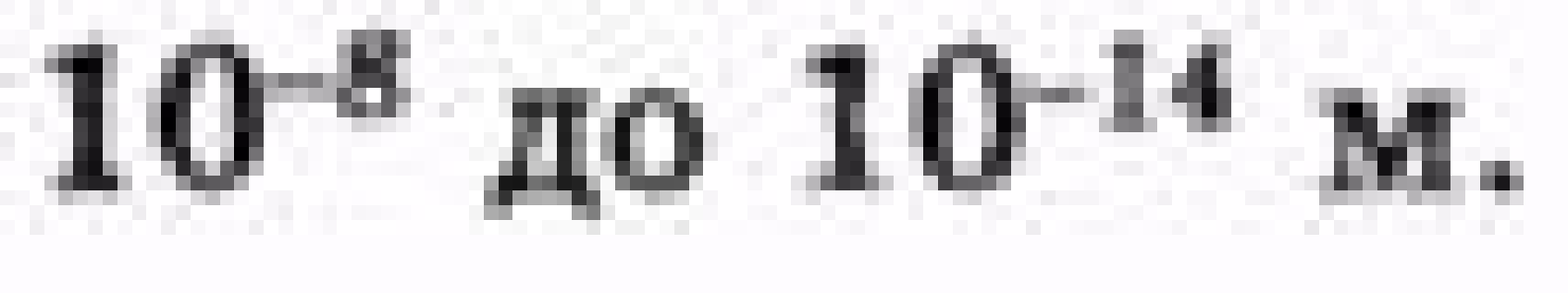

1010 110

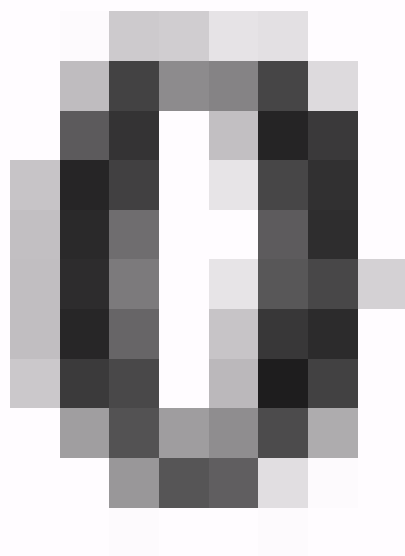
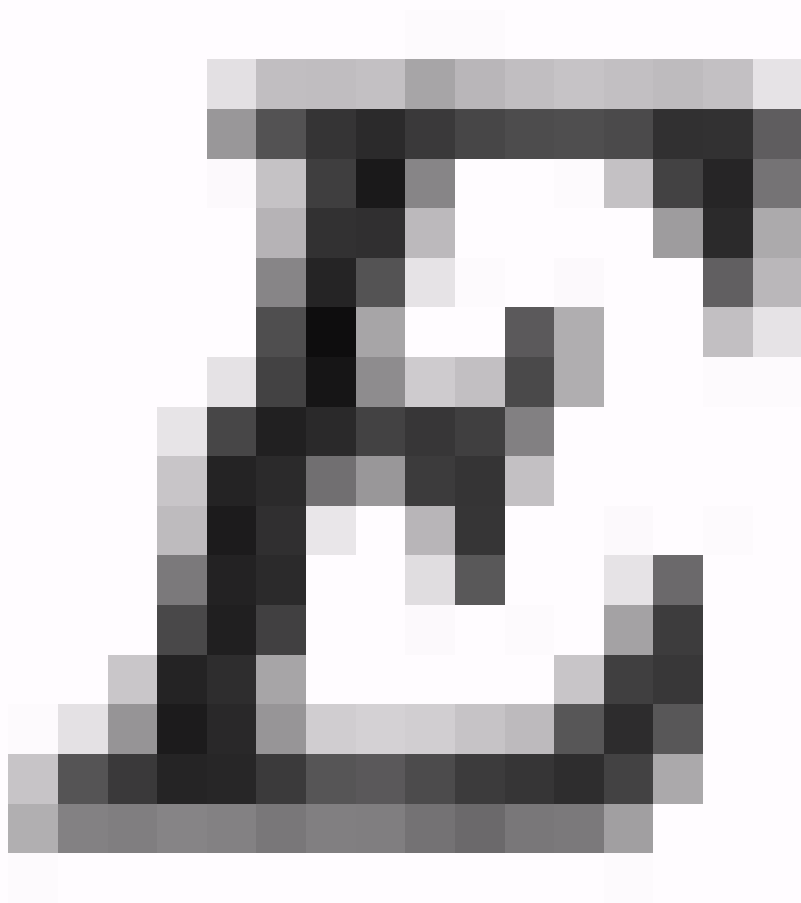

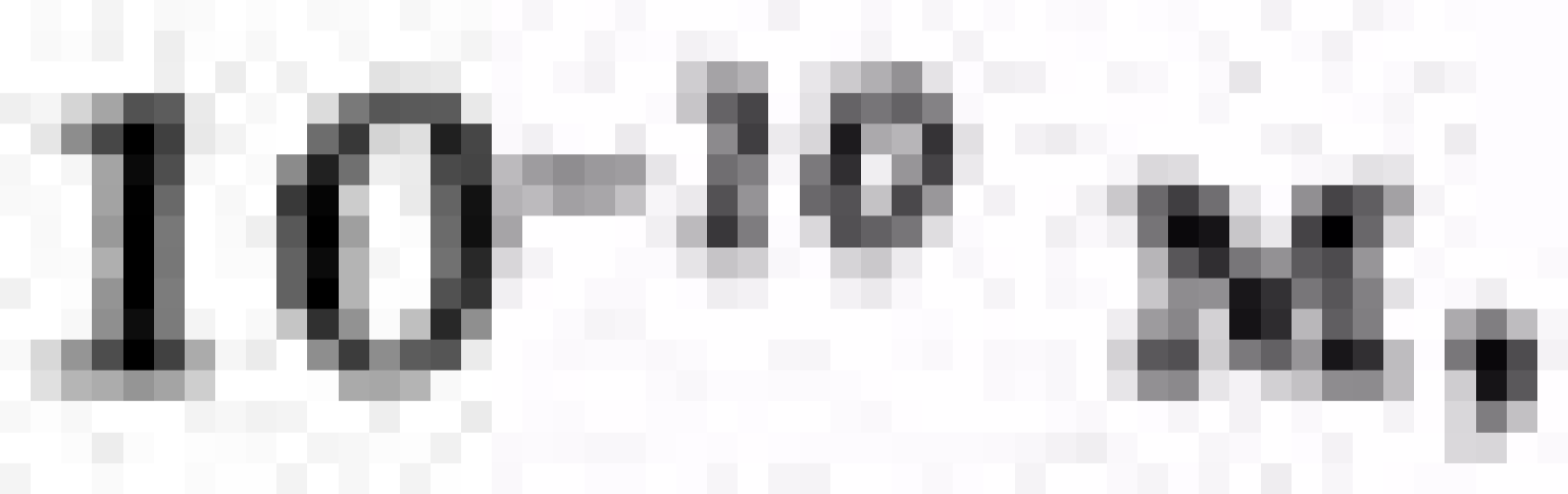

10-10

10

10-10

10

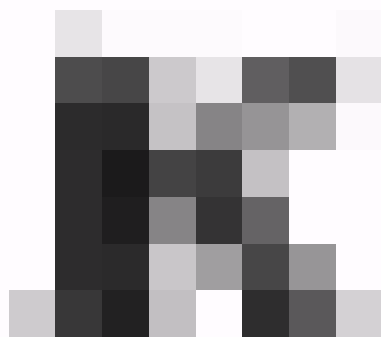
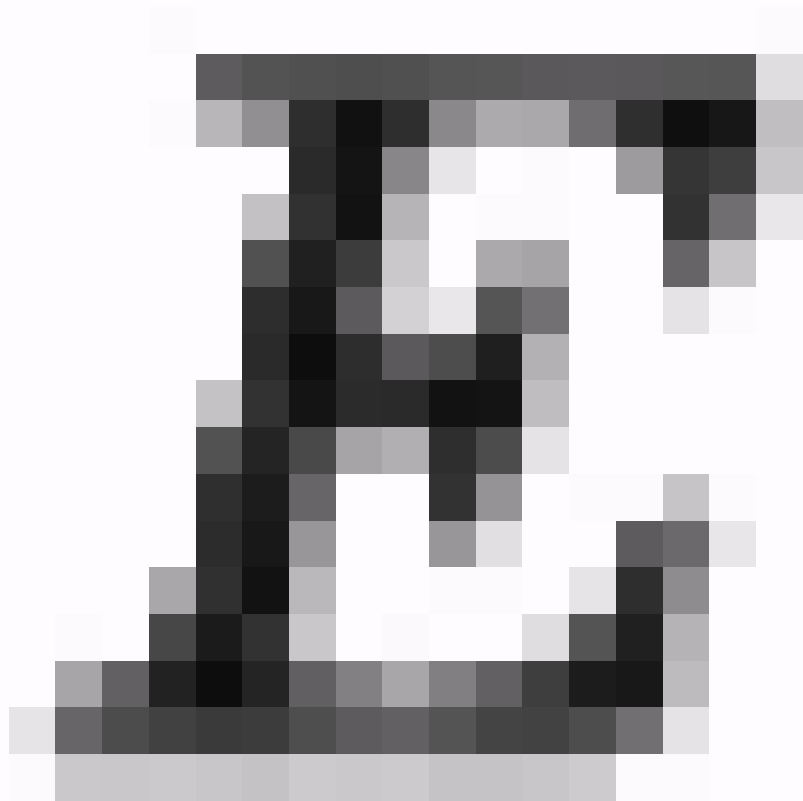



$E = E - E_0$

(54.5)

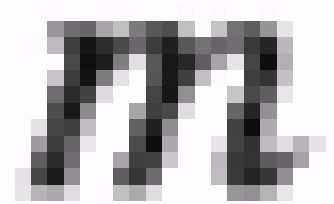
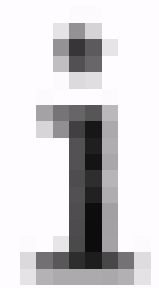
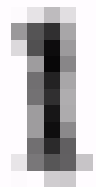
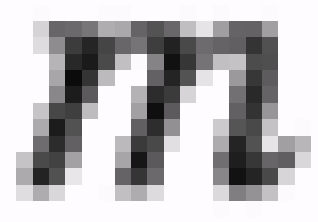

10

i

10

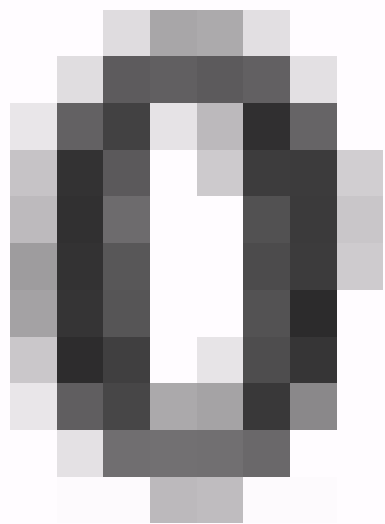
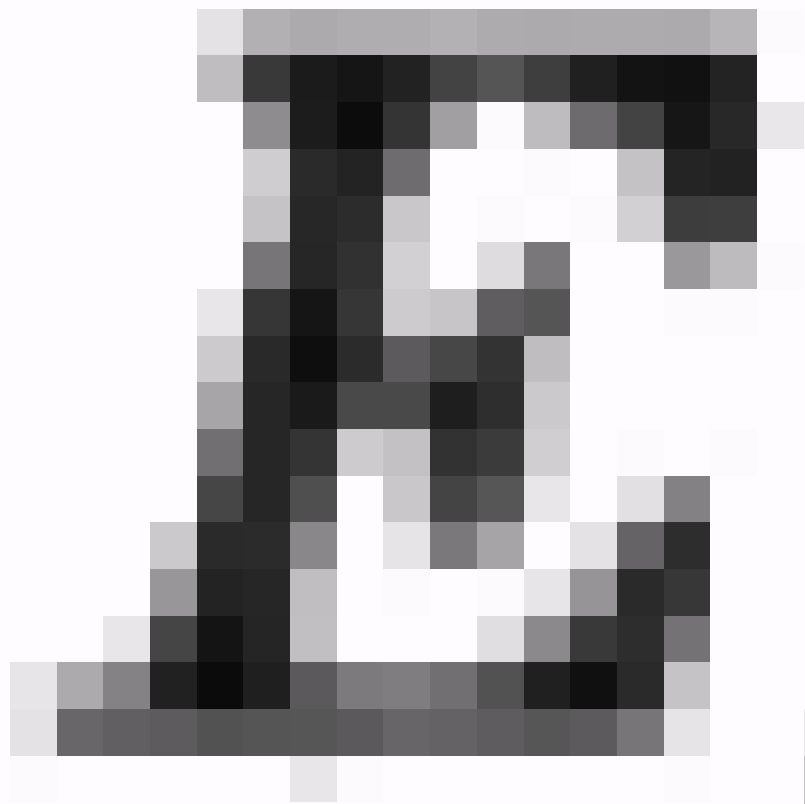



$$E_0 = E_{0_1} + E_{0_2} + W \quad (54.6)$$

$$\frac{E_0}{c^2} = \frac{E_{0_1}}{c^2} + \frac{E_{0_2}}{c^2} + \frac{W}{c^2} \quad (54.7),$$

$$M = m_1 + m_2 + \frac{W}{c^2} \quad (54.8).$$

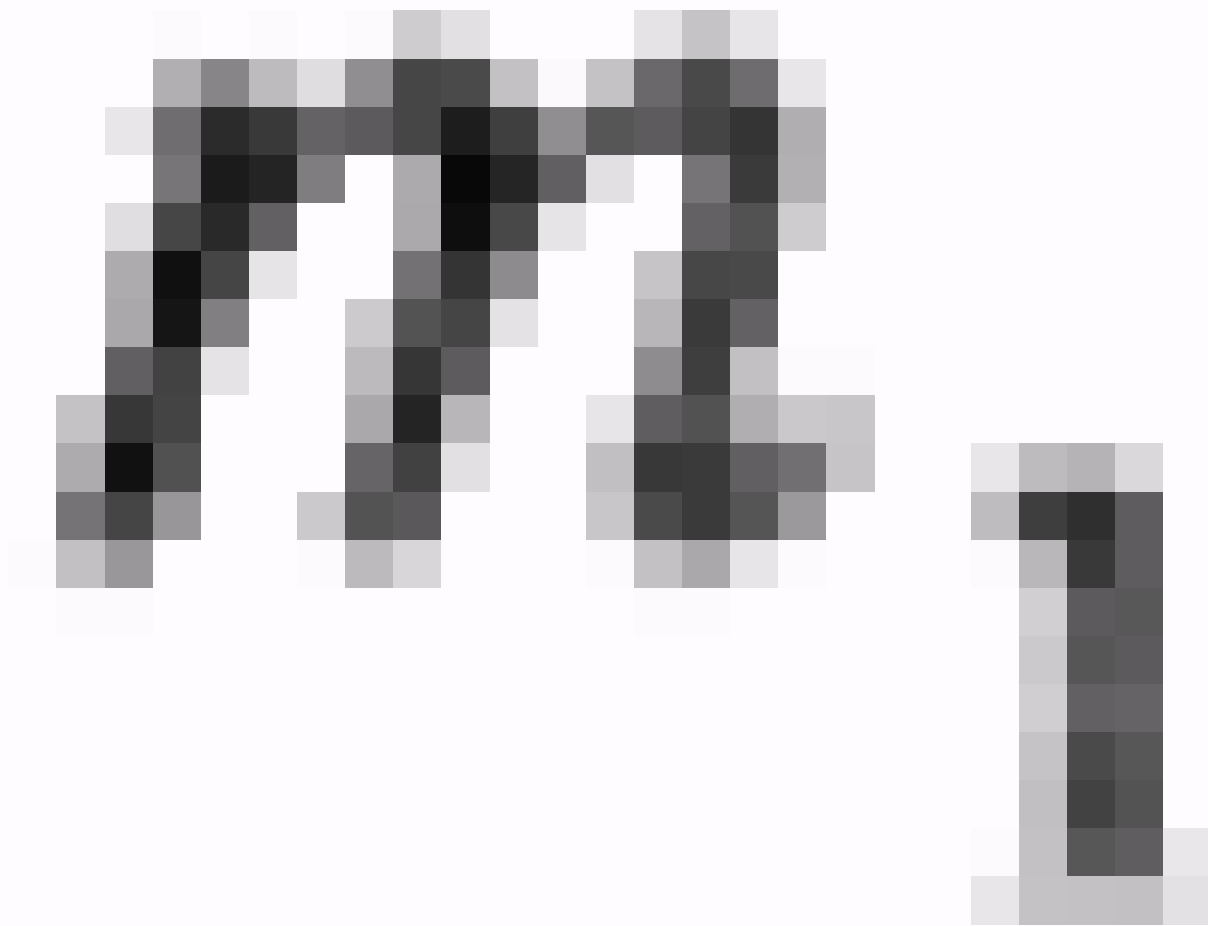

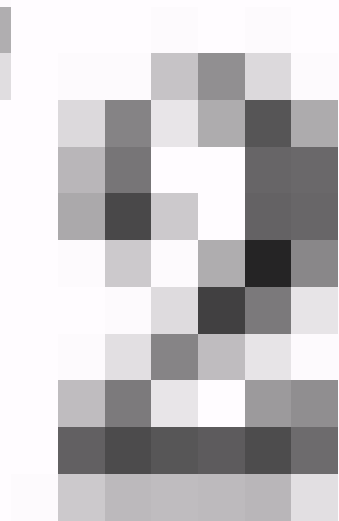
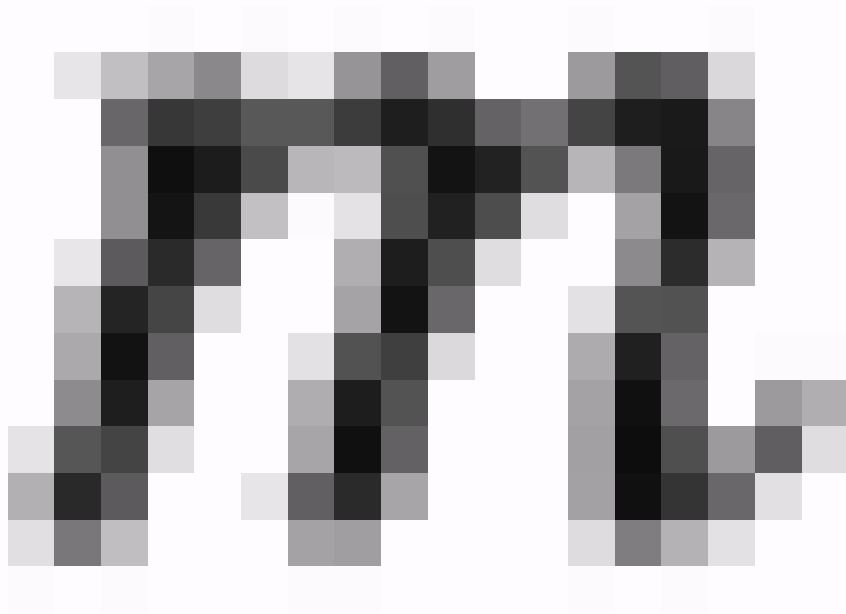

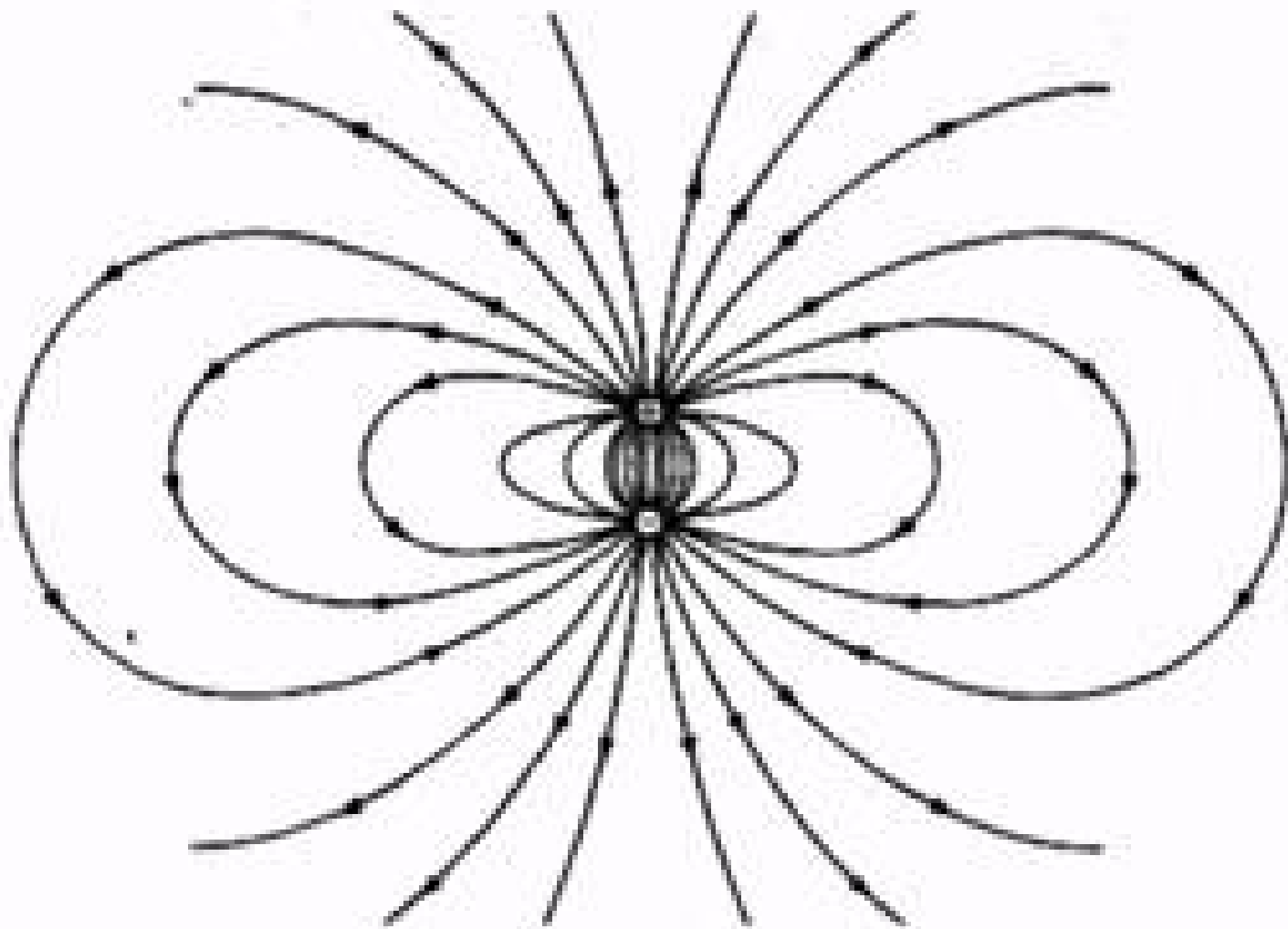

Мал. 2.175



$$\Delta m = m_1 + m_2 - M = -\frac{W}{c^2} \quad (54.9)$$

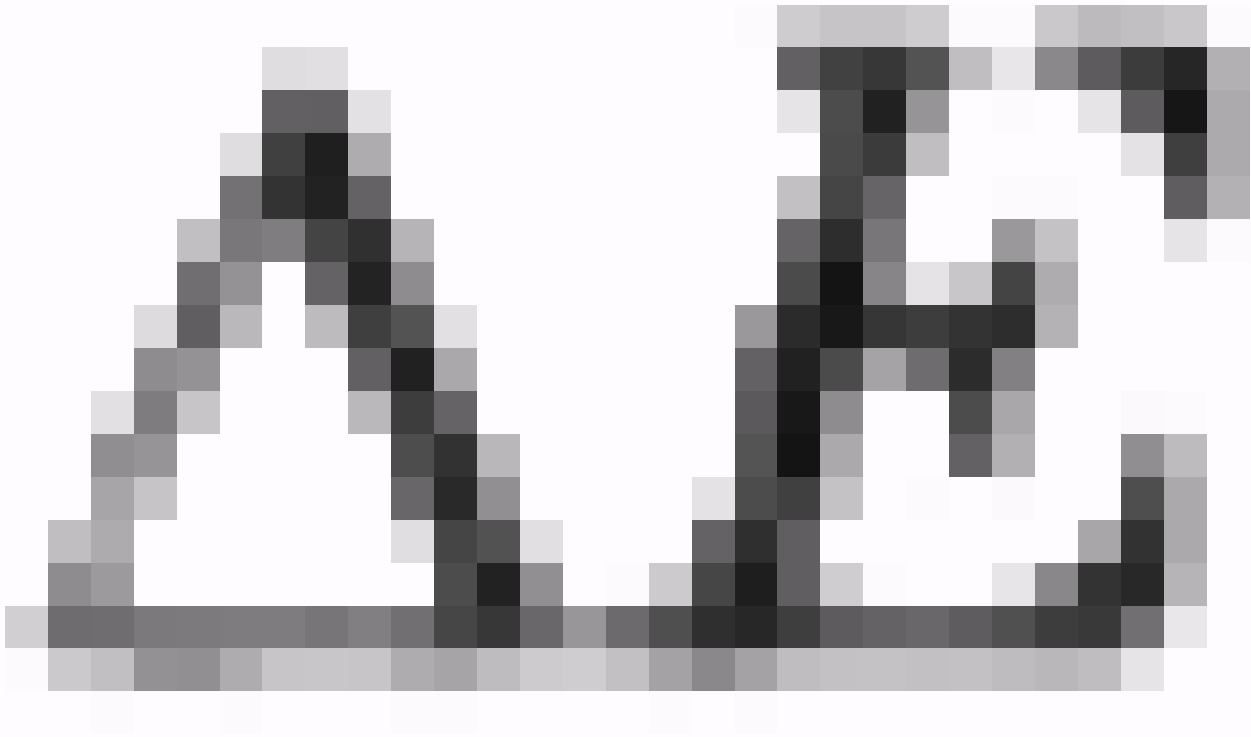

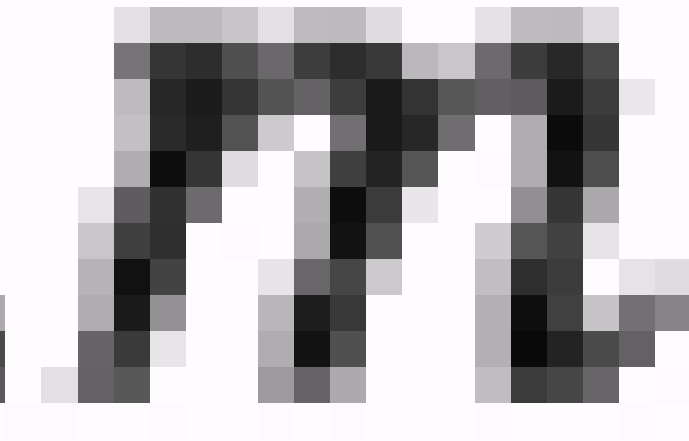
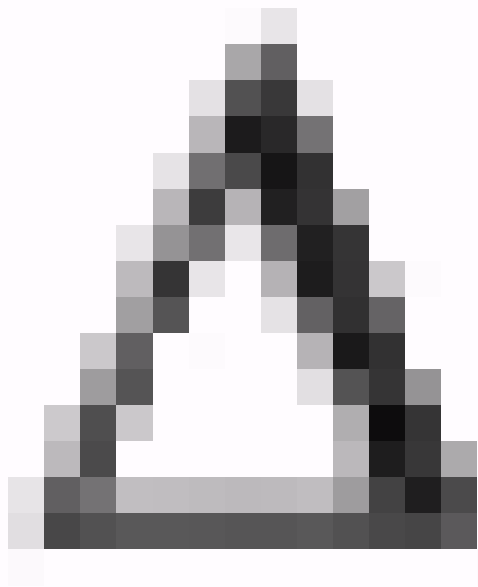

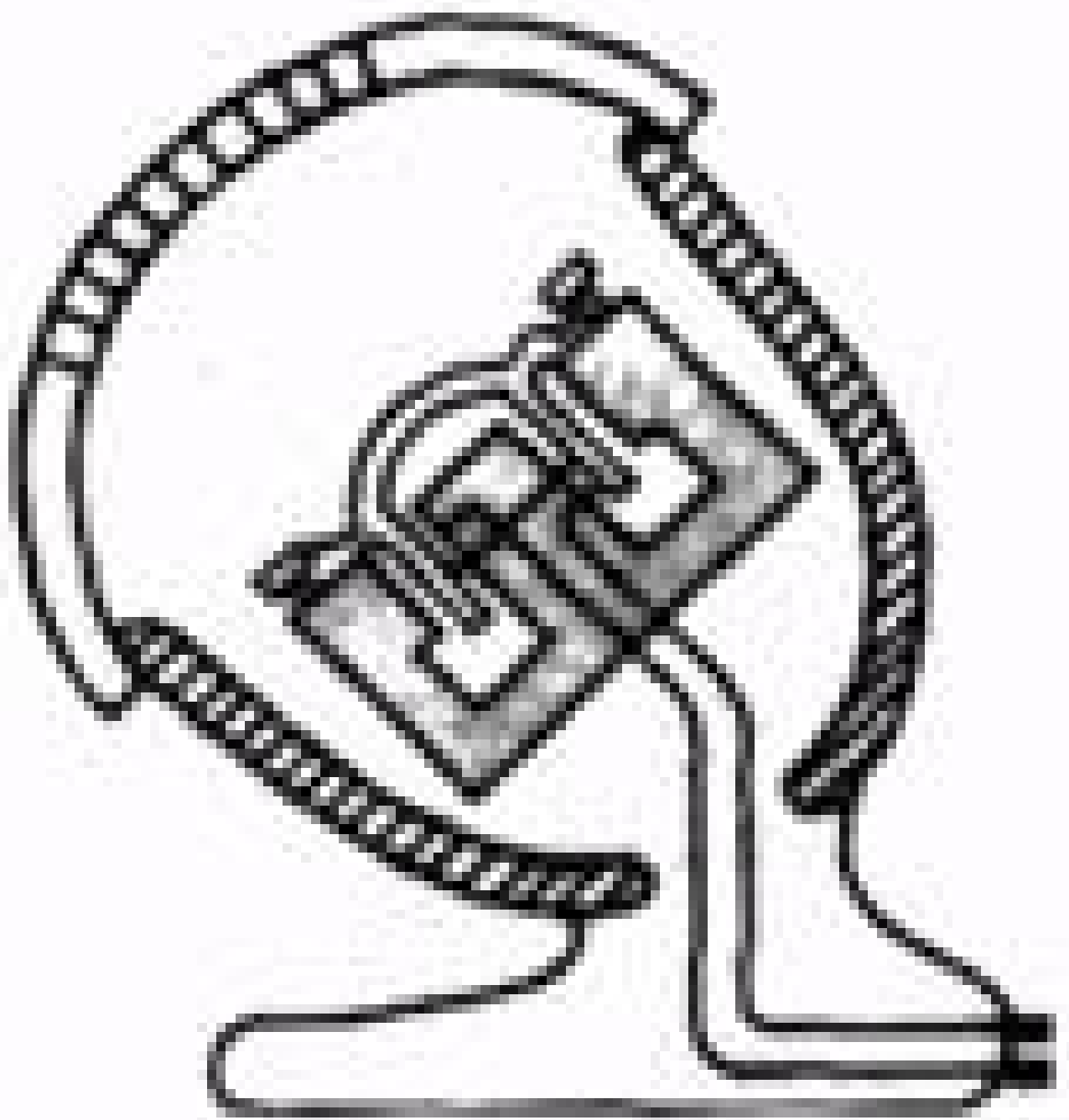

Мол. 2.178

AE

=

amc²

(54.10)

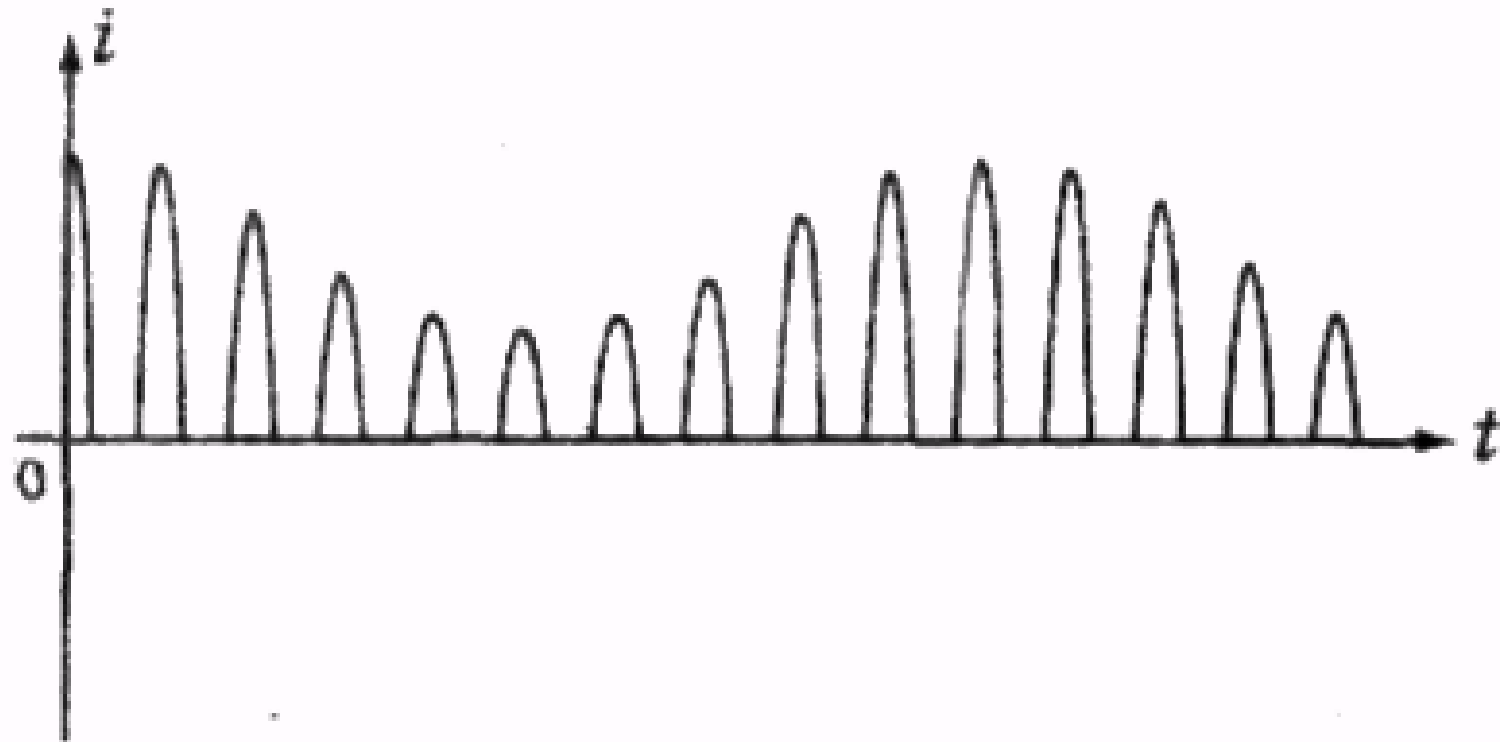

Мал. 2.181

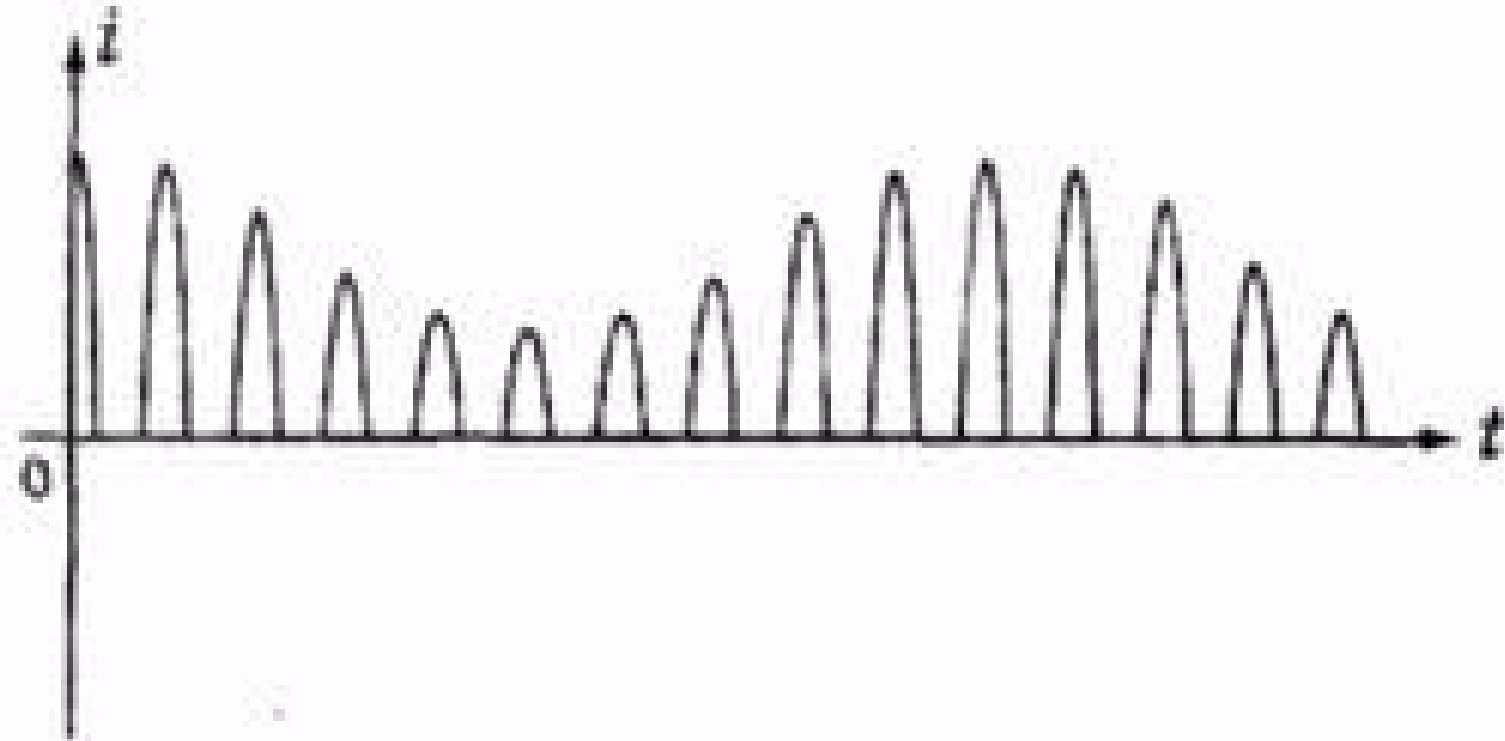

Мал. 2.181

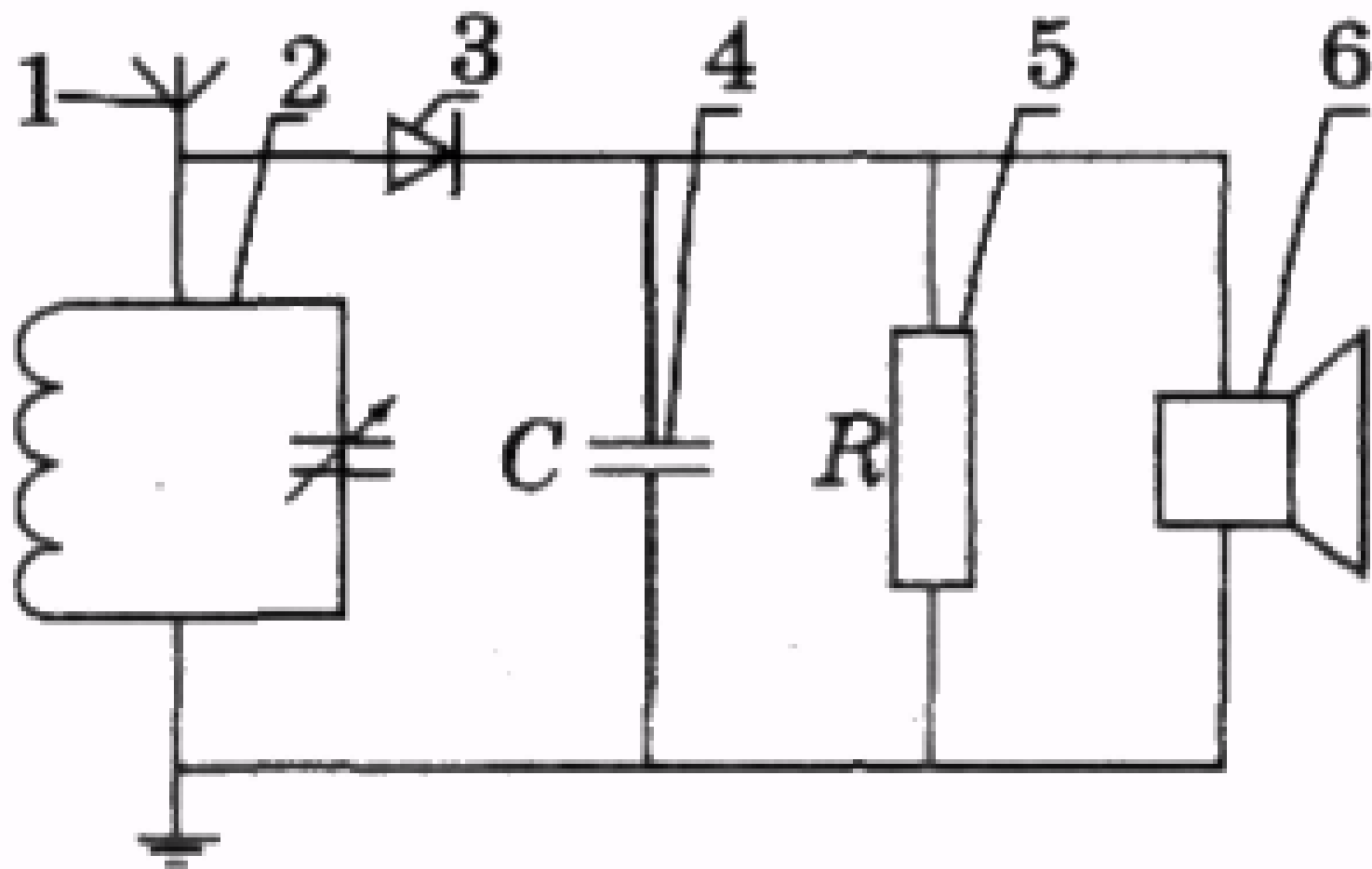

Мал. 2.180

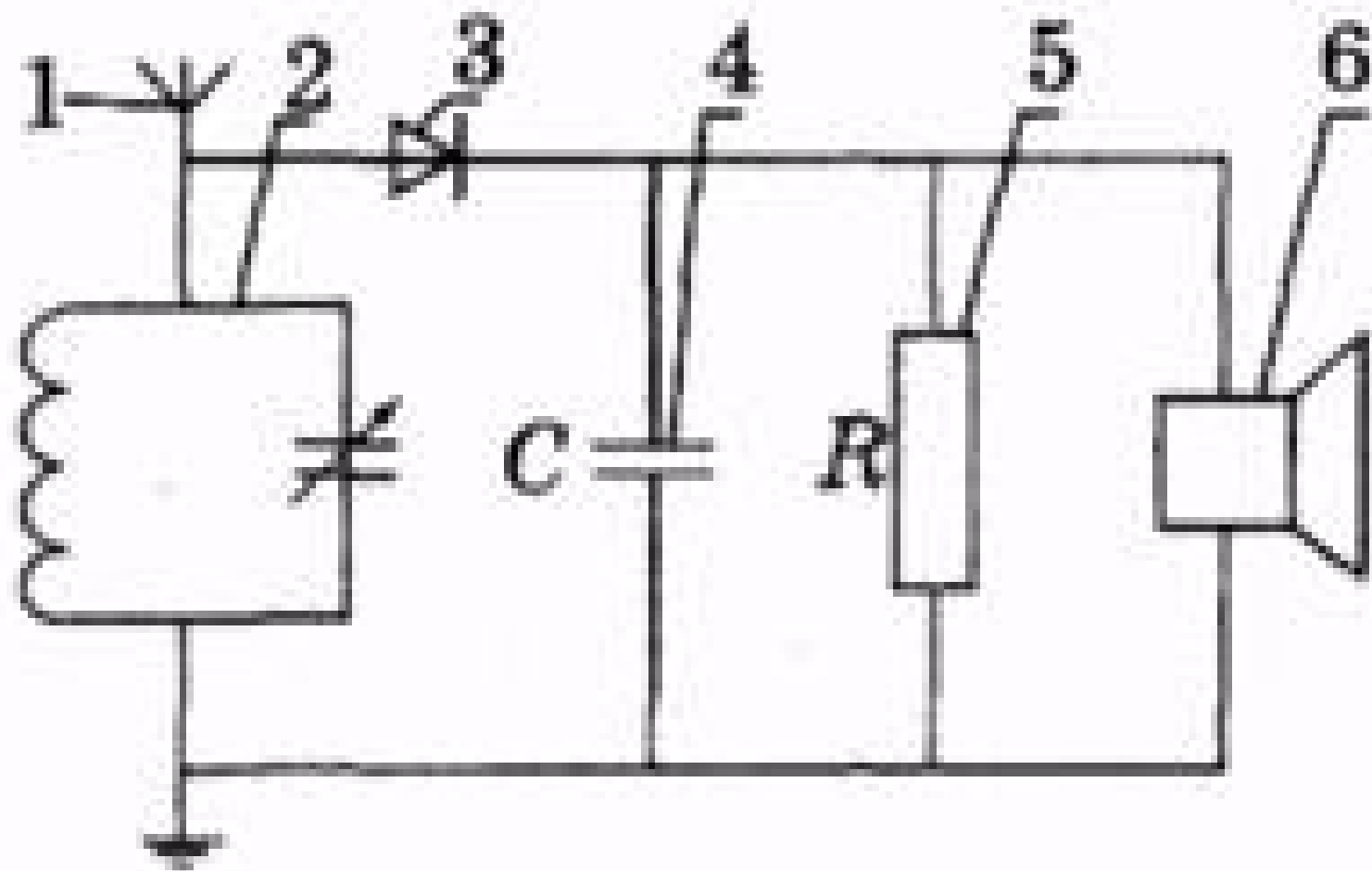

Мал. 2.180

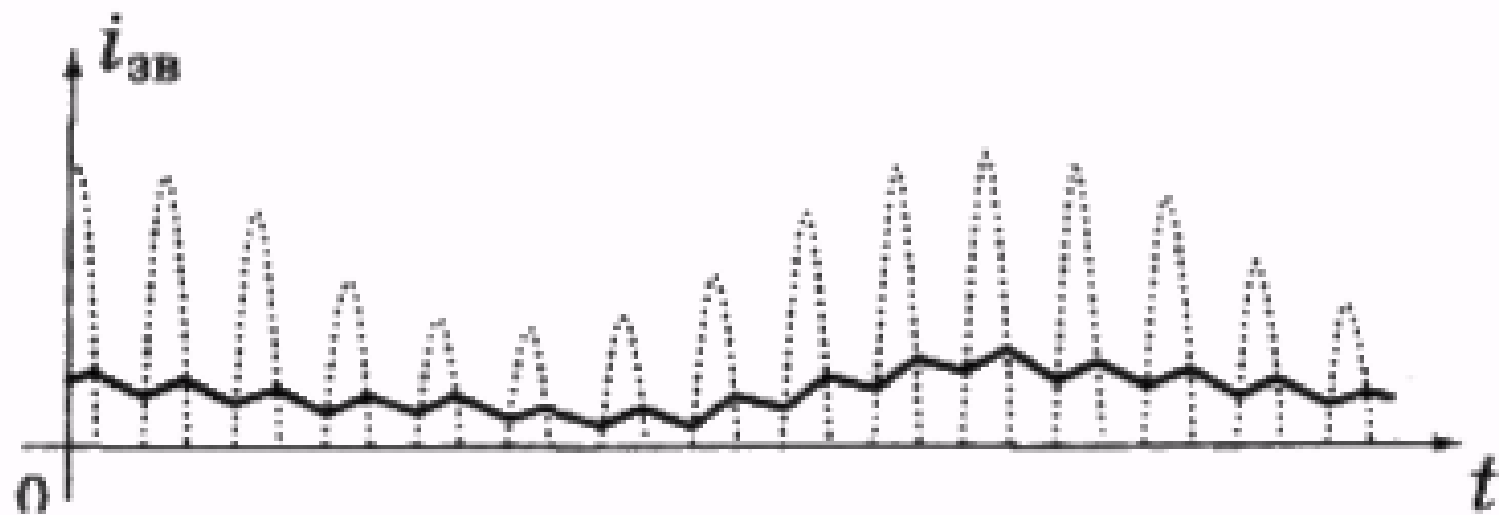

Мал. 2.182

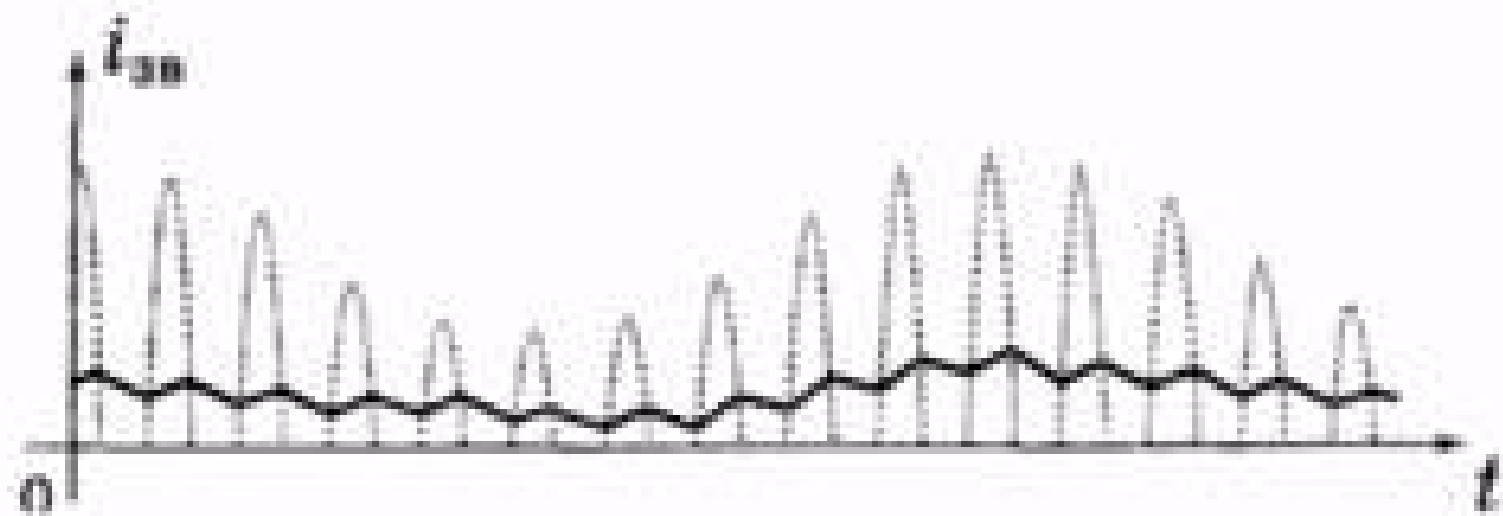

Мал. 2.182

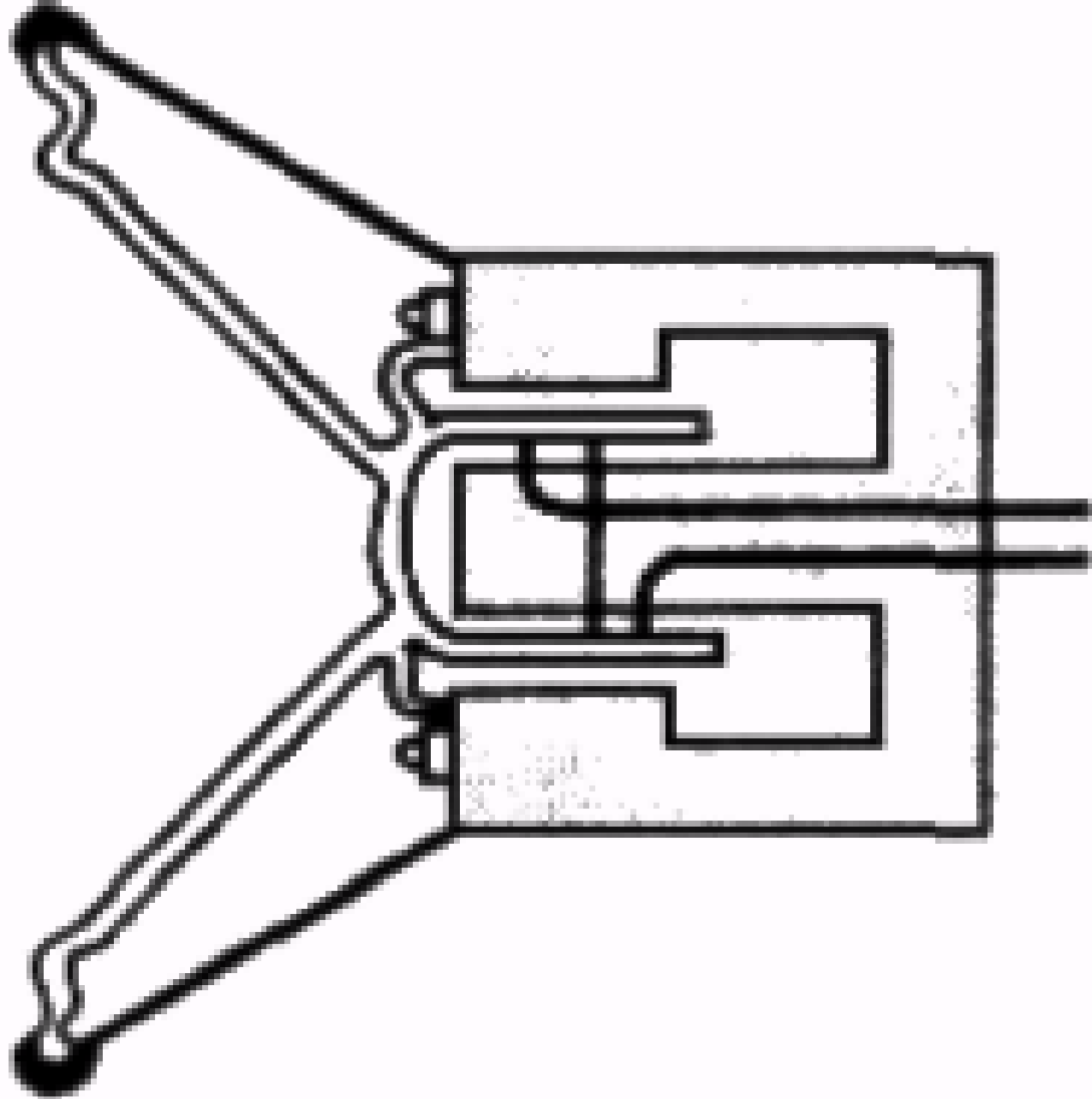

Мал. 2.183

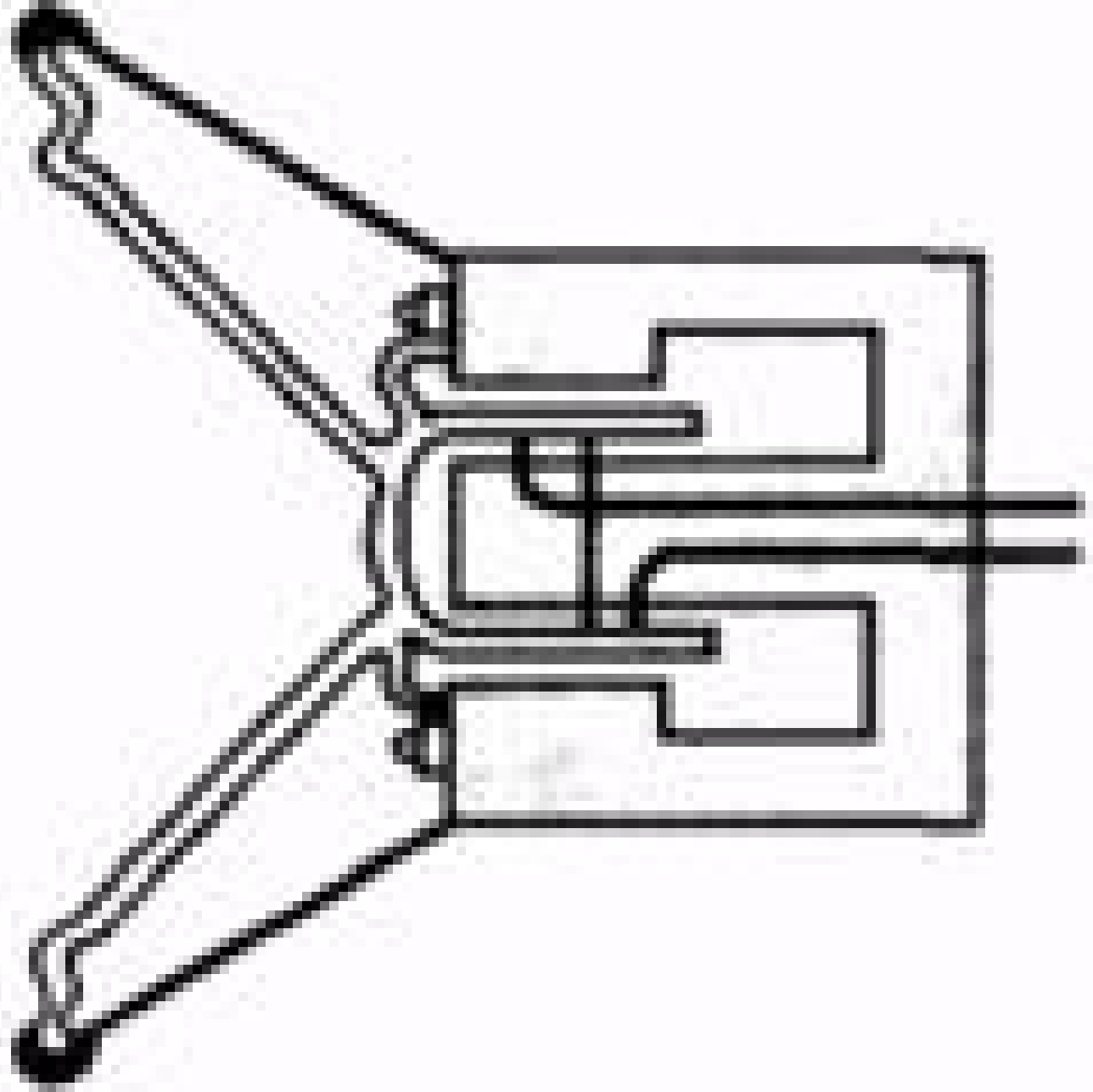

Mar. 2. 1883

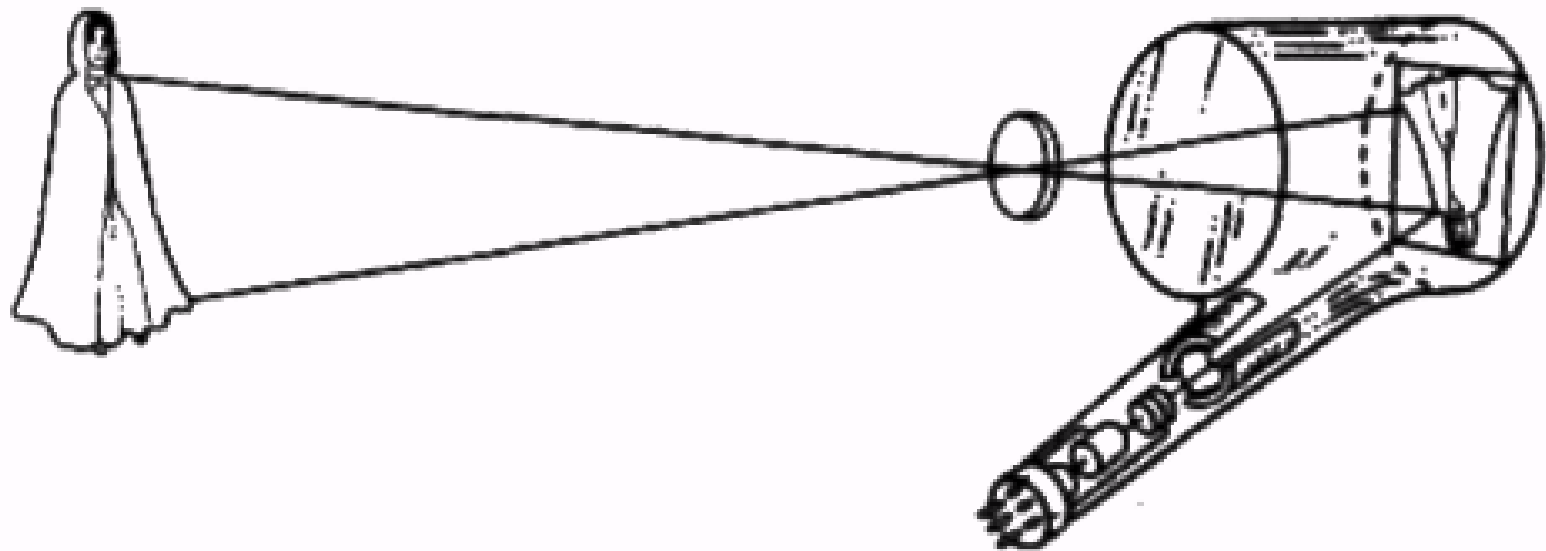

Мал. 2.184

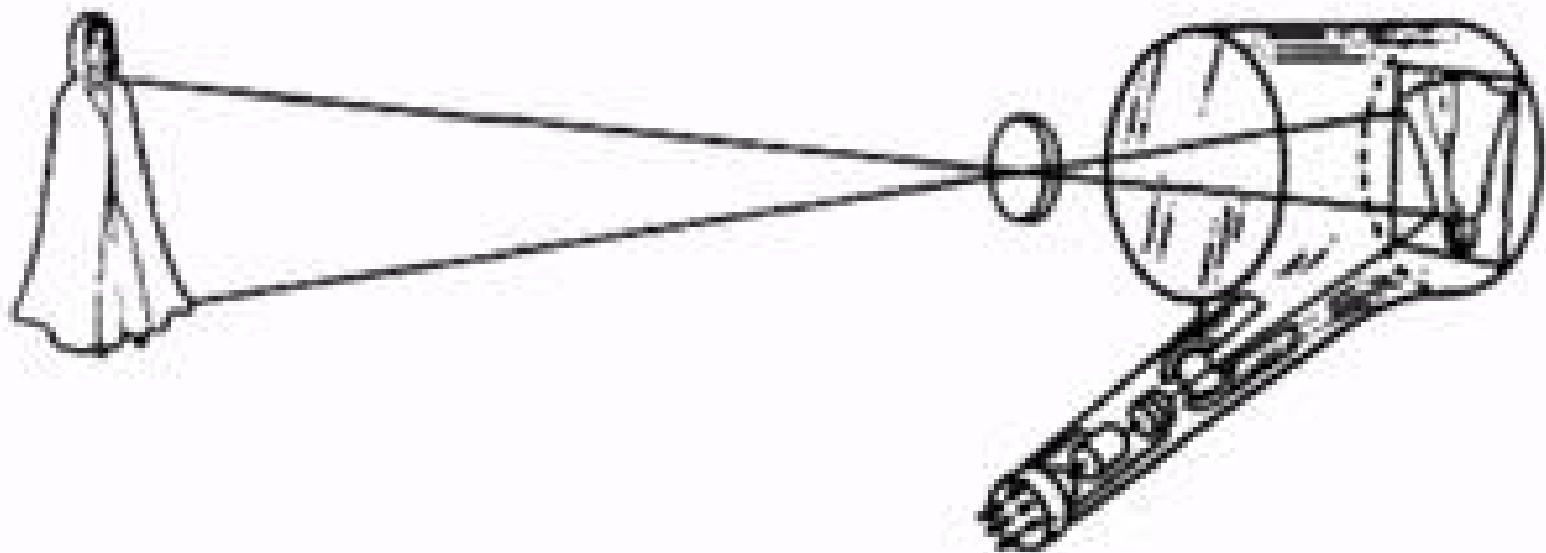

Мал. 2.184

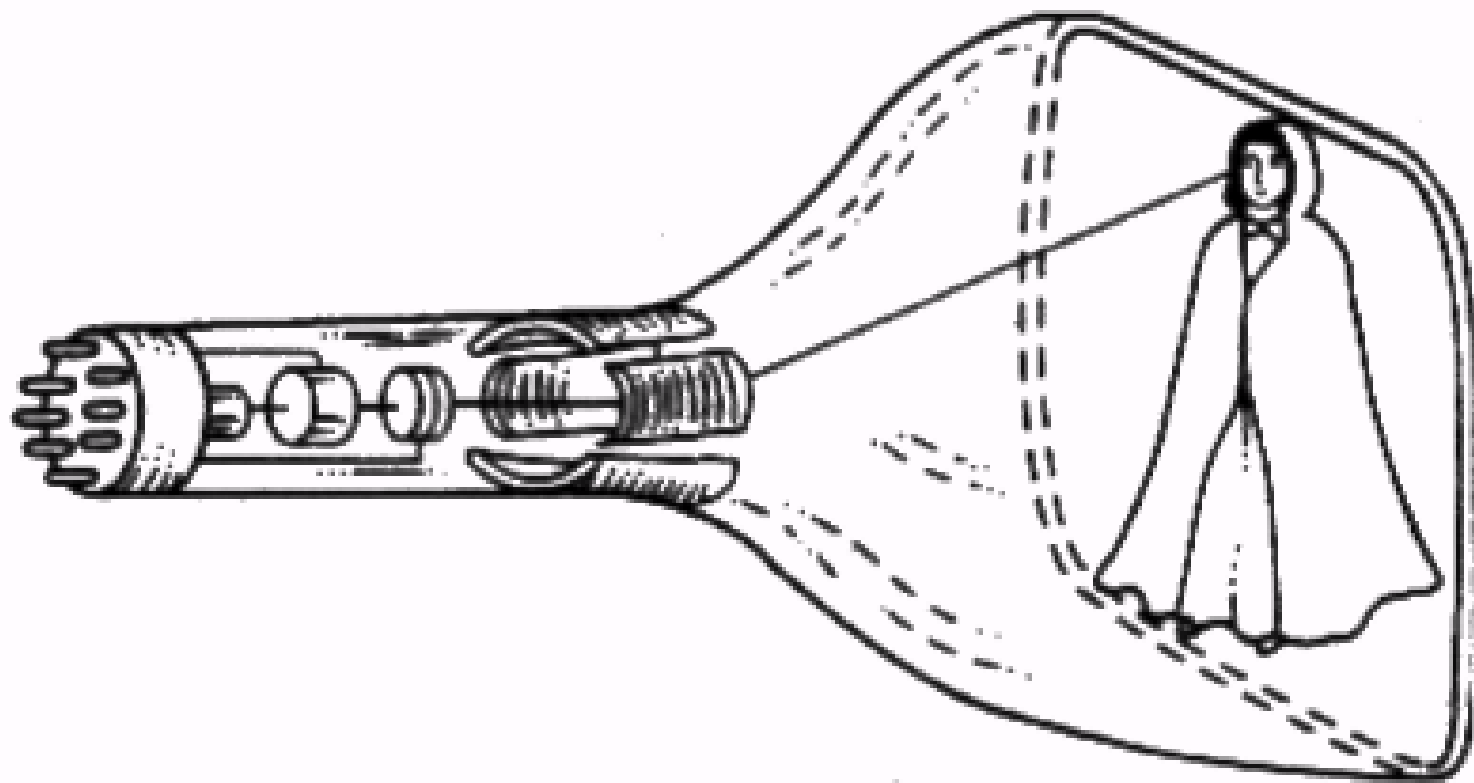

Мал. 2.185

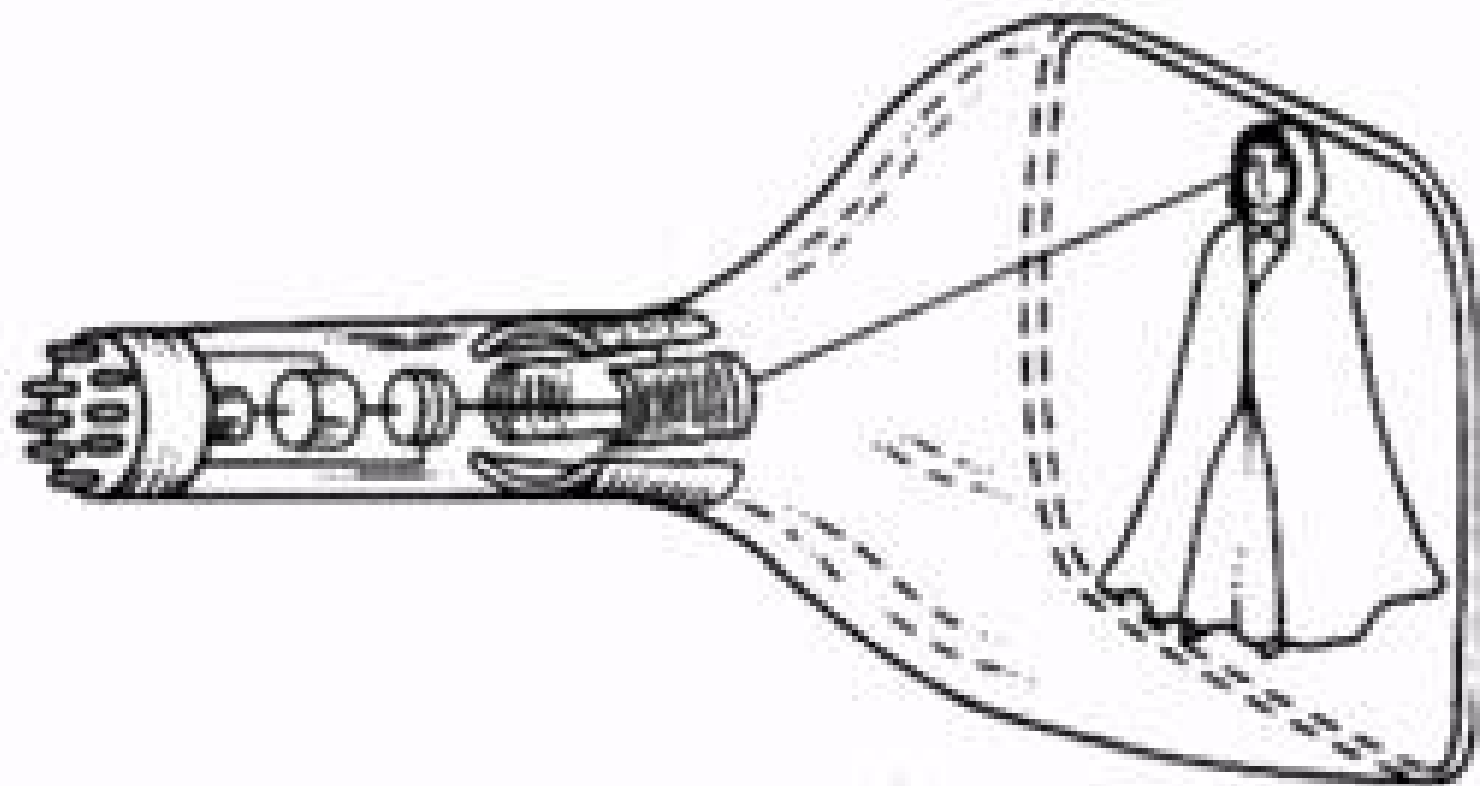

Мал. 2.185

1

=

ct

*

2

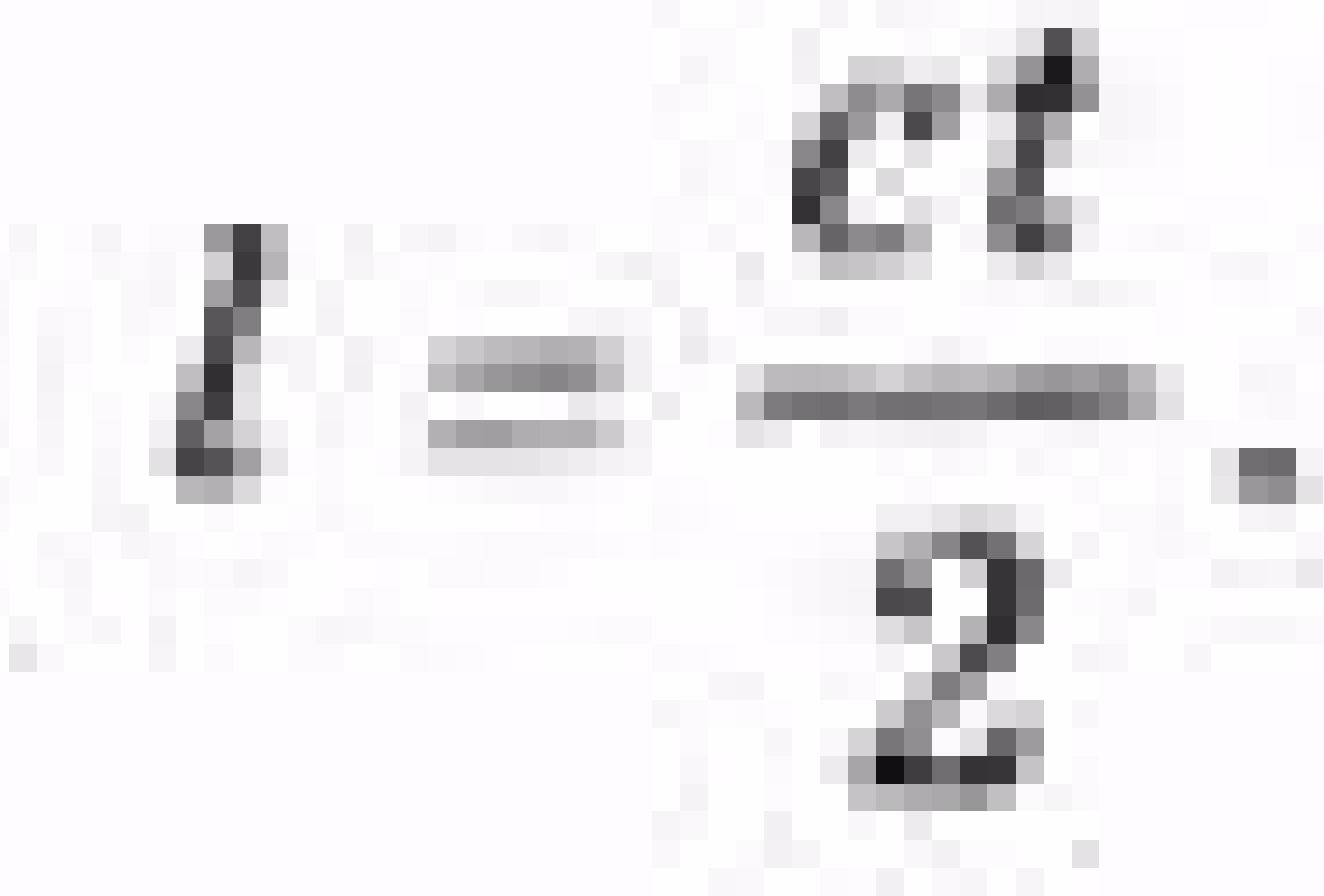



Мал. 2.186

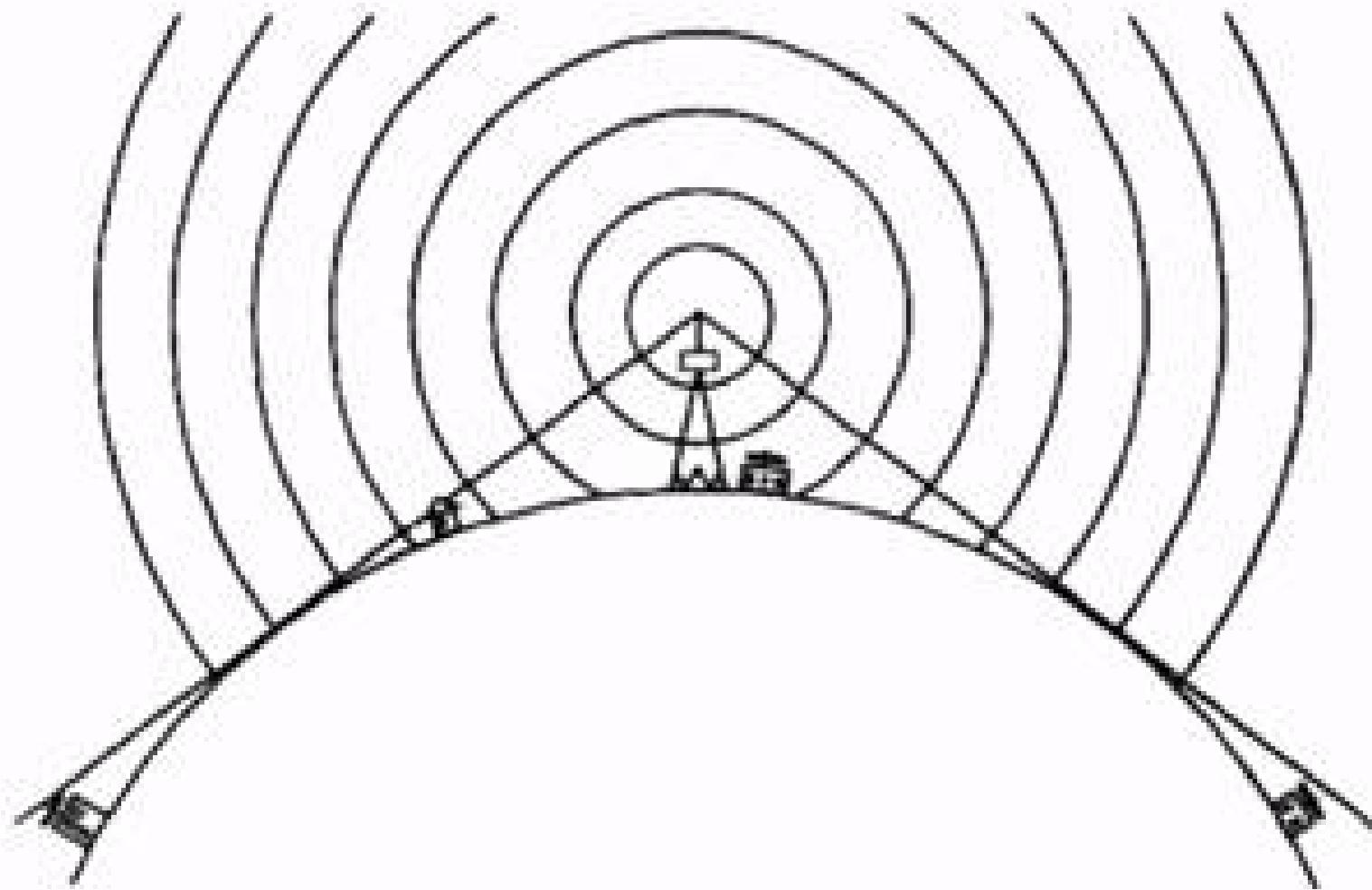

Мал. 2.186



Мал. 2.187



Мал. 2.187

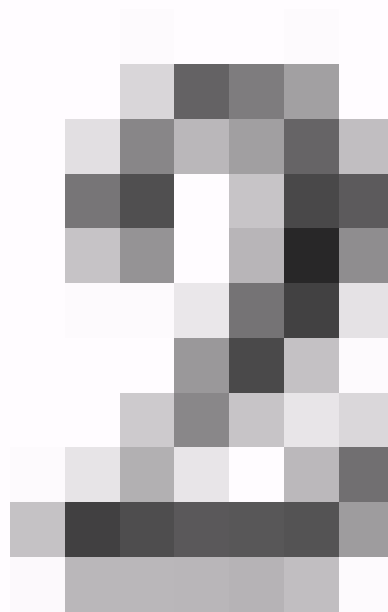
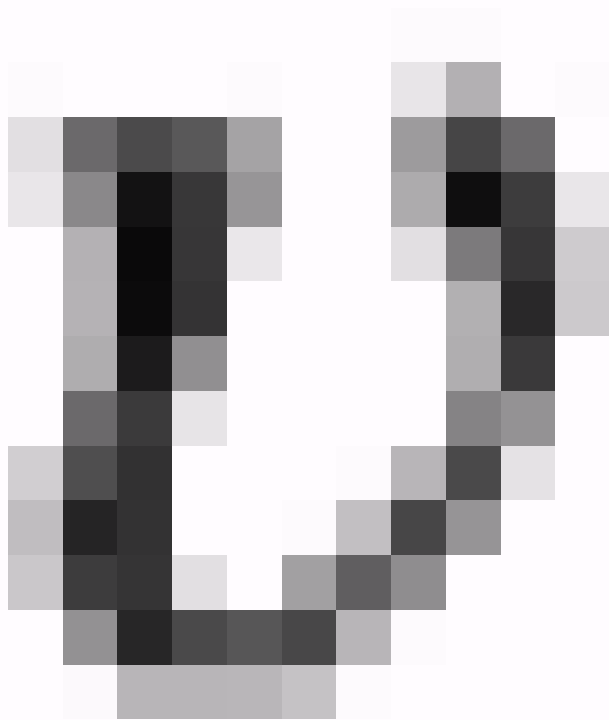



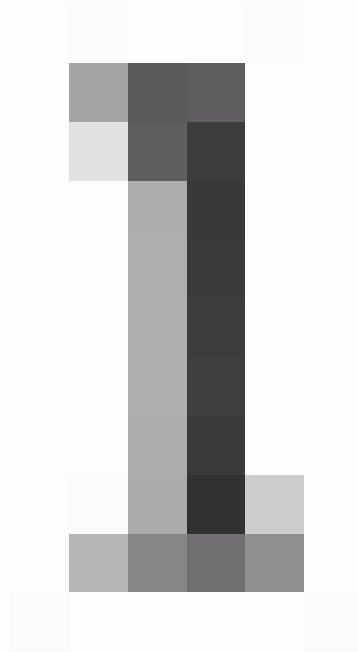
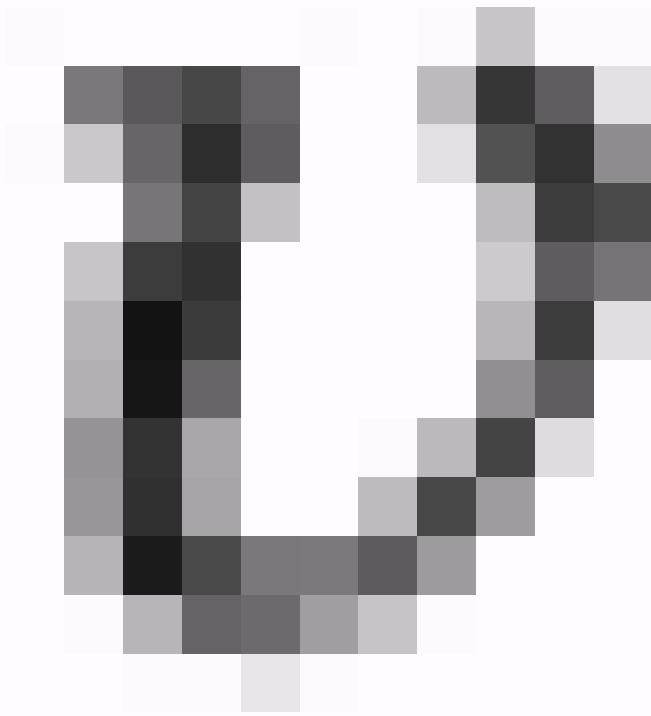



$$v = \frac{v_1 + v_2}{1 + \frac{v_1 v_2}{c^2}} \quad (54.1).$$

$$\frac{v_1 + v_2}{l + \frac{v_1 v_2}{c}}$$

$$(54.1)$$

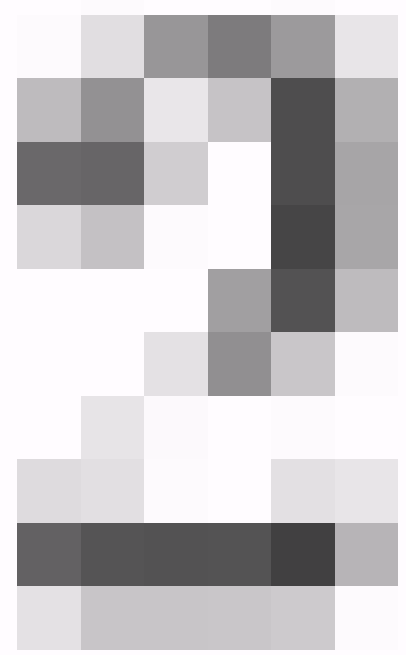
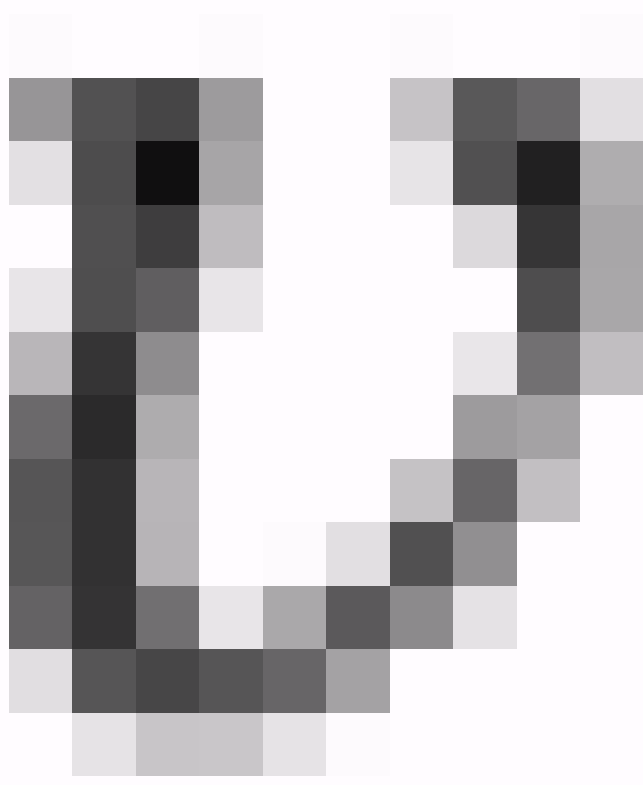



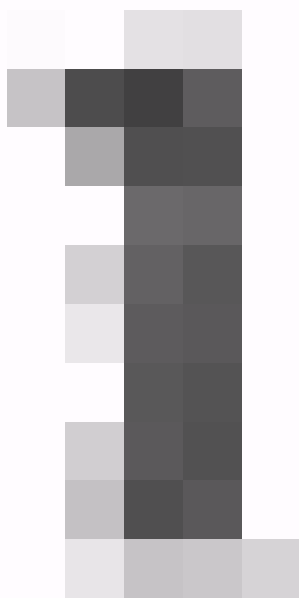
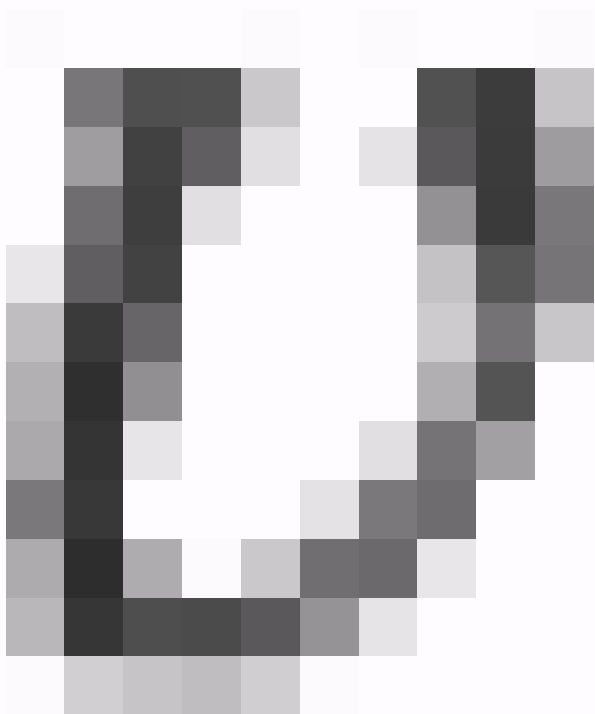

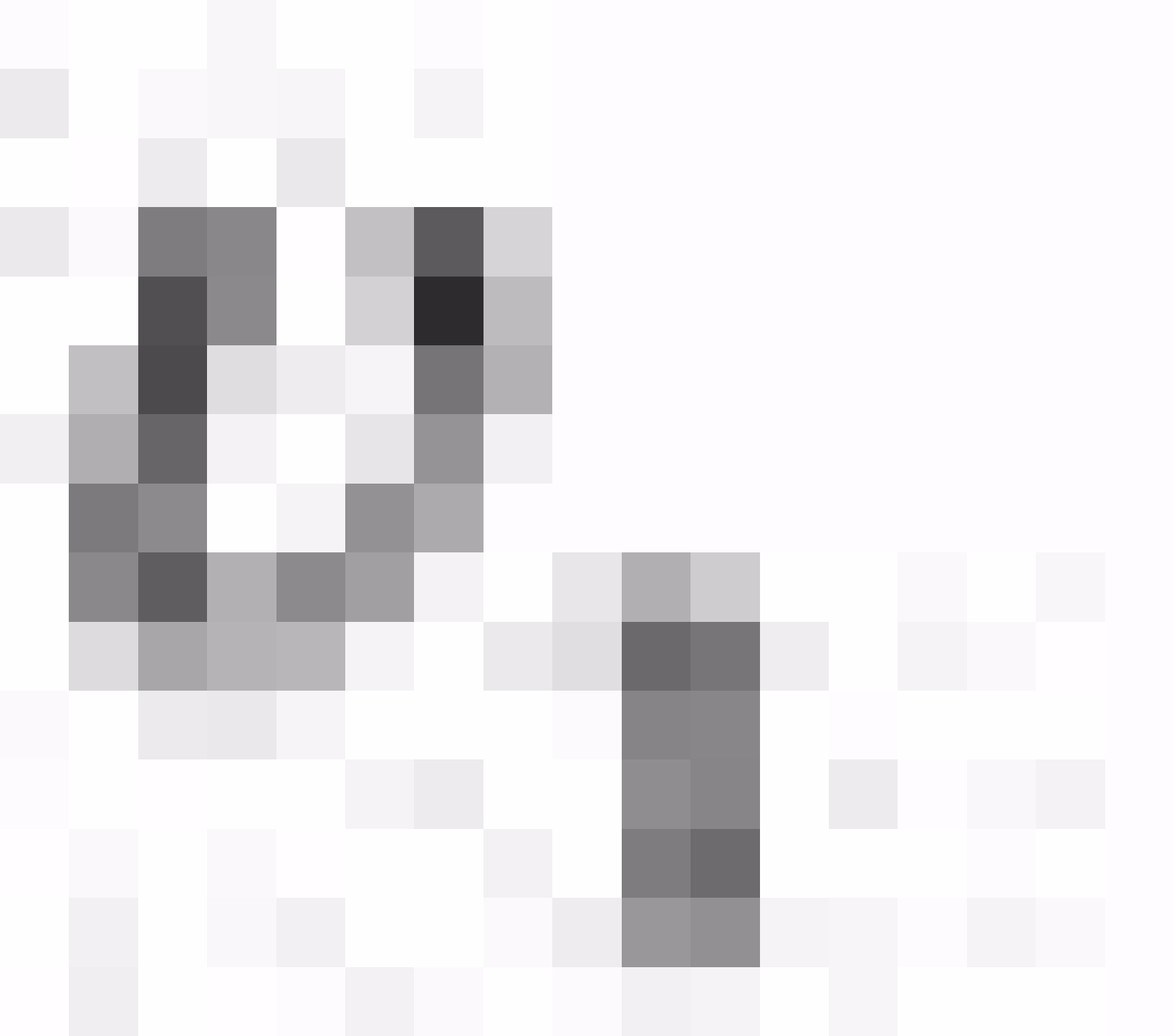

WORLD OF
WARRIORS



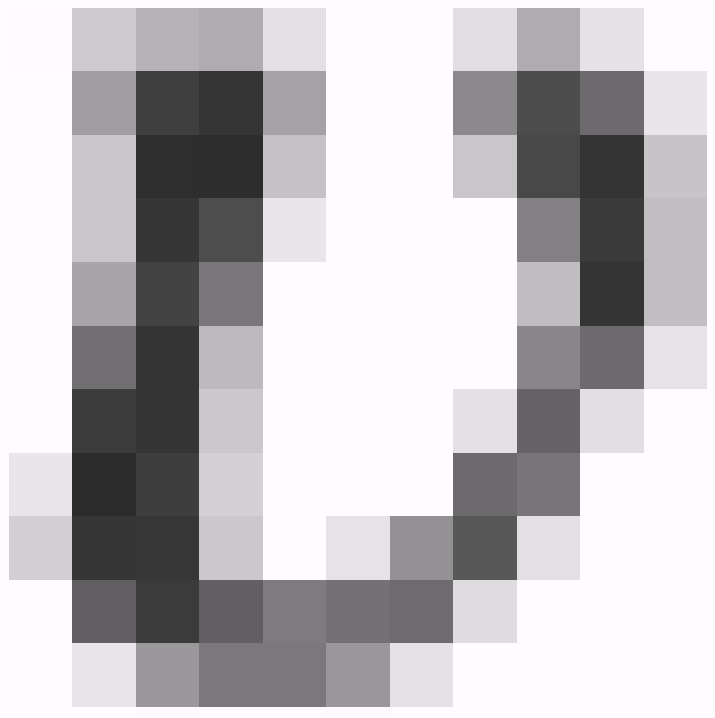
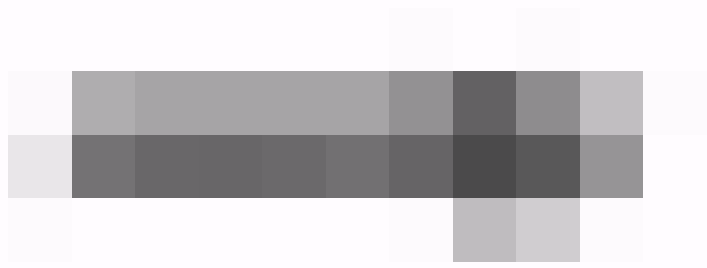

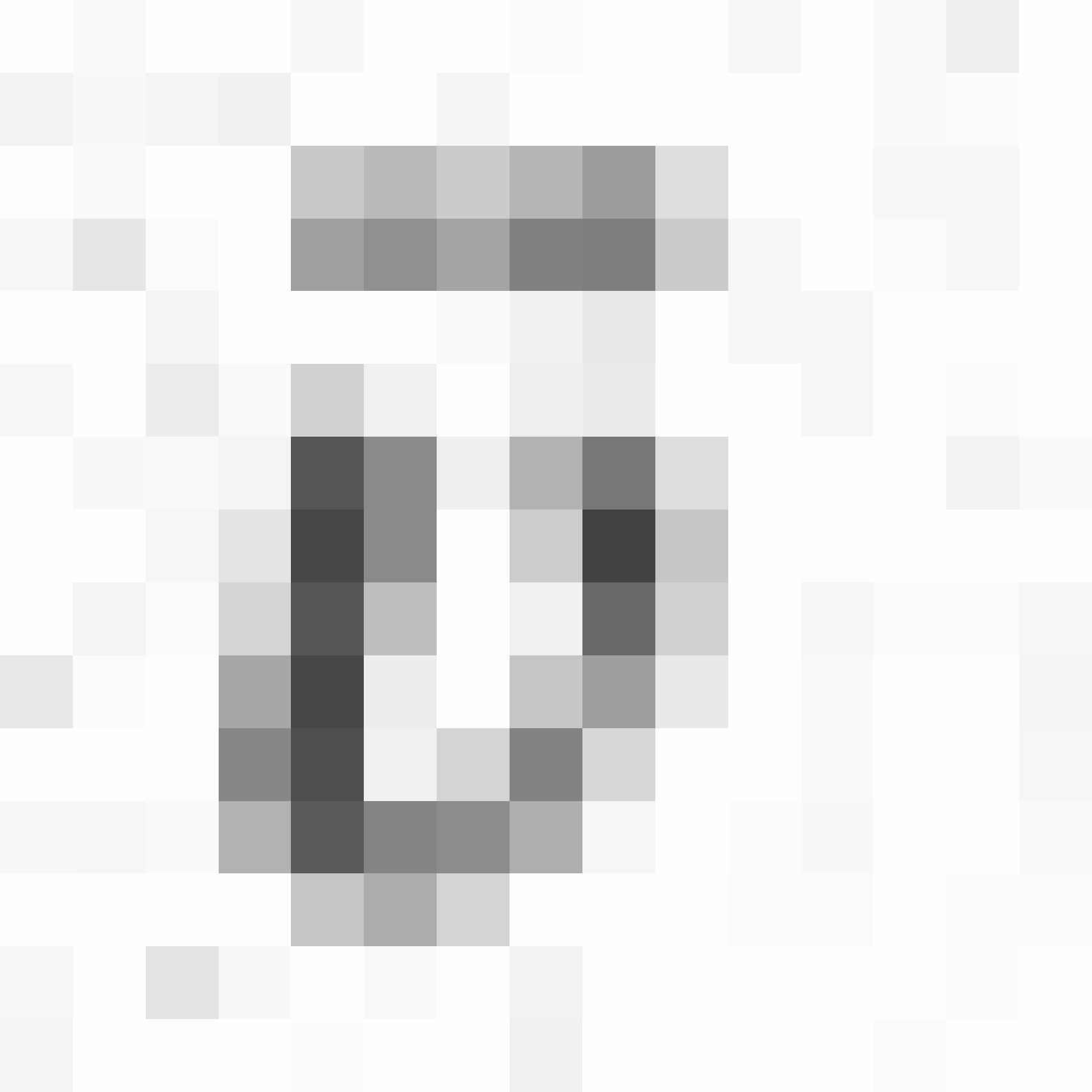

$$\vec{p} = \frac{m\vec{v}}{\sqrt{1 - \frac{v^2}{c^2}}} \quad (54.2).$$

$$\vec{p} = \frac{m\vec{v}}{\sqrt{1 - \frac{v^2}{c^2}}}$$

(54.21)

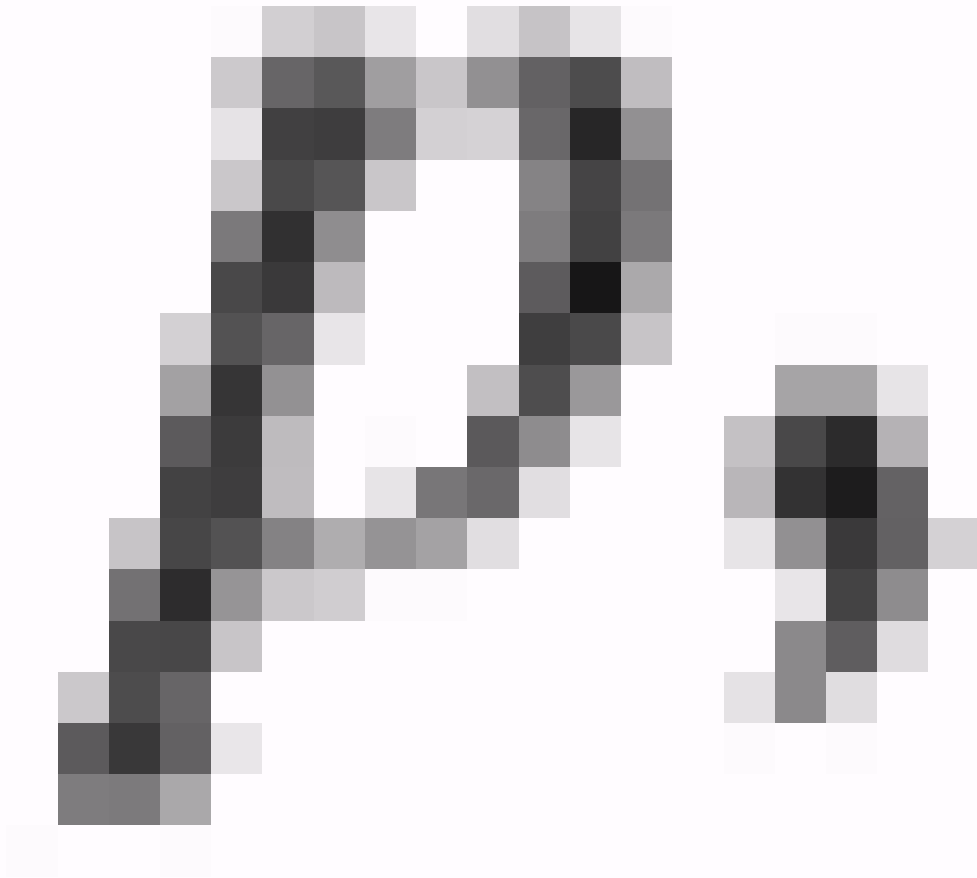



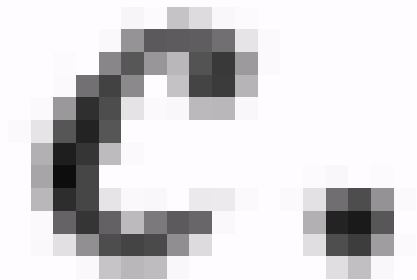
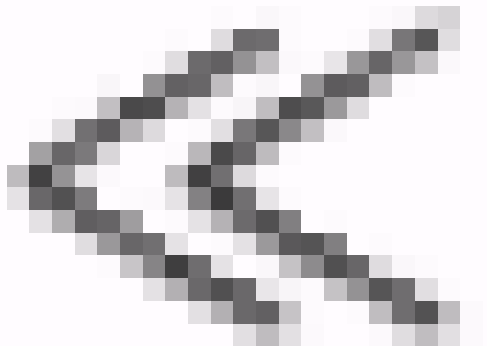
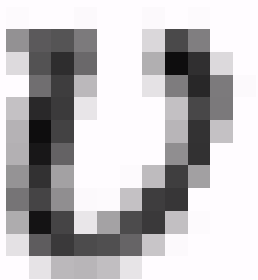

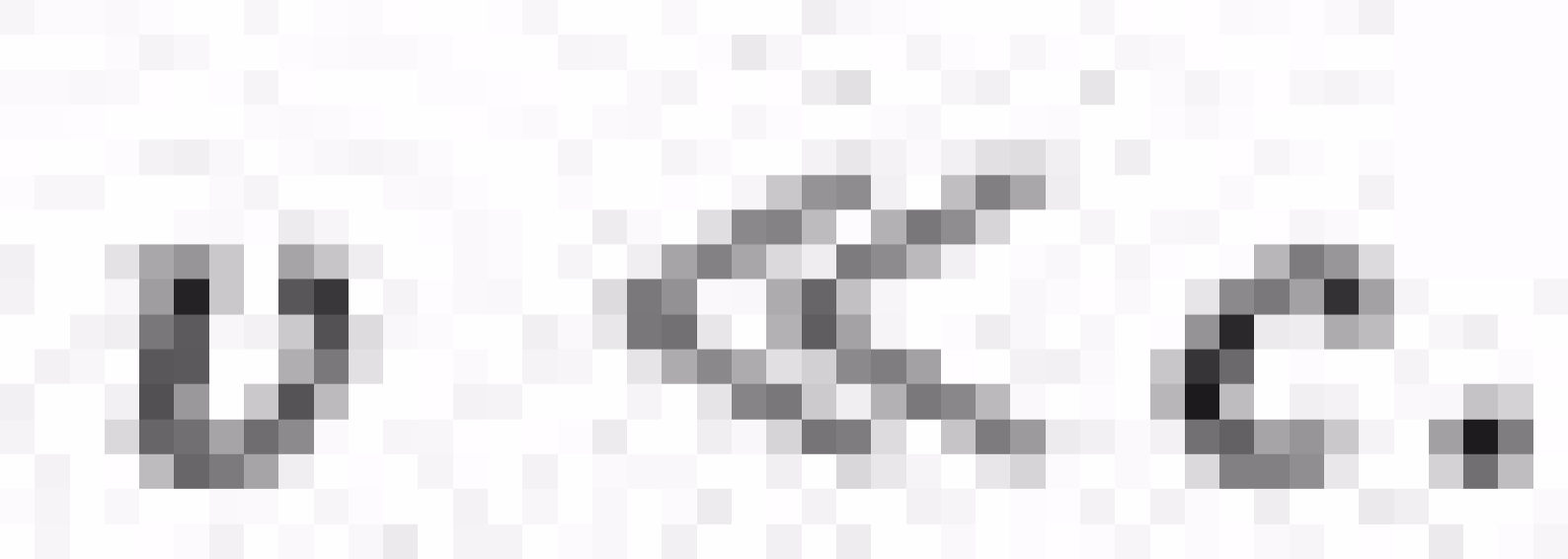

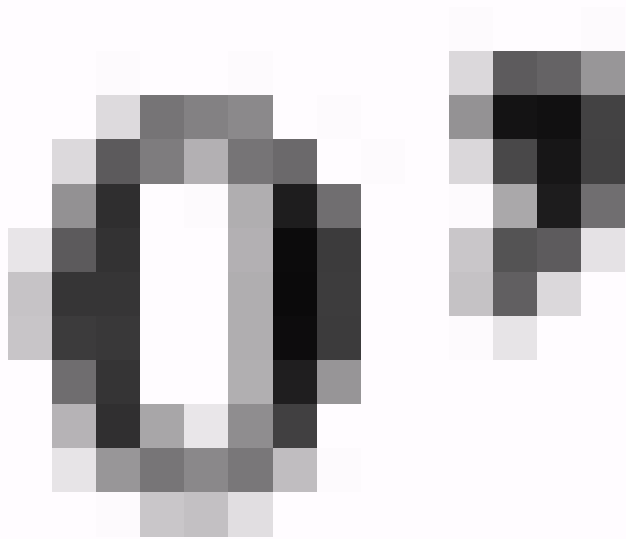
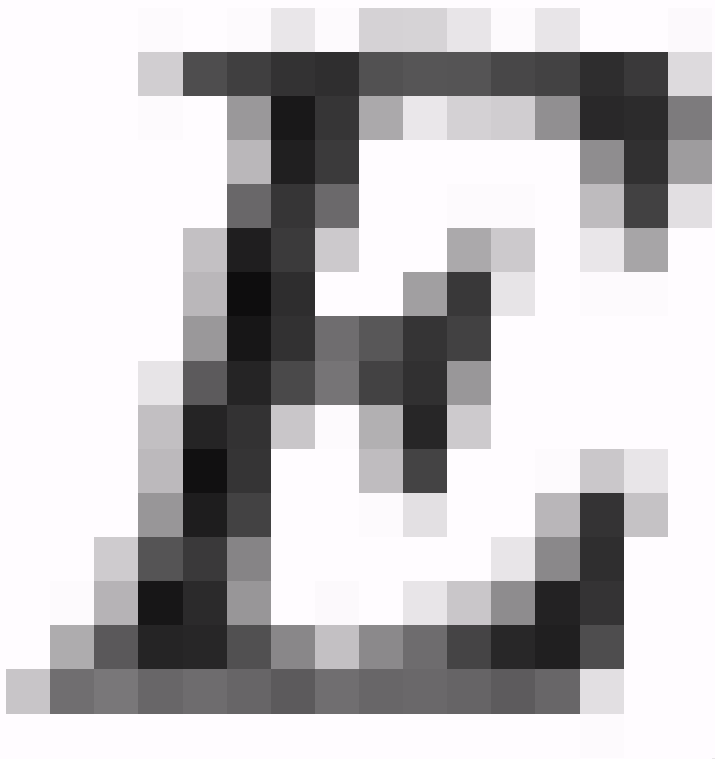

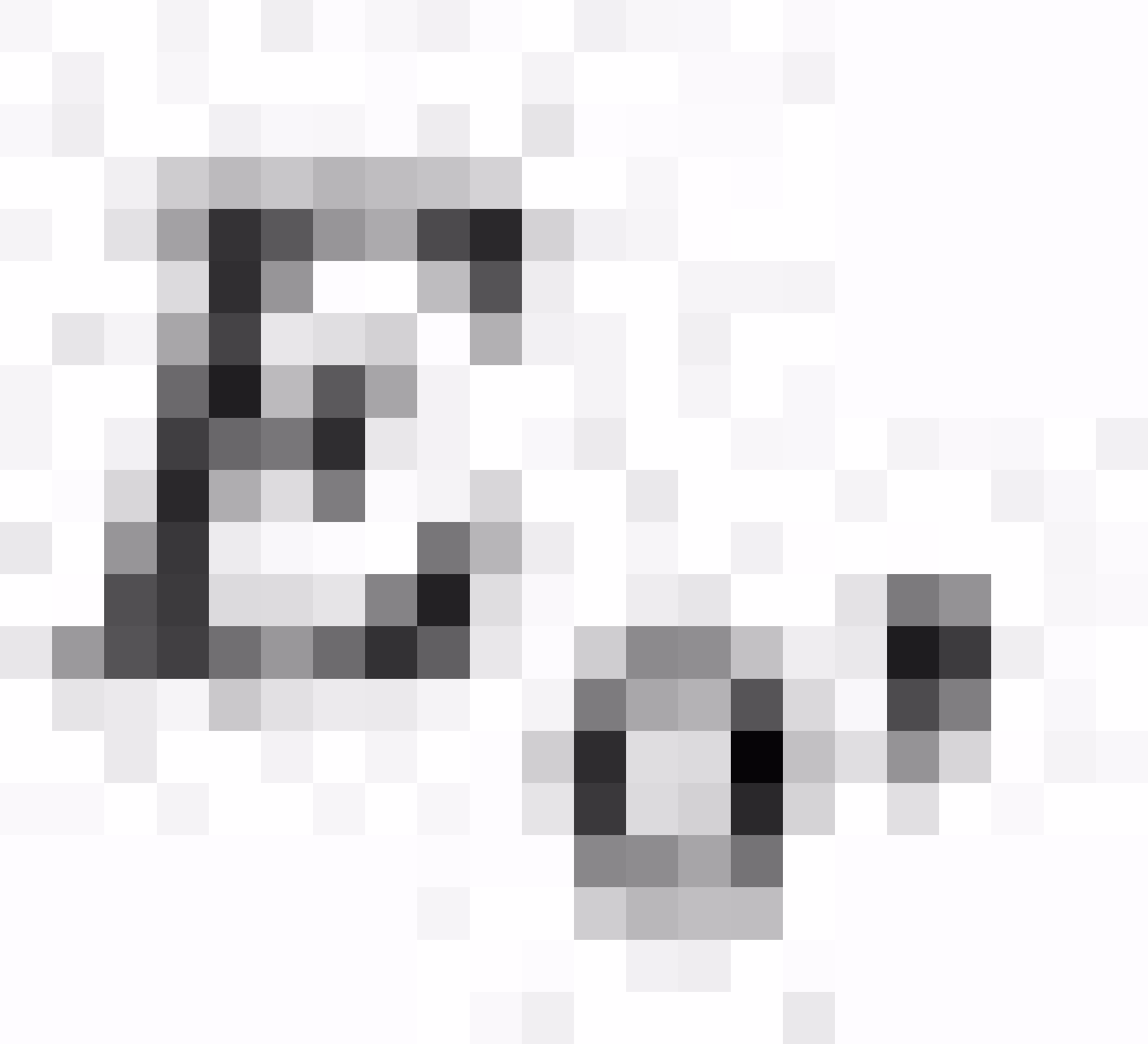

$$E_n = mc^2 (54.9)$$



$$E = \frac{mc^2}{\sqrt{1 - \frac{v^2}{c^2}}} \quad (54.4).$$

$$E = \frac{mc^2}{\sqrt{1 - \frac{v^2}{c^2}}}$$

(54.4).

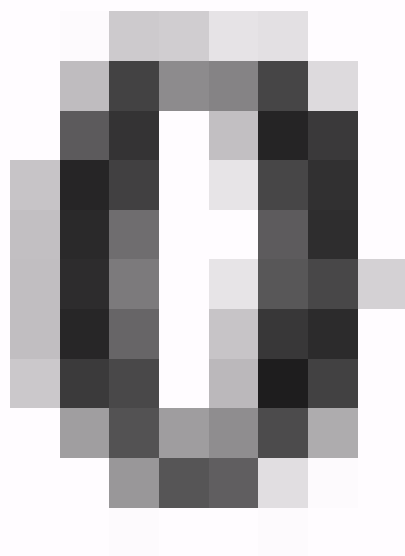
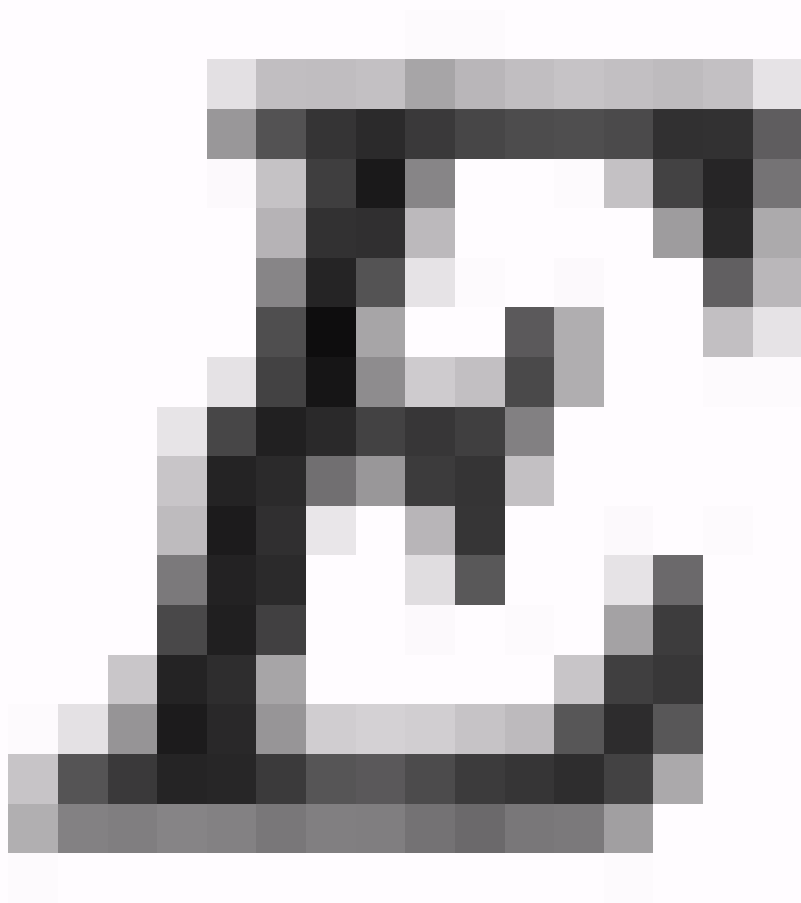

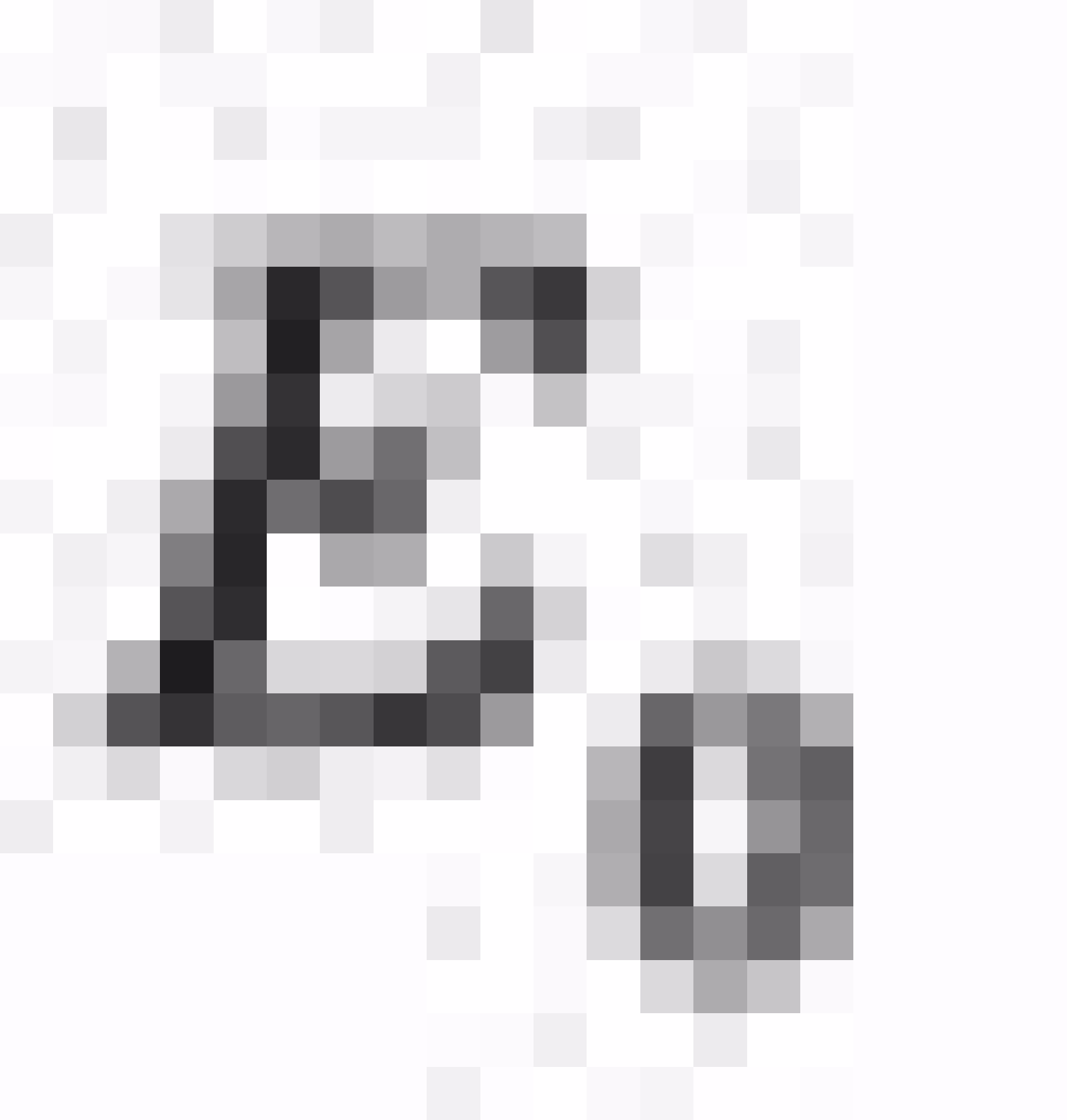

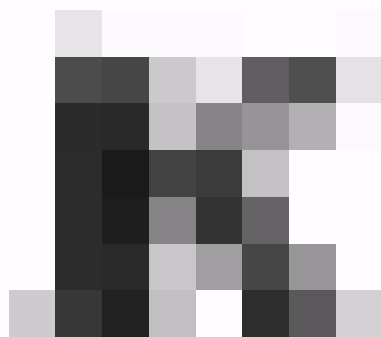
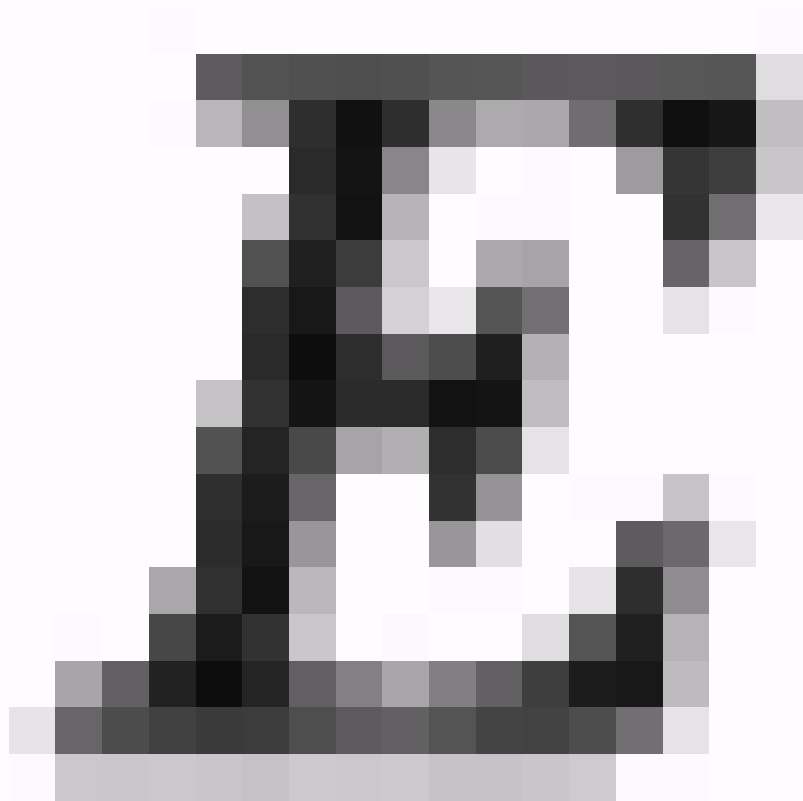

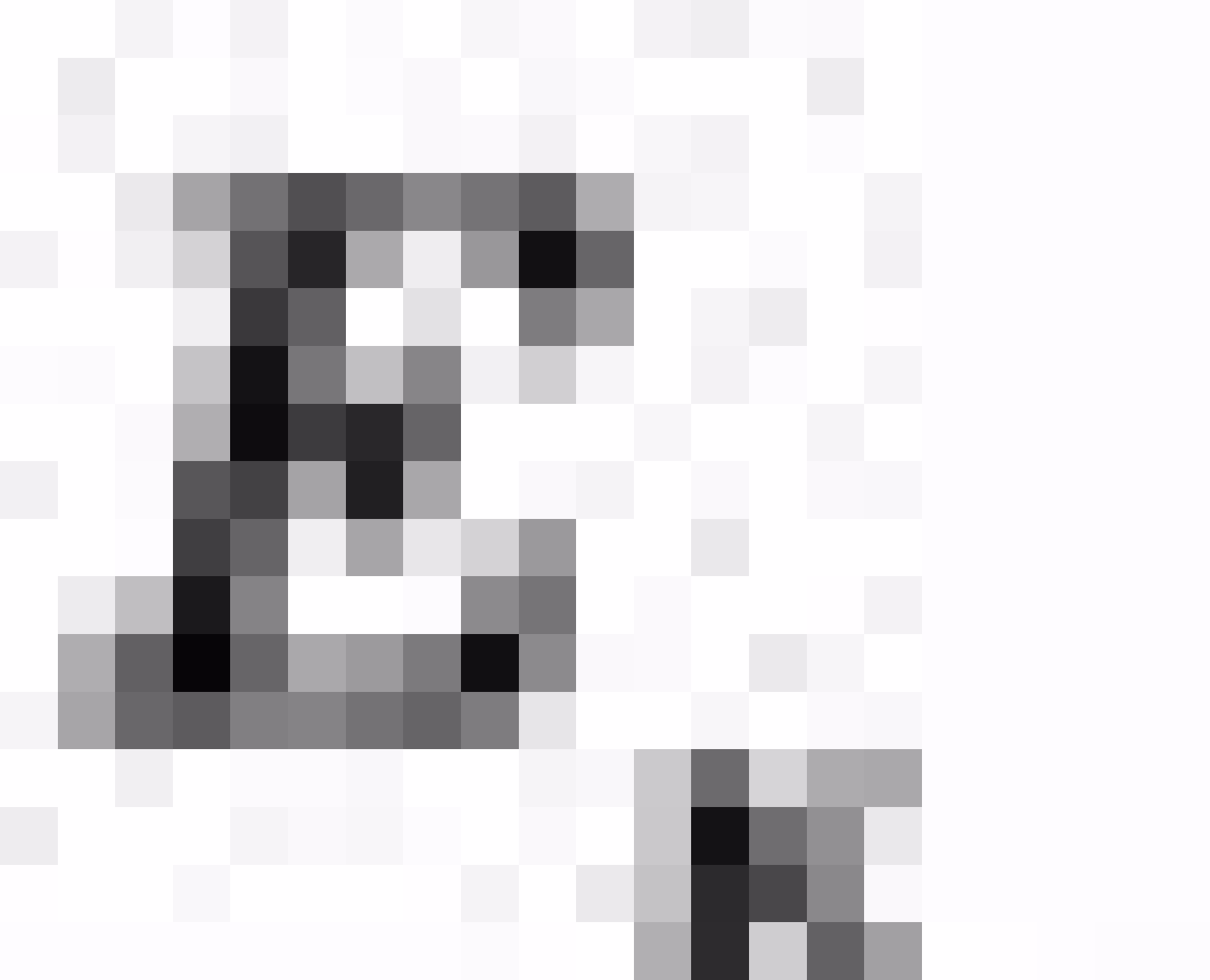

$E = E - E_0$

(54.5)



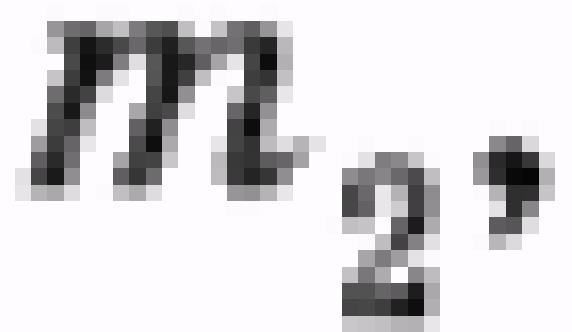
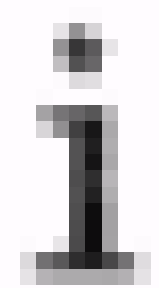
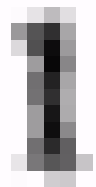
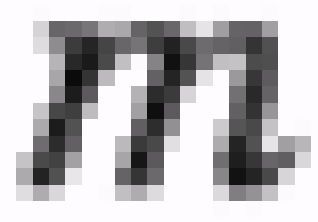



10

i

10



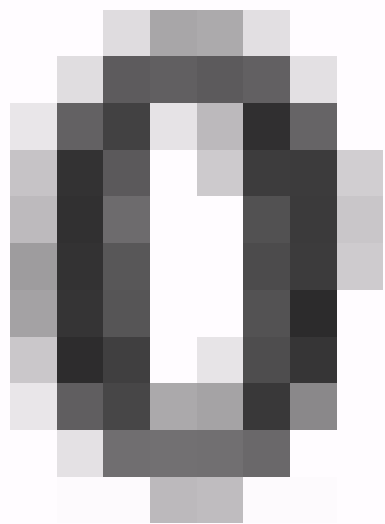
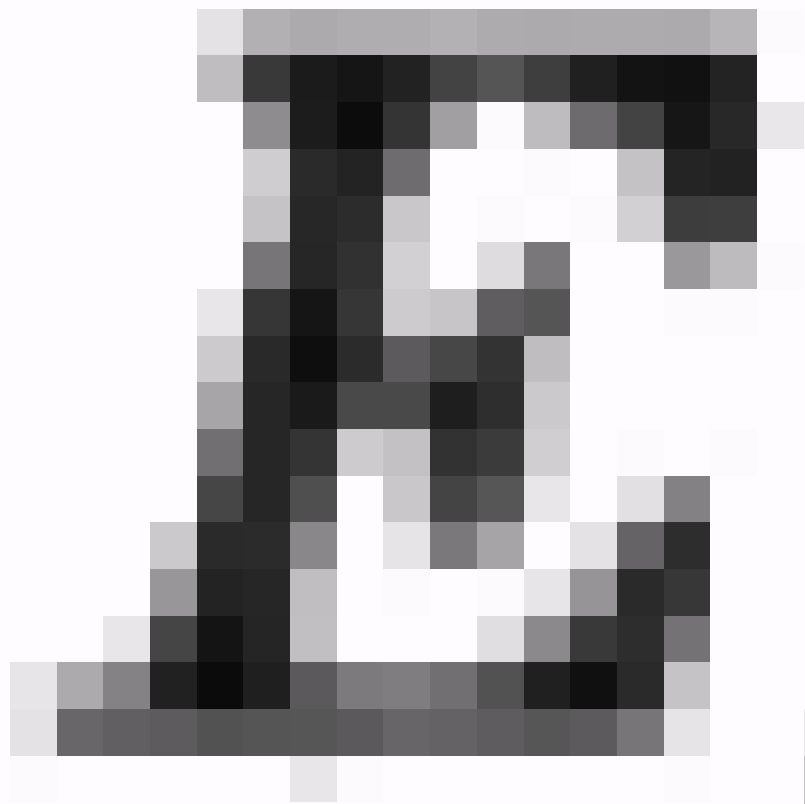

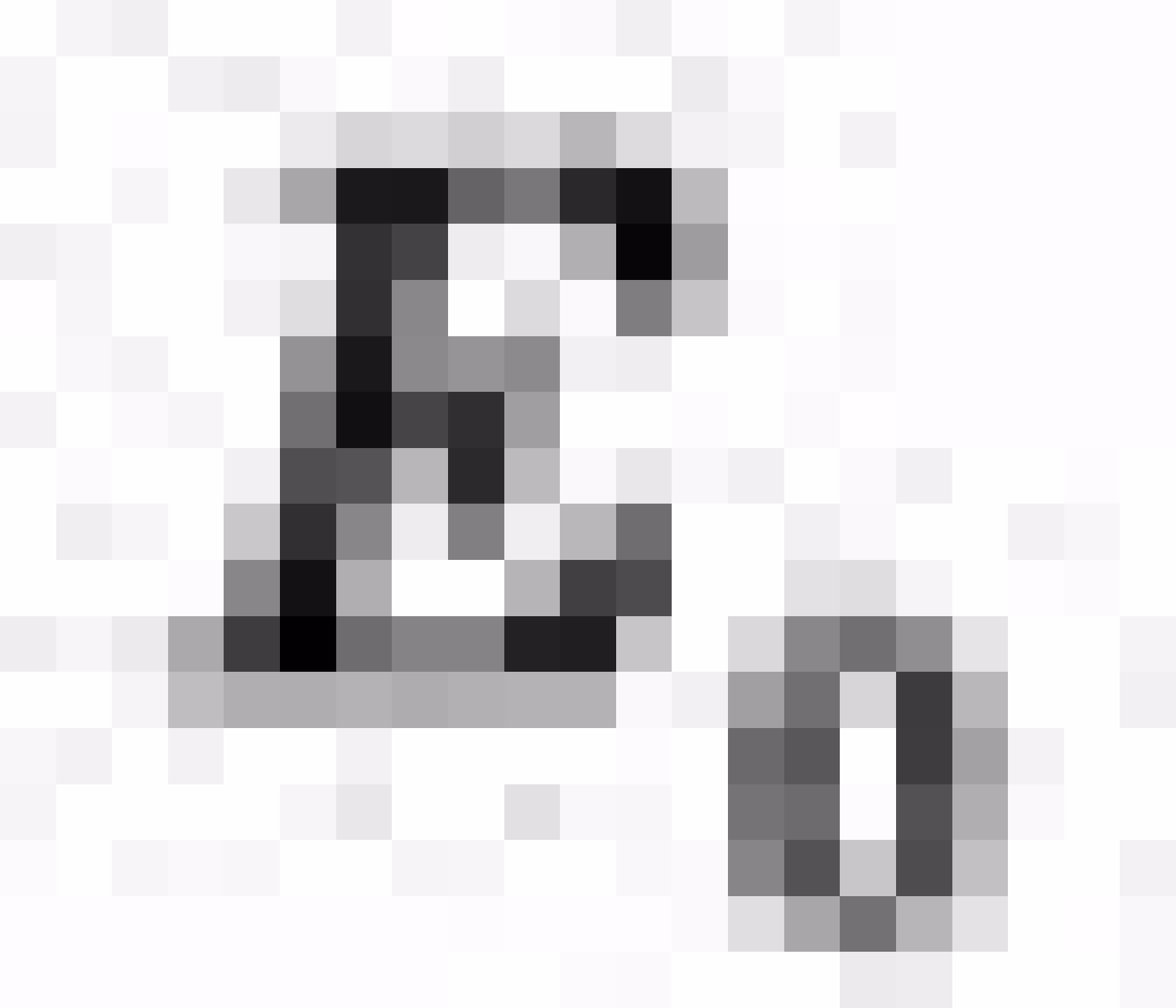

$$E_0 = E_{0_1} + E_{0_2} + W \quad (54.6)$$

1917

1918

1919

1920

1921

$$\frac{E_0}{c^2} = \frac{E_{0_1}}{c^2} + \frac{E_{0_2}}{c^2} + \frac{W}{c^2} \quad (54.7),$$

$$M = m_1 + m_2 + \frac{W}{c^2} \quad (54.8).$$

$$\frac{E_0}{c^2} = \frac{E_{01}}{c^2} + \frac{E_{02}}{c^2} + \frac{W}{c^2} \quad (54.7).$$

$$M = m_1 + m_2 + \frac{W}{c^2} \quad (54.8).$$

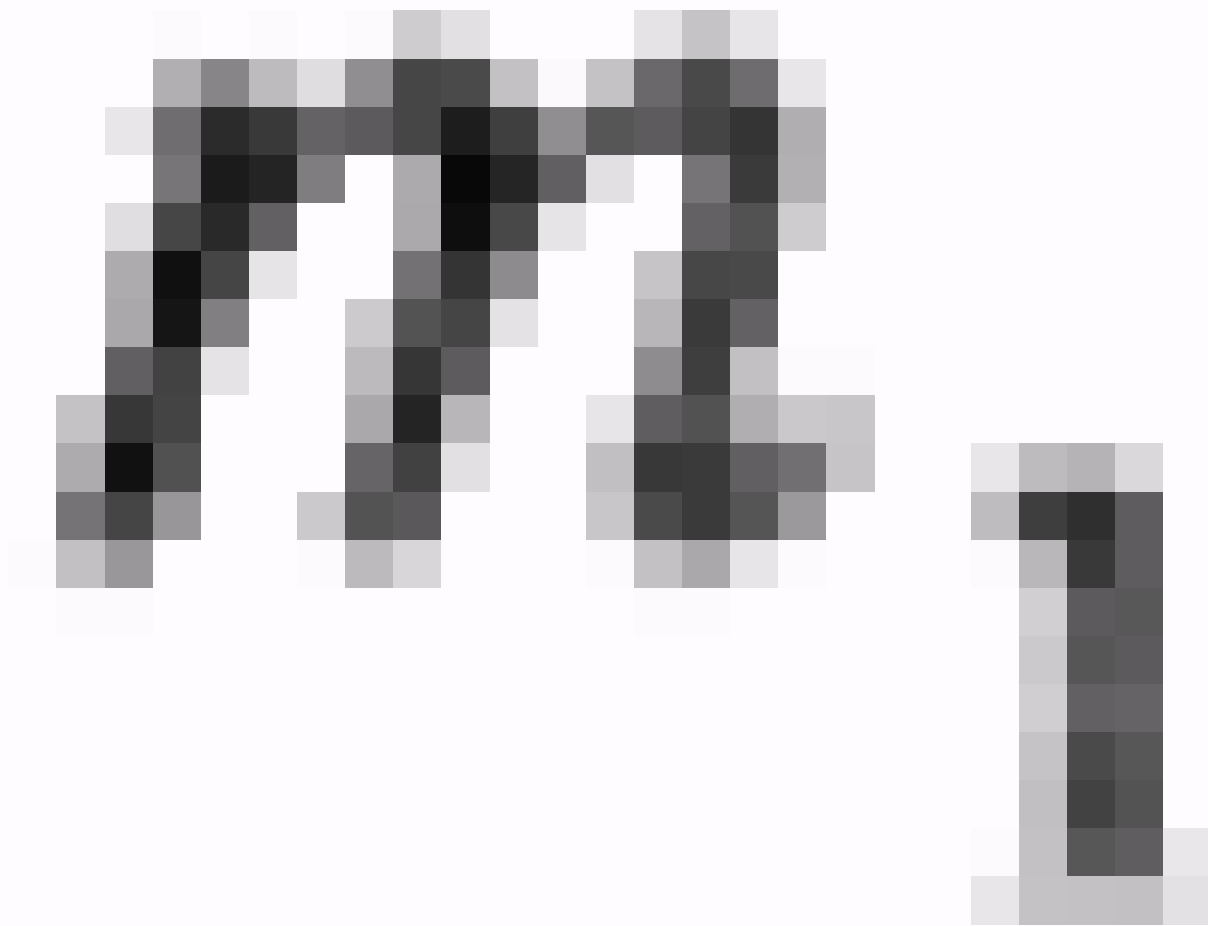



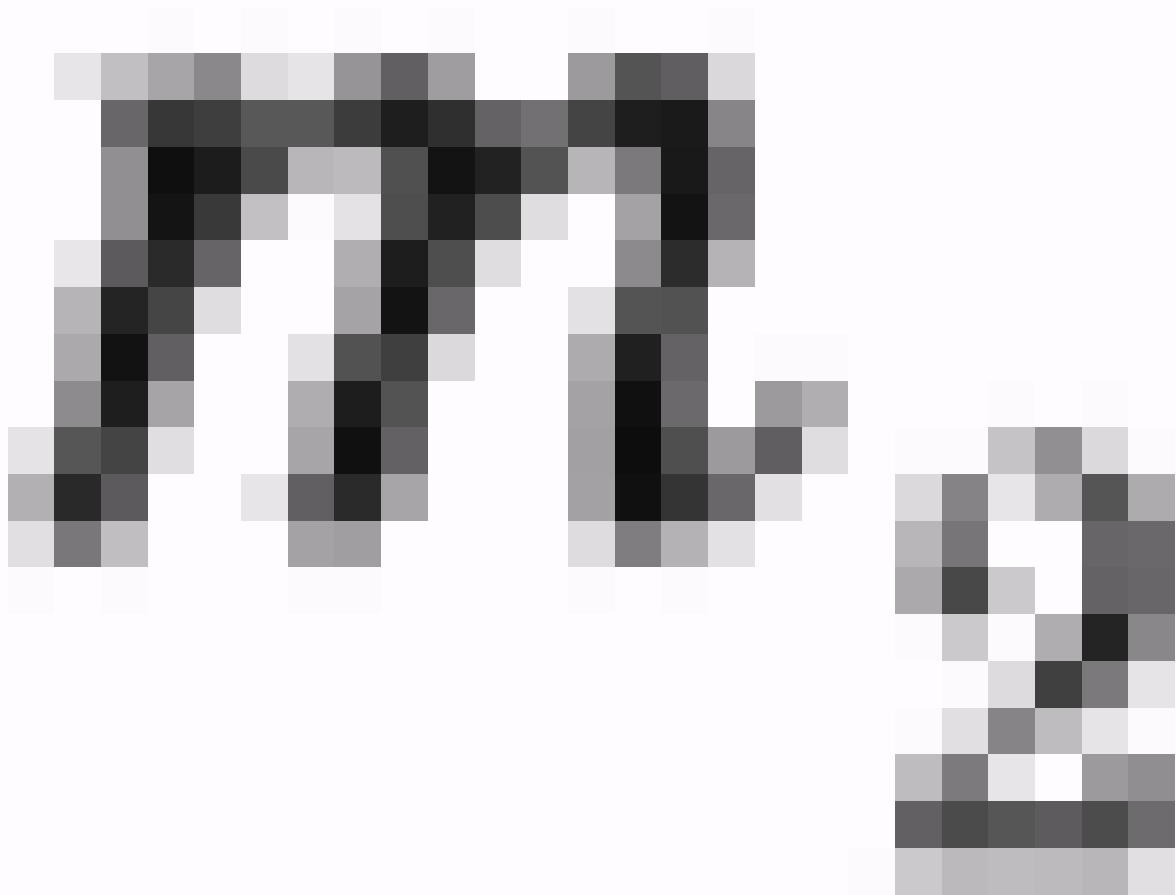





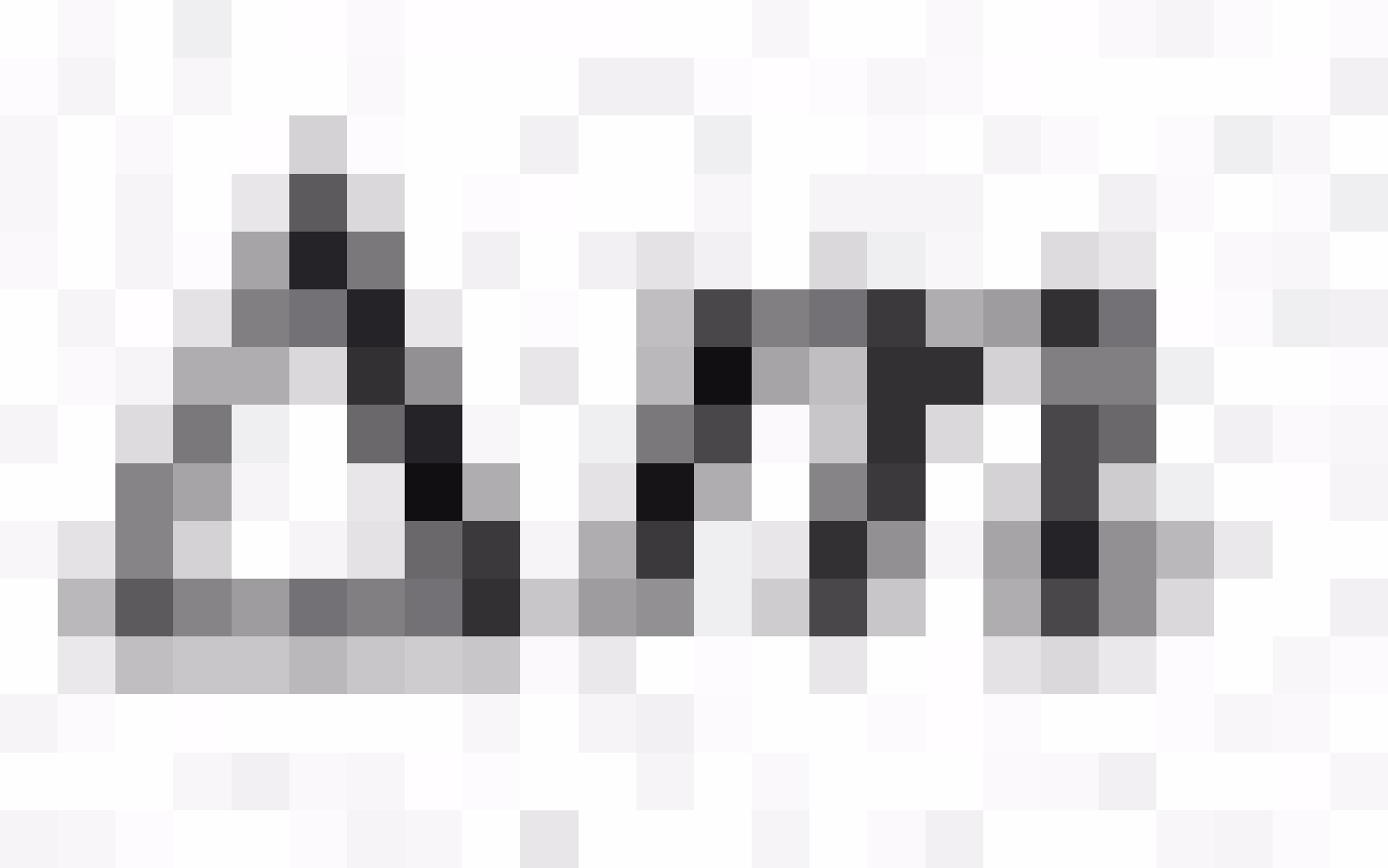

$$\Delta m = m_1 + m_2 - M = -\frac{W}{c^2} \quad (54.9).$$



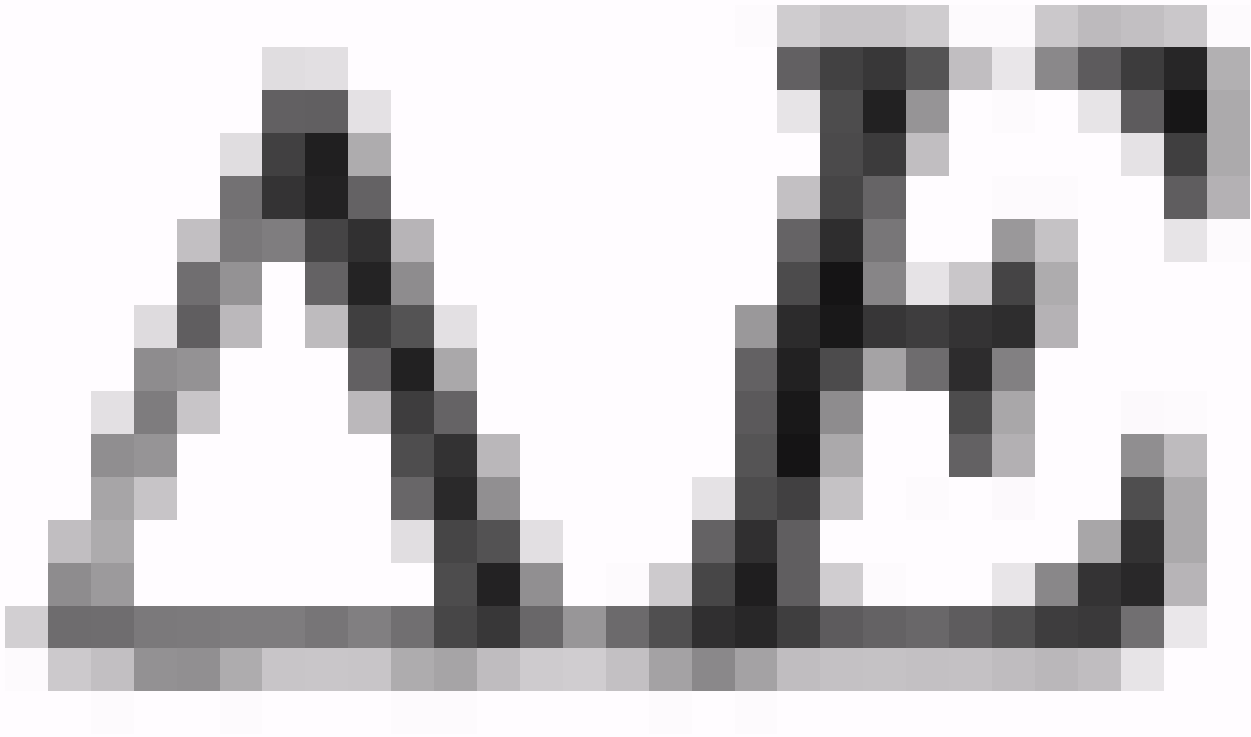



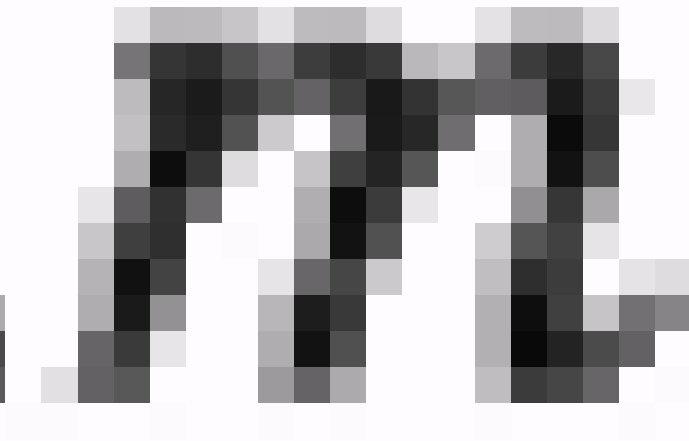
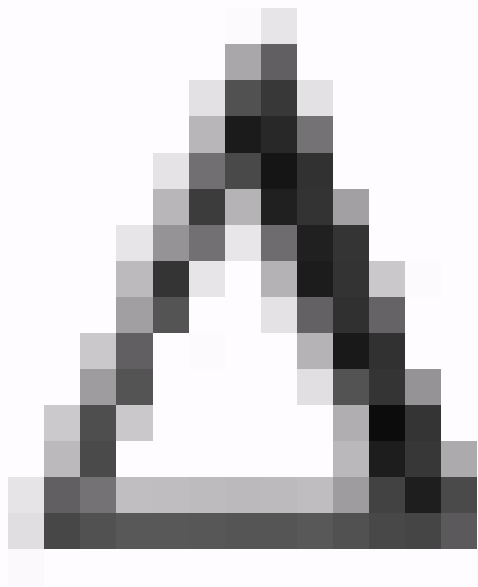

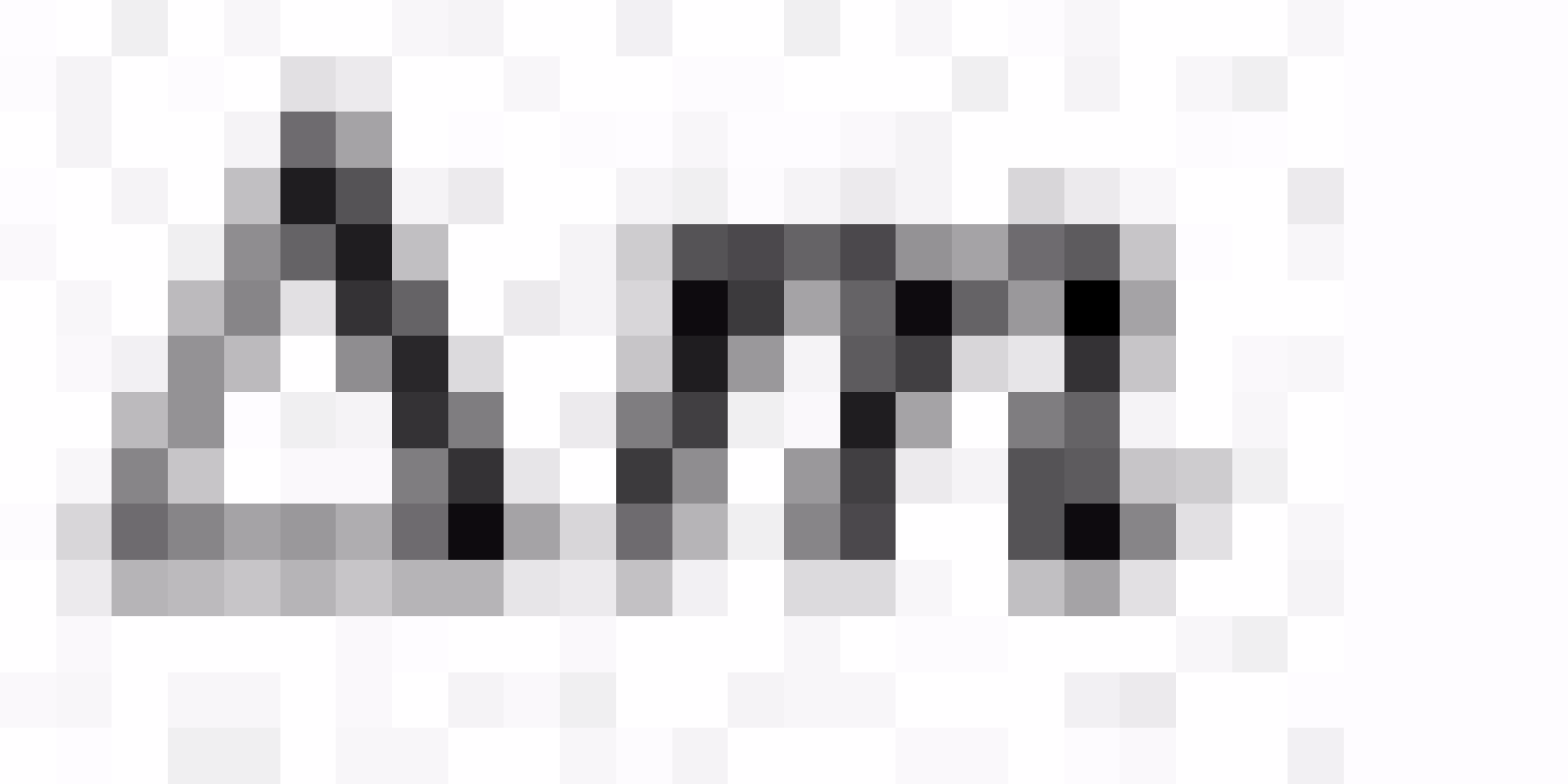

154.10

=

154.10

(54.10)

